

CATALOGO - CATALOG

2018 / 2019

INDICE - INDEX

Tabelle di Equivalenza Numerica Si riferiscono ai codici di riferimento dei fabbricanti di filtri e O.E.M.	pag. 1
Cross Reference by Number Cross reference Competitive Part and O.E.M. Part Number	
Tabelle di Equivalenza dei Costruttori Riferimenti tra fabbricanti di filtri e O.E.M. per i loro codici	pag. 55
Cross Reference by Manufacturer Cross reference Competitive Part and O.E.M. by Part. No.	
Applicazioni Principali Applicazioni, Dimensione dei filtri e Foto	pag. 107
Product Guide General Application, Dimensions and Photo	
Filtri in ordine di dimensione Filters listed by Dimension	pag. 138



POLITICA PER LA QUALITA' :
E' UN ESIGENZA E UNO STATO DI NECESSITA'

QUALITY POLICY :
IT IS NECESSARY AND A STATE OF MIND

La **Virgis Filter** considera la **Qualità** come il mezzo per soddisfare tutte le aspettative del cliente e per il miglioramento continuo della organizzazione aziendale e rappresenta, inoltre, il fulcro della nostra strategia per ottenere prodotti di qualità a prezzi competitivi.

La nostra politica di qualità è basata sui seguenti punti :

1. **Soddisfazione del cliente**
2. **Innovazione tecnica**
3. **Miglioramento continuo del prodotto e dell' organizzazione aziendale**
4. **Coinvolgimento attivo dei dipendenti**
5. **Partecipazione dei fornitori**

Virgis Filter consider **Quality** as the tool to satisfy customer expectations and to continually improve, furthermore it is key to our strategy of delivering quality products at competitive prices.

Our policy is based as follows :

1. **Customer satisfaction / Development**
2. **Innovation a technology**
3. **Continuous product and management structure improvement**
4. **Active involvement of employees**
5. **Cooperation with suppliers**

Number Finder Mfg. Name Index (Cont.)



ABBR.	MFG. NAME	ABBR.	MFG. NAME	ABBR.	MFG. NAME	ABBR.	MFG. NAME	ABBR.	MFG. NAME
AAPO	AAPCO	ARNS	ARIENS	BOLE	BOLENS		CHRYSLER EUROPE	CRNC	CRANE CARRIER
ABC	ABC BUS	ARNV	ARMY-NAVY	BOMB	BOMBARDIER		COMMER	CRNL	CRENLO
AC	AC	AROC	AERO-COACH	BOSS	LANCER BOSS		DESOTO	CROS	CROSS
ACF	ACF-BRILL	ARSD	ARMSTRONG-SIDDE-	BOSS	BOSS TRUCKS		FARGO	CRRER	CARRIER
ACM	ACME MACHINERY	ARTX	AIRTEX	BOTT	BOTTARINI		HILLMAN		TRANSICOLD
ACPC	ACCURATE	ASHI	ASAHI	BOUR	BOURGOIN		KARRIER	CRRO	CARRARO
ADV	ADVANCE MACHINE		KYOWA SHOKAI	BRAY	BRAY		PLYMOUTH	CRSL	CROSLAND
AFG	AIAG/FORD/GM	ASMO	ASIA MOTORS	BRD	BRAUD		ROOTES	CRSY	CROSLLEY
AGCH	AG CHEM	ASTM	ASTON-MARTIN	BRG	BOWSER-BRIGGS		SHELBY MOTORS	CRTR	CARTER
AGCO	AGCO	ASTR	ASTRA	BRGS	BERGSTROM		SIMCA	CRTW	CURTISS-WRIGHT
AGON	AG ONE	ATCO	ATLAS COPCO	BRGW	BORGWARD		SINGER	CSNA	CESSNA
AGRF	AGRIFUL	ATHY	ATHEY	BRGWR	BORGWARNER		SUNBEAM	CSTV	CUSTOM VACUUM
AGRI	AGRITALIA	ATIM	ATLAS-IMPERIAL	BRM	BRIMONT	CIMTK	ADMIRAL	CUB	CUB CADET
AHLM	AHLMANN	ATLAS	ATLAS	BRODR	BRODERSON		CENTRAL ILLINOIS	CUNO	CUNO
AI	ALLIED INDUSTRIES	ATLSW	ATLAS WEYHAUSEN	BROS	BROS		CENTURION	CUSH	CUSHMAN
AIPOM	AIRCRAFT POROUS	ATP	ATP	BRS	BRISTOL		CIMCO	CVTR	COVENTRY CLIMAX
AIRM	AIR MAZE	ATSA	ATSA	BRYT	BROYT		CIM-TEK	CYCG	CYCLONE GASKETS
AKER	AKERMAN	AUST	AUSTOFF	BSH	BOSCH		EMPEROR	CYCL	CYCLONE
AL	AL FILTER CO.	AUTP	AUTOPAR	BSS	BUSSING		FUELGUARD		GOULD
ALBAR	ALBARET	AUTR	AUTOMATIC	BTAE	BETAFLOW	CITR	CITROEN		PARMA
ALBN	ALBIN	AUWR	AUWAERTER		DIAGNETICS	CKR	CHECKER	CYDR	CYCLONE DRILL CO.
ALCO	ALCO	AVBA	AVELING-BARFORD	BUCYE	BUCYRUS-ERIE	CLARK	AUSTIN WESTERN	DAEW	DAEWOO
ALFA	ALFA ROMEO	AVCO	AVCO		RUSTON BUCYRUS		CLARK	DAEWK	DAEWOO KOREA
ALIS	ALLISON	AWD	AWD	BUHO	BUSH HOG		MICHIGAN	DAF	DAF
ALLC	ALLCAR	AWZ	AUTOWIZE	BULL	BULLARD		ROSS CARRIER	DAHL	DAHL
ALLIC	ALLIS-CHALMERS	B&WL	B & W LATHROP	BVR	BEAVER BUS		CLAS	DAIH	DAIHATSU
ALLO	ALCO LOCOMOTIVE	BAGR	BARBER GREEN	BWN	BOWEN		CLBR	DANA	DANA
ALND	ALONDRA	BALD	BALDWIN		CAROLINA		CLEAN	DANAS	DANA-SPICER
ALOM	ALL-O-MATIC	BARK	BARKO HYDRAULICS	CAL	CALSA		CLIN	DART	DART
ALOY	ALLOY	BARKH	BARKO HOUSINGS	CAMCO	CAMECO		CLMX		K.W.DART
ALSKD	ALASKA DIESEL	BAUD	BAUDOQUIN	CANC	CANADIAN CAR		CLRKH	DAVEY	DAVEY
	LUGGER	BAUR	BAUER	CARA	CARRARO ANTONIO		CLS	DAVS	DAVIS
	NORTHERN LIGHTS	BBB	BLUE BIRD BODY CO.	CARQ	CARQUEST		CLT	DAYT	DAYTON
ALST	ALSTHOM	BDGER	BADGER	CASE	CASE		CLTER	DCHT	DECHENTREITER
ALUP	ALUP	BEAM	BEAM		J.I. CASE		CLVL	DEER	DEERE
AMBO	AMERICAN BOSCH	BEFLS	BEHRINGER FLUID	CASEH	CASE HOUSINGS		CMC	DEERH	JOHN DEERE
AMC	AMC	BELL	BELL	CASEI	CASE/INTERNATIONA		CMCL	DEMG	DEMAG
	WIN	BEN	BENNETT	CAT	CATERPILLAR		CMI	DEMS	DEMSTER
AMDER	AMHOIST	BERI	BERING		GERLINGER		CMPR	DENSO	DENSO
AMERA	AMERICAN AIR	BGST	BRIGGS &	CAV	CAV(LUCAS-CAV)			DETDI	DETROIT DIESEL
AMERL	AMERICAN LINCOLN	BIED	BIEDERMAN	C-C	CHRIS-CRAFT			DEUTZ	DEUTZ
AMG	A M GENERAL	BIGBD	NORTHERN MFG.	CDC	CONSOLIDATED			DIGO	DIGOMAT
AMHO	AMERICAN HOIST	BITEL	BITELLI	CDRR	CEDAR RAPIDS		CMW	D-K	DAWSON-KEITH LTD
AMLF	AMERICAN LA-	BKGW	BUCKEYE-	CECH	CUMMINS HOUSINGS		CNCO	DLS	DL STEEL
AMPC	AMPPO	BKR	BAKER	CECO	CUMMINS			DMBZ	DAIMLER-BENZ
AMPT	AMERICAN PARTS	BKW	BROCKWAY	CESA	CESAB		CNFL		MERCEDES-BENZ
	BIG A	BLH	BLH	CFD	CFD (HONAN CRANE)		CNPN	DMI	DMIC
AMRE	AMERICAN ROAD &	BLHSG	BALDWIN HOUSINGS	CFM	CANADIAN FILTER		CNTL	DMIC	DELAWARE
AMS	AMS	BLKM	BLACKMER	CHAMP	ACE		CNTR	DMND	DIAMOND
AMTRS	AMERICAN MOTORS	BLKN	BLAW-KNOX		CHAMP		COCH	DMNDH	DIAMOND T
ANSL	ANSALDO	BLKW	BLACKWELDERS		KLEENER		CODV	DMNDT	DIAMOND REO
APCO	APCO	BLOUN	BLOUNT		MASTER PARTS		COFAM		DIAMOND T
APDL	ALPHA-DIESEL	BMG	BOMAG		SALEM		COMF		REO
APLKH	AP LOCKHEED	BMW	BMW	CHEQ	CHANDLER		CONTI	DMNN	DOMINION
APPR	APPROVED	BMY	BMY	CHLG	CHALLENGE		COOK	DNS	DENNIS
A-R	AIR REFRINER	BNDX	BENDIX	CHLN	CHAR-LYNN		COPB	DODGE	DODGE
ARCF	ARCTIC FOX	BNFR	BENFRA	CHMB	CHAMBERLAIN		COPR	DOMNG	DOMANGE
AREN	AIR ENERGIE	BNLI	BENELLI	CHMPI	CHAMPION		CPRH	DON	DONALDSON
ADESC	ARESCO	BNRD	BERNARD	CHNB	CHAIN BELT		CRBT	DONH	DONALDSON
ARFIL	ARMA FILTER	BNSR	BONSER	CHPN	CHICAGO-		CREP	DONIT	DONIT
ARGO	ARGO	BNTI	BENATI	CHRM	CHAMPION ROAD		CREYS	DOUG	DOUGLAS F.L.
ARMAN	ARROW	BOBC	BOBCAT	CHRY	BARREIROS		CRHT	DPLX	DUPLEX
ARMX	ARMAX	BOGE	BOGE		CHRYSLER		CRLS	DR/G	DRESSER/GALION

Number Finder Mfg. Name Index (Cont.)



ABBR.	MFG. NAME	ABBR.	MFG. NAME	ABBR.	MFG. NAME	ABBR.	MFG. NAME	ABBR.	MFG. NAME
DRMN	DORMAN			FWD	FWD	HATZ	HATZ	IHC	IHC
DROT	DROTT	FBO	FRISCH		FWD HOUSINGS	HAUL	HAULOTTE		YUMBO
DRTC	DRILTECH	FCET	FACET	FX	FOX TRACTOR	HBRT	HOBART	IHCG	IHC GASKETS
DTLN	DUTTON-LAINSON	FDFS	FORD FINISCODE	G&S	GRAFT & STILT	H-C	HART-CARTER	IHCH	IHC HOUSINGS
DTWT	DITCH WITCH	FDH	FORD HOUSING	GDDN	GARDNER-DENVER	H-D	HARLEY DAVIDSON	IHI	IHI
DTX	DITEX	FDI	FDI	GDYR	GOODYEAR	HDA	HEAVY DUTY AIR	IMGRS	MAGIRUS
DUCA	DUCATI		FILTER DYNAMICS	GE	GENERAL ELECTRIC	H-DA	HDA	IMPC	IMPACO
DUCO	DUST CONTROL		GENERAL		RUSTON HORNSBY	HDMTC	HYDRAUMATEC	IMT	IOWA MOLD
DVC	DIVCO	FDN	FODEN	GEHL	GEHL	HDRC	HYDRECO	INDR	INDENOR
DVCO	DAVCO	FDYN	FLUID DYNAMICS	GETMA	GETMAN	HDRK	HENDRICKSON	INDUC	INDUCONTO
DVDB	DAVID BROWN	FEDT	FEDERAL TRUCK	GILB	GIL-BARCO	HDSN	HUDSON	INPA	INVICTAPART
DVRI	DIVERSIFIED IND.	FIAM	FIAAM	GLDI	GOLDONI	HEDEN	HEDEN	INSL	INSLEY
DX	DELUXE	FIATH	FIAT HITACHI	GLDNR	GULDNER	HEIL	HEIL	INTER	INTERNORMEN
DXA	DIEXA	FIL	FILTREC	GLDS	GOLDEN SUPER	HENE	HENSLEY ELECTRIC	INTHV	FARMALL
DXG	DELUXE GASKETS	FILCA	FILCA	GLN	GALION	HERC	HERCULES		INTERNATIONAL
DXH	DELUXE HOUSING	FILT	FILT	GMC	BEDFORD	HESTN	HESSTON	INTM	DEARBORN
DXSP	DELUXE	FILTP	FILTER PRODUCTS		BUICK	HGST	HENGST		INTERCEPTOR
DYNAC	DYNACRAFT	FILTR	FILTREL		CADILLAC	H-H	HANOMAG	INTR	INTRUPA
DYNAP	DYNAPAC	FINI	FINI		CRUSADER		HANOMAG-	INTRS	INTERSTATE
DYNH	DYNAHOE	FINN	FINN		GENERAL MOTORS		HENSCHEL	IOWA	IOWA
ECHR	EICHER	FIRES	FIRESTONE	GMC	GMC	HHV	HARRIS HARVESTER	I-R	INGERSOLL-RAND
ECOM	ECOMAT	FIVE	FIVE STAR MFG.		OLDSMOBILE	HIAB	HIAB	IRLMP	IRLEMP
EDER	EDER	FKWA	FURUKAWA		PONTIAC	HIFI	HIFI	IRMER	IRMER & ELZE
EGG	EGGING	FLAI	FLAIR FILTRATION		SATURN	HILL	HILL	ISEK	ISEKI
ELGS	ELGIN SWEEPER	FLDQ	FIELD QUEEN		VAUXHALL	HINO	HINO	ISZ	ISUZU
ELWL	ELWELL-PARKER	FLEET	FLEETGUARD	GMCH	GMC-HOUSINGS	HLCO	HILCO	IVCO	FIAT-OM
EMCO	EIMCO	FLEZ	FLOW EZY	GMNI	GEMINI	HLDN	HOLDEN		IVECO
EMD	EMD/GENERAL	FLGA	FILGA	GNHR	GONHER	HLMT	HAULAMATIC	JAGUR	JAGUAR
ENCB	ENSIGN	FLOL	FLO-LINE	GNRAC	GENERAC CORP.	HLY	HOLLEY	JAT	JAT
ENFD	ENFIELD	FLPS	FLUID POWER	GOLD	GOLDEN FILTER	HN-C	HONAN-CRANE	JBN	JOHN BEAN
ENT	ENTERPRISE	FLR	FULLER	GORU	GORMAN RUPP	HNCK	HANCOCK	JCB	J.C.BAMFORD
ENUM	ENUMCLAW	FLRIT	FLEETRITE	GPC	GPC	HNLY	HENLEY	JCBS	JACOBSEN
EPE	EPE	FLTK	FLUITEK	GR7	GROUP 7	HNSN	HINSON	JDEER	JOHN DEERE
ERF	E.R.F.	FLTRM	FILTER MEX	GRDIN	GUARDIAN	HOFFM	HOFFMAN ALLEN		JOHN DEERE-LANZ
ERKS	ERICKSON	FLUXF	FLUXFILTER	GRDL	GRADALL	HOKE	HOKE	JEB	J.JEB
EUC	EUCLID	FLXB	FLXIBLE	GRDN	GRADNER	HOKY	HOKUETSU KOGYO	JEEP	JEEP
	EUCLID HOUSINGS	FMC	FMC	GREG	GREGOIRE	HONDA	ACURA		KAISER JEEP
EUDRO	EUROP HYDRO	FMHD	FARMHAND	GRFR	GREYFRIARS		HONDA		WILLYS
EUROF	EUROFILTER	FMLD	FARMLAND	GRHM	GRAHAM	HOUGH	HOUGH	JENES	JENBACHER
EVSK	EVASKO	FNDT	FENDT	GRSEN	GRESEN	H-P	HY-PRO	JEWE	JENBACHER WERKE
EXCL	EXCEL	FNWK	FENWICK	GRSH	GRIMMER SCHMIDT	HRFL	HYDROFILT	JGR	JAEGER
EZGO	E-ZGO CAR	FORD	FORD	GRSN	GARRISON	HRMO	HARMO	JNSN	JENSEN
F-A	MARSHALL FOWLER		LINCOLN	GRV	GROVE	HRVD	HARVARD	JNST	JOHNSTON
FACF	FAC FILTER (ARAB		ROTUNDA		MANLIFT	HS	HALL-SCOTT	JOY	JOY
FACO	FACO		TAURUS	GRVH	GROVE HOUSINGS	HSC	CANADA	JV	JACKSON
FAGL	FAGEOL	FRAD	FRAD	GRVL	GRAVELY		HAWKER SIDDELEY	KALMAR	KALMAR
FAGRI	FIATAGRI	FRAM	FRAM	GRYM	GRAY MARINE	HSP	HISPANO SUIZA	KATO	KATO
FAHR	FAHR	FRBK	FAIRBANKS - MORSE		TELEDYNE	HSW	HSW-HUTA	KAYD	KAYDON
FAI	FAI FILTRI	FRGK	FRIGIKING	GS	GIESSE	HTCH	HITACHI	KAYS	KAYSAN
FAIEX	FAI	FRHF	FRUEHAUF	GSCOR	GUASCOR	HTN	HUTCHENS	KBI	KBI
FAIK	FAI KOMATSU	FRM	FAIRMONT RAILWAY	GUD	GUD	HUP	HUPP	KBLC	KOBELCO
FALK	FALK	FRMH	FRAM HOUSINGS	GULF	CRUISEMASTER	H-W	HUBER-WARCO	KDC	KDC PARTS
FALLI	AIFO	FRNK	FRANKLIN		GULF	HYAX	HYDRO-AX	KDCH	KDC HOUSINGS
	FIAT-ALLIS	FRRI	FERRARI	GURIA	GURIA	HYCN	HYCON	KEEN	KEENE
	SOMECA	FSI	FILTRATION	GUT	GUIOT	HYCO	HYCO	KELTE	KELTEC
	UNIC	FSPA	FISPA	HAGE	HAGIE	HY-D	HY-DYNAMIC	KEM	KEM
FAML	FAMEL		IAO	HAHNI	HAHN INC.	HYDAC	HYDAC	KHD	HUMBOLT
FARLN	FAIREY ARLON	FTCL	FILTER CLONE	HAKO	HAKO	HYDR	HYDRO-CRAFT		KHD(KLOCKNER-
FARR	FARR	FTZJ	FITZJOHN	HALL	HALLA	HYGE	HYGECO	KIKU	KIKU FILTEC
FARRH	FARR HOUSINGS	FUCHS	FUCHS	HAMM	HAMM	HY-M	HYDRA-MAC	KIM	KIM
	FATE ROOT HEATH	FUNK	FUNK	HANIX	HANIX	HYMC	HYMAC	KINB	KINBY
FARY	FARYMANN	FUPR	FUEL PREPORATOR	HAST	HASTINGS	HYST	HYSTER	KINGB	KING BEARING
FAUN	FAUN- FRISCH	FURUK	MDI/FURUKAWA	HATR	HATRA	HYUN	HYUNDAI	KLBL	KAELBLE

Number Finder Mfg. Name Index (Cont.)



ABBR.	MFG. NAME	ABBR.	MFG. NAME	ABBR.	MFG. NAME	ABBR.	MFG. NAME	ABBR.	MFG. NAME
KLGA	KELLOGG AMERICAN		TRIUMPH	MICRO	MICROTER	NIMI	NIPPON MICRO	PLJOB	PEL-JOB
KLR	KOHLER		VANDEN PLAS	MIFP	AMBAC	NIPPA	NIPPARTS	P-M	MERCURY LIFT
KLVN	KELVIN		WOLSELEY	MJA	MIJACK	NIPR	NIPPON ROKAKI		PETTIBONE-
K-M	KIA MOTORS	LHA	LHA	MIOF	MIOFILTRE	NISSAN	NISSAN	PMC	P.M.C.
KMC	KENT-MOORE CORP.	LHNHS	LOSENHAUSEN	MKH	MACK HOUSINGS	NKK	NKK	PMTC	PERMATIC
KMPR	KAMPER		VIBROMAX	MLPT	MULTIPART	NLSP	NATIONAL SPENCER	PNEU	PNEUMOFOR
KMTS	KOMATSU	LIAZ	LIAZ	MLRO	MELROE	NODA	NODA	PNGLY	PINGUELY
KNCT	KNECHT	LIMA	LIMA	M-M	MINNEAPOLIS-	NORE	NOREMAT	PNS	PENNSYLVANIA
KNDS	KNUDSON	LINDE	LINDE	MMCR	MCMaster-CARR	NORM	NORMAN	PNZO	PENNZOIL
KNOR	KNORR	LION	LION	MNGLE	MENGELE	NORS	NORSEMAN	POLA	POLARIS
KOMDR	KOMATSU DRESSER	LKHD	LOCKHEED	MNPAR	MINNPAR	NPN	N P NELSON	POWBO	POWER BOSS
KORA	KORANADO	LKWD	LOCKWOOD	MNTBR	MONTABERT	NPON	JAPAN UNIVERSAL	POYA	S.A.C.M.
KRAL	KRALINATOR	LMPC	LEMPCO	MNTO	MANITOU		NIPPON	PPM	PPM
KRK	KE FILTERS	LNCA	LANCIA	MODI	MODINA	NSTAR	NUSTAR	PRC	PRINCE
	KIRKALDIE ENG.	LNDI	LANDINI	MOOG	MOOG	NUTC	NU-TECH	PRCS	PRECISE
KRMR	KRAMER	LNEC	LINCOLN ELECTRIC	MOPR	MOPAR	NWEN	NORTHWEST	PRFL	OHIO FILTER
KRNG	BUFFALO-SPRING-	LNRC	LENROC	MORBA	MORBARK	O&K	ORENSTEIN &		POWERFLO
	KOEHRING	LNSE	LEE NORSE	MORE	MORETTO	OAKES	ROUNDER	PRFX	PURFLUX
	NCK	LOED	LOED CORPORATION	MOTR	MOTOLITE	OFC	OHIO FABRICATIONS	PRIN	PRINS MOTOREN
	PARSONS	LONG	LONG	MOTRI	MOTORCRAFT	OFSA	OFSA	PRKER	PARKER
KRP	KRUPP	LOWE	LOWE MACHINE	MOTRI	MOTRIX	OHIO	OHIO LOCOMOTIVE	PRKN	PERKINS
KRSH	KERSHAW	LPCH	LAPLANTE CHOATE	MOXY	MOXY	OHSK	OSHKOSH	PRKRH	PARKER HANNIFIN
KSBR	KASSBOHRER	LPM	LPM	MP	MICRO PORE	OHSKH	OSHKOSH	PRLI	PRIME LINE
KSR	KAESER	L-RBV	LANDRE-RUHAAK BV	MPFIL	MP FILTRI	OILSP	OILWELL SUPPLY	PRMC	PERMA-COOL
KUBT	KUBOTA	LRN	LORAIN	MPPRD	MP PRODUCTS	OLMP	OLYMPIC FILTER	PRNT	PRENTICE
KUK	KUKJE MACHINERY	LSTRP	LISTER	MRCR	MERCUISER	OM	OM	PRPT	POWERPART
KUSS	KUSS		LISTER PETTER	MRION	MARION	OMC	OMC	PRSC	PORSCHE
KW	KENWORTH		PETTER	MRPY	MURPHY	OMNI	OMNI EQUIPMENT	PTI	PTI
KWSK	KAWASAKY	LTR	LAUTRETTE	MRVL	MARVEL	OMT	OMT	PURO	CO-OP
KYSR	KYSOR	LUCS	LUCAS	MSUR	MANUSUR	ONAN	ONAN		PUROLATOR
KZOO	KALAMAZOO	LUGL	LUGLI	MTBR	MATBRO	ONANH	ONAN HOUSINGS	PUROF	PUROLATOR
LACR	LACRE	LULL	LULL EQUIPMENT	MTIT	MARATHON/TITAN	OPEL	OPEL	PWRTR	POWER TRAIN
LADA	LADA	LVRDA	LAVERDA	MTM	MTM	ORION	ORION BUS	PXFIL	PX FILTRATION
LAMES	LAMES	LYCM	LYCOMING	MTPLX	METROPLEX	OTIS	OTIS MATL	PYHL	PAYHAULER
LANLI	LANSING-LINDE	LZLT	LAZORLITE	MTRC	MOTOR COACH	OTWA	OTTAWA	QIFA	QIF-AIR
LANZ	LANZ	M	M FILTER	MTSB	MITSUBISHI	OWAT	OWATONNA	QKQY	QUICKWAY SHOVEL
LAWN	LAWN BOY	M- HT	MARMON	MTU	M.T.U.	OWEN	OWENS YACHT	QS	QUAKER STATE
L-B	LANSING-BAGNALL	M&H	MANN & HUMMEL	MTWL	MOTOWLIFT	P&H	P & H	QUNC	QUINCY
LBDN	LOMBARDINI	M&J	M&J	MUIR	MUIR HILL	P&HC	HARNISCHFEGER	QUSI	QUICKSILVER
LBF	INTERFIL	M&W	M&W GEAR	MUNC	MUNCIE	PACAR	PACCAR	RAC	RACINE
	L B FILTERS	MACK	MACDON	MUST	MUSTANG MFG.CO.	PAI	P.A.I.	RACR	RACOR
LBHR	LIEBHERR		MACK	MVM	MOTORI VM	PALL	PALL	RACRH	RACOR HOUSINGS
L-BL	LINK-BELT	MACOM	MACO-MEUDON		VM	PALM	PALMER	RAGO	RAYGO
LBRF	LUBERFINER	MAHLE	MAHLE	M-W	MICRO-WEB	PANH	PANHARD	RAND	RAND
LBRH	LUBERFINER	MAHLE	MAHLE	MWM	M.W.M.	PAX	PAXMAN	RAPID	RAPID PARTS
LDR	LEADER	MAN	M.A.N.	MYR	MYERS	PB	PETERBILT	RAYMO	RAYMOND
LDRR	LEDERER	MANNG	MANN GASKETS	MZDA	MAZDA	PBR	P.B.R.	REAG	RENAULT
LDV	LDV	MARK	MARK	NW	NELSON/WINSLOW	PBRR	PATAPSCO & BACK	REED	REED
LEAC	LEACH	MAST	MASTE	NABI	NABI INC.	PCF	PACIFIC CAR &	RENA	BERLIET
LEE	LEE	M-B	MANN-BRAZIL	NANI	NANNIDIESEL	PCLN	POCLAIN		RENAULT V.I.
LENZ	LENZ	MCCOR	MCCORMICK	NAPA	NAPA	PEARL	PEERLESS		SAVIEM
LEROI	LEROI	MCFIL	MICROFILT	NASC	NASCO	PECO	PECO	RENK	RENK
	ROLINE	MCHN	MICHIANA	NATI	NATIONAL FILTERS	PENR	PENRAY	RENLT	RENAULT
LETWS	LETOURNEAU-	MDST	MIDLAND STEEL	NATL	NATIONAL MINE	PERL	PERLINI	RETEC	REGELTECHNIK
	WESTINGHOUSE	MDWS	MEADOWS	NAVIS	NAVISTAR	PERY	CLASSIC	REX	REX
LEYL	AUTHI	ME	MILLER ELECTRIC	NCCO	NALCO CHEMICAL		PERRY	REXM	REX MIXERS
	BRITISH LEYLAND	MECAL	MECALAC	NCOOL	NALCOOL	PERYH	PERRY HOUSINGS	REXN	REXNORD
	FREIGHT-ROVER	MENA	MENARINI	NEM	NEM	PEUG	PEUGEOT	REXWR	REXWORKS
	GUY	M-F	MASSEY-FERGUSON	NEOP	NEOPART	P-G	PIERCE-GOVERNOR	REYTR	REYTOR
	LEYLAND	MFP	MCELROY FLUID	NEUS	NEUSON	PGSO	PEGASO	RFCO	REFILCO
	RILEY		MICHIGAN FLUID	NEWH	NEW HOLLAND	PH66	PHILLIPS 66	RICH	RICHIER
	ROVER	MGD	MGD PNEUMATICS	NEWI	NEW IDEA	PHILL	PHILLIPS	RKL	RICKEL MFG. CO.
	SCAMELL	MHWK	MOHAWK MFG.	NGNT	NUGENT	PIPRC	PIPERCROSS	RMG	RMG FILTERS

Number Finder Mfg. Name Index (Cont.)



ABBR.	MFG. NAME	ABBR.	MFG. NAME	ABBR.	MFG. NAME	ABBR.	MFG. NAME	ABBR.	MFG. NAME
R-N	RUSSELL-	SNH	SPERRY NEW	TOMI	TOMI		BOLINDER-	YNMR	YANMAR
ROCK	ROCKWELL	SNZI	SLANZI	TORO	TORO		KOCKUM-	YSK	YSK
ROCKET	ROCKET	SOFI	SOFILTRA	TORT	TORIT		VOLVO	YT	EATON
ROGER	ROGERS	SOFM	SOFIMA	TOTAL	TOTAL SOURCE		VOLVO-BM		EATON YALE &
ROKI	TOKYO ROKI	SOFRA	SOFRALUB	TOWM	TOWMOTOR	VOLVP	VOLVO PENTA		YALE & TOWNE
ROLL	ROLLINS	SOHY	SOFIMA HYDRAULIC	TR-A	TRU-AIR	VOR	VORTEC	YUGO	YUGO
ROMA	ROMA	SOPR	SOPARIS	TRAB	TRABON	VRTX	VORTOX	YUT	MDI/YUTANI
ROMN	ROMAN	S-P	STUDEBAKER	TRAN	TRANE	VRXH	VORTOX HOUSING	ZENOR	ZENOR/SDLM
ROPA	ROL PAK	SPPS	SCRIPPS	TRANF	TRANSFRIG	W&S	WARNER & SWASEY	ZETOR	ZETOR
ROSA	ROSAEN	S-R	STAY READY	TREEF	TREE FARMER	WAGN	WAGNER MINING	ZF	ZF
ROTH	ROTH TANK	SRNS	SORENSEN	TRJN	TROJAN	WAIN	WAIN ROY	ZING	ZINGA
ROTOR	ROTORCOMP	ST	SEPARATION	TRKC	TRUCKCARE	WAKO	WAKO	ZTLM	ZETTELMAYER
ROYTK	ROYAL TEK	STAN	ROOSAMASTER	TRMBL	TRAILMOBILE	WALD	WALDON		
R-P	READY-POWER		STANADYNE	TRS	T.R.S.	WARK	WARD LAFRANCE		
RPI	ROTARY POWER	STD	STANDARD	TRUCK	FILTER TRUCK	WAUK	WAUKESHA		
RPLY	RIPLEY	STDTH	STANDARD-	TSUC	TSUCHIYA	WAUS	WAUSAU IRON		
R-PM	RUSTON PAXMAN	STER	STERLING	T-TJ	TECALEMIT-TJ	WAYN	WAYNE		
RR	ROLLS ROYCE	STGR	STEIGER	TURN	TURNER	WBCH	WABCO HOUSINGS		
RSJ	RANSOMES SIMMS	STIHL	STIHL	TWDS	TWIN DISC	WBCO	ADAMS		
RUGG	RUGGERINI	STILL	STILL	TWIN	TWIN COACH		WABCO		
RVLY	REVLEY	STLPR	STOLPER	TXCD	TUXCO CADDY	WBEL	WEBSTER ELECTRIC		
RYCO	RYCO	STNBO	STEINBOCK	TXCO	TEXACO	WCST	WEST COASTER		
S-A	ATKINSON	STP	STP	TYTA	TOYOTA	WDGT	WOODGATE		
	SEDDON-ATKINSON	STUF	STAUFF	UAC	UNITED AIR	WDSC	WOODS &		
SAKAI	SAKAI	SUBR	SUBARU	UCC	UCC HYDRAULICS	WEATH	WEATHERHEAD		
SAKU	SAKURA	SULL	SULLAIR	UD	UD	WEBB	WEBB		
SAME	SAME	SULLI	SULLIVAN	UEL	UNITED ENGINE LIFE	WERK	WERKLUST		
SAMO	SAAB MOTOR	SUMI	SUMITOMO	UFI	MISFAT	WESCU	WESTERN CULLEN		
	SAMOCHODOWYCH	SUND	SUNDSTRAND		UFI	WEST	WESTERN		
SAND	SANDERSON	SUNN	SUNNEN		UNIVERSAL FILTER	WESTB	WESTERBEKE		
SATO	SATOH	SUNO	SUNOCO	UN76	UNION 76	WGB	WGB		
SAUER	SAUER	SXB	SAXBY- TRACMA	UNID	UNI DIESEL	W-H	WHEEL HORSE		
			TRACMA	UNION	UNION JAPAN	WHG	WHITING		
SAUR	SAURER	SY	SY-KLONE	UNIP	UNIPART	WHIL	WEATHERHILL		
SAVAR	SAVARA	SZKI	SUZUKI	UNIT	UNIT RIG	WHITE	AUTOCAR		
SAYO	SSANG YONG	TALB	TALBOT	UNITC	UNIT CRANE &		AVERY		
SCANI	SCANIA	TAMRO	TAMROCK	UNIV	UNIVERSAL		CETRAC		
SCHR	SCHROEDER	TAYL	TAYLOR	UPC	UNIVERSAL POWER		COCKSHUTT		
SCOM	SCOOP-MOBILE		TAYLOR MACHINE	USM	U.S. MOTOR		OLIVER		
SCRD	SICARD	TBRG	TERBERG	UTEQ	UNITED TRACTOR &		WHITE		
SDMO	SDMO	TCM	T.C.M.	VAG	AUDI	WHSG	WHITE HOUSINGS		
SDP	STEYR-DAIMLER-	TCNC	TECNOCAR		V.A.G.	WILMR	WILMAR		
SEAG	SEAGRAVE	TCUM	LAUSON		VOLKSWAGEN	WILS	WILSON		
SEAR	SEARS		TECUMSEH/LAUSON	VALV	VALVOLINE	WING	WINGET		
SEDEM	SEDEMS	TDANO	TADANO	VAND	VANDEL	WINN	WINNEBAGO		
SEM	SEMAT	TECA	TECAFILTRES	VAPOR	VAPORMATIC	WINNC	WINN-COLEMAN		
SEPAR	SEPAR	TECF	TEC-FIL	VCE	VOLVO	WINNF	WINN FUEL		
SF	SF FILTER	TEHO	TEHO FILTER	VERMR	VERMEER	WISC	WISCONSIN		
SGMA	SIGMA	TEMRO	TEMRO	VERS	VERSATILE	WISED	WISED		
SHAF	SCHAEFF	TEREX	TEREX	VETUS	VETUS	WITT	WITTE		
SHEL	SHELL	THEGE	THE GENERAL	VHOL	VAN HOOL	WIX	WIX		
SHEP	SHEPPARD	THW	THWAITES	VIC	VIC	WIXS	WIX SIMPLE		
SHIB	SHIBAURA	TIKO	TAISCI KOGYO	VICK	PURO TEC	WOOD	WOOD BROS		
SHLU	SCHLUTER	TILLO	TILLOTSON		VICKERS	WOPU	WORTHINGTON		
SHRM	SCHRAMM	TIMBC	TIMBCO	VIRGI	VIRGIS	WP	WORLDPARTS		
SIFO	SIFO	TIPA	TIFFIN PARTS	VLCN	AQUACON	WPAC	WIPAC		
SIMS	SIMMS	TJK	TIMBERJACK	VME	VME (VOLVO	WRTHN	WORTHINGTON		
SISU	SISU	T-K	THERMO-KING	VMET	VALMET	WWOR	WELLWORTHY		
SLDAR	SEALED AIR	TMKN	TIMKEN		VALTRA-VL	XSV	XSV		
SLDP	SEALED POWER	TNT	G & H	VNGCO	VENGCO	YAMAK	YAMAKOU		
SLH	S+L+H		TENNANT	VOITH	VOITH	YAMAS	YAMASHIN		
SMBR	SAMBRON	TOKH	TOKHEIM	VOKS	VOKES	YBW	YORK-BORG-		
SMH	SYSTEMS MATERIAL	TOKYO	TOKYO	VOLV	BM-VOLVO	YELL	YELLOW COACH		
SMSUN	SAMSUNG								

Number Finder



MFRS. NO.	OUR NO. MFR	MFRS. NO.	OUR NO. MFR	MFRS. NO.	OUR NO. MFR	MFRS. NO.	OUR NO. MFR	MFRS. NO.	OUR NO. MFR
0 220 31600	ST-16488 ZTLM	0010949404	CH-12236 DMBZ	003564125	CH10-11308 RENA	017025000	CH-11210 FINI	02705568	CH10-12224 HSC
000 73 052	CH-12385 FUCHS	0010949604	CH-12980 DMBZ	003564126	SC10-11317 RENA	017026000	CH-12532 FINI	02705583	CH12-11389 HSC
000 983 9016	ST-16488 LINDE	0010A	CH-12248 BSH	003564127	SC10-11317 RENA	017027000	CH-13489 FINI	027-05583	CH12-11389 LSTRP
0000805187	CH07-14074 KRMR	0012A	CH-12242 BSH	003564128	CH-12266 RENA	017309	CH05-11106 ME	02-7074164	CH12-11389 WHITE
000-1350-4276	CH05-11106 LPM	0014A	CH-12247 BSH	003564135	CH-12282 RENA	018765	CH05-11106 ME	02-7074252	CH14-12245 WHITE
000-1350-4505	CH-12209 LPM	00164-757-01	CH09-12244 BLKN	003564137	CH16-12253 RENA	01902129	CH-12278 ALLIC	02-7074453	CH12-12251 WHITE
0001A	CH-12385 BSH	002 094 94 04	PF-15690 DMBZ	0036A	CH-12250 BSH	0199206	CH05-11106 WAUK	02-7074458	CH12-11389 WHITE
0002241034	CH-12232 RENA	002004-58	CH-12266 DRTC	0036A	CH-16874 BSH	0199421	CH09-12244 WAUK	02-7074463	CH-12262 WHITE
0003563021	CH-12278 RENA	0020940004	CH-12385 DMBZ	0038A	CH-12231 BSH	02165039	CH-12231 IVCO	02-7075128	CH16-12253 WHITE
0003563592	CH-12980 RENA	0020943304	ST-16487 DMBZ	004 051 74	CH-12385 DEMG	02165044	CH-12386 IVCO	02-7077554	CH-12268 WHITE
0003564138	SC14-12254 RENA	0020943404	CH-12231 DMBZ	004207090	CH-12386 RENA	02165049	CH-12385 IVCO	027407	CH16-12253 AGCH
0003633631	CH-12285 OMNI	0020946004	CH-12386 DMBZ	004212747	CH-12385 RENA	02165054	CH-12242 ALLIC	03401-06012	CH08-11288 FKWA
0003A	CH12-11389 BSH	0020946104	ST-13530 DMBZ	004212748	CH-12242 RENA	02165054	CH-12242 IVCO	03414540	CH-12209 CLAS
0004214489	CH-12242 RENA	0020947004	CH-12809 DMBZ	004214189	CH-12242 RENA	02165059	CH-12235 IVCO	03414590	CH-12867 CLAS
0004309015	CH-12386 RENA	0020949204	PF-15690 DMBZ	004214313	CH-12385 RENA	02168629	CH-12248 IVCO	03417790	CH05-11106 CLAS
0004A	CH-12235 BSH	0020949304	PF-15693 DMBZ	004214314	CH-12242 RENA	02241329	ST-13531 IVCO	040 050 74	CH-12386 DEMG
0005A	CH14-12245 BSH	0020A	CH-12091 BSH	0042A	CH-12232 BSH	02243946	ST-13527 IVCO	040.428	CH-12985 PNEU
0008A	CH-12386 BSH	0022004800	CH-12242 RENA	00501-03065	CH05-11106 FKWA	023408	CH06-11295 BNRD	040.436	CH-12397 PNEU
0009839010	CH-12953 GLDNR	0022860400	CH-12235 RENA	00501072	CH08-12243 JOY	023409	ST06-11315 BNRD	040.659	CH-12231 PNEU
0009839012	CH-12397 GLDNR	0022A	CH-12285 BSH	005010720030	CH08-12243 JOY	023411	CH08-11288 BNRD	040.741	CH-12385 PNEU
0009839014	CH-12231 GLDNR	0024551184	CH-12385 RENA	0050A	CH-12660 BSH	023412	ST08-11316 BNRD	040.907	CH-12888 PNEU
0009839015	CH-12386 GLDNR	0024551192	CH-12268 RENA	005-2222	CH06-11038 BNFR	023414	CH09-12244 BNRD	04003/08015	CH-12397 LHNHS
0009839016	ST-16488 GLDNR	0024A	CH-12225 BSH	005-2223	ST06-11109 BNFR	023415	ST09-12265 BNRD	04021/19504	CH-12386 LHNHS
0009839017	ST-16487 FNWK	0028A	CH12-12251 BSH	00527693	SC-12270 JOY	0-2388-1	CH05-11106 AMHO	0403756	CH12-12251 YT
0009839017	ST-16487 GLDNR	003001094830	CH-12247 DMBZ	0056A	CH-12234 BSH	023881A	CH05-11106 ASTR	041.327	CH05-11106 PNEU
0009839017	ST-16487 LINDE	0030943904	CH-11789 DMBZ	0060377200	CH-12385 RENA	02394637	ST-13529 ALLIC	041.430	CH-12235 PNEU
0009839019	CH-12285 GLDNR	0030946004	CH-14107 DMBZ	0060A	CH-12238 BSH	0239513	CH05-11106 ALLIC	041.500	CH-12278 PNEU
0009839020	ST-13531 GLDNR	0030947504	PF-15699 DMBZ	0060A	CH-12242 BSH	0239513	CH05-11106 FALLI	042-1-03	CH05-11106 BLKW
0009839331	CH05-11106 GLDNR	0030A	CH-16873 BSH	0090940502	CH-12278 DMBZ	0239518	CH05-11106 ALLIC	042-1-0370	CH05-11106 BLKW
0009931106	CH-12397 KRMR	0034A	CH-12246 BSH	01000965	SC14-12254 PERL	0240760	CH04-11675 ALLIC	042-1-37	CH05-11106 BLKW
0009931106	CH-12397 OMNI	00353264	CH-12091 HAMM	01000967	CH14-12245 PERL	02414950	ST-13530 IVCO	042-1-371	CH05-11106 BLKW
0009933006	CH-12397 HAKO	003563512	CH-12385 RENA	0105025	CH08-12243 YT	0244570	SC12-11391 ALLIC	042770	CH05-11106 WALD
0009A	CH05-11106 BSH	003563513	CH-12235 RENA	010965	CH05-11106 AREN	0244570	SC12-11391 FALLI	042796	CH05-11106 WALD
000E068-0190	CH14-12245 LANLI	003563565	CH-12386 RENA	010966	CH04-11675 AREN	0250699	CH05-11106 ALLIC	04357887	CH-12262 FALLI
000VJ5139	CH-12266 KOMD	003563570	CH-12231 RENA	0110281/11	CH-12266 PERL	0250699	CH05-11106 FALLI	0439 7234	CH-12794 KHD
001 094 5104	CH-12235 MTU	003563595	CH-12242 RENA	011806560005	CH16-12253 MWM	025092	CH08-12243 ME	044 129 620 A	CH-12285 VAG
001036061	CH21-17070 DRTC	003563608	CH-12235 RENA	011807490001	CH12-12251 MWM	025221	CH12-12251 MACO	046003	CH06-12258 BNSR
001036-53	SC21-17075 DRTC	003563616	CH-12397 RENA	01186044	CH08-11288 IVCO	0256395	CH09-12244 ALLIC	05101-06023	SC10-11317 FKWA
001036-61	CH21-17070 DRTC	003564000	CH-12262 RENA	01186046	CH-12385 IVCO	0256983	CH08-11288 ALLIC	05101-06024	CH10-11308 FKWA
0010944204	CH-12385 DMBZ	003564001	CH12-12251 RENA	01186389	CH-12242 IVCO	0256983	CH08-11288 FALLI	05201-06004	CH12-11389 FKWA
0010944604	CH-12386 DMBZ	003564024	CH05-11106 RENA	0120948402	CH-12236 DMBZ	0257597	CH05-11106 ALLIC	05201-06013	SC12-11391 FKWA
0010944704	CH-12242 DMBZ	003564087	CH-12260 RENA	0120948702	CH-12235 DMBZ	0260309	CH08-11288 ALLIC	055017	CH05-11106 GEHL
0010945204	CH-12385 DMBZ	003564105	CH08-11288 RENA	0130941502	CH-12246 DMBZ	0267075	CH09-12244 ALLIC	055574	CH08-12243 WALD
0010946504	CH-12236 DMBZ	003564106	ST08-11316 RENA	0130941702	CH-12242 DMBZ	0267931	SC10-11317 ALLIC	056014	CH05-11106 GEHL
0010947904	CH-12235 DMBZ	003564115	SC12-11391 RENA	0130941802	CH-12385 DMBZ	0267931	SC10-11317 FALLI	05730102	CH10-12224 BMG
0010948004	CH-16873 DMBZ	003564117	CH12-11389 RENA	01319822	PF-16800 DEUTZ	0267962	SC10-11317 ALLIC	05730105	SC12-11391 BMG
0010948204	CH-12231 DMBZ	003564118	CH14-12245 RENA	01522242009	CH-12208 KHD	0267962	SC10-11317 FALLI	05730106	CH09-12244 BMG
0010948304	CH-12247 DMBZ	003564119	SC14-12254 RENA	01660264	CH-12847 JOY	027-05419	CH05-11106 LSTRP	05730110	CH08-11288 BMG
0010949304	CH-12246 DMBZ	003564120	CH14-12245 RENA	017023000	CH08-11003 FINI	027-05423	CH-12262 LSTRP	05730112	ST08-11316 BMG

Number Finder



MFRS. NO.	OUR NO. MFR	MFRS. NO.	OUR NO. MFR	MFRS. NO.	OUR NO. MFR	MFRS. NO.	OUR NO. MFR	MFRS. NO.	OUR NO. MFR
05730113	SC-12274 BMG	07-3-0205-0	CH-12242 TRKC	0746-931	ST09-12265 FAUN	10/2327	CH12-11389 WHIL	10349868	CH05-11106 I-R
05730114	CH12-11389 BMG	07-3-0206-0	CH-16873 TRKC	0747-082	CH18-17230 FAUN	10000025	CH05-11106 KZOO	1035364-001	CH-12209 LANLI
05730115	SC-12274 BMG	07-3-0220-0	CH12-11389 TRKC	0747-083	SC18-17232 FAUN	10011906	CH-12385 ZETOR	1037735-M91	ST06-11315 M-F
05730116	CH12-12251 BMG	07-3-0221-0	SC12-11391 TRKC	0747-092	SC10-11317 FAUN	10011907	ST-13531 ZETOR	1040764-M91	CH06-14733 M-F
05730119	CH14-12245 BMG	07-3-0222-0	CH-12213 TRKC	0747-093	CH-12276 FAUN	1004421	CH08-12243 FALLI	1040830-M91	CH12-11389 M-F
05730120	SC14-12254 BMG	07-3-0223-0	CH-12250 TRKC	075129620A	CH-12386 VAG	10050	ST-14343 FACO	1040919-M91	SC12-11391 M-F
05730130	ST06-12048 BMG	07-3-0223-0	CH-16874 TRKC	077382.0	ST-17470 CLAS	100505-21E	CH-13074 SMBR	1041308	CH-12177 L-B
057448	CH05-11106 EXCL	07-3-0224-0	CH14-12245 TRKC	0788422	CH-12235 O&K	100505-30L	CH08-11942 SMBR	104147	SC14-12254 ASTR
057455	CH05-11106 EXCL	07-3-0225-0	SC14-12254 TRKC	07980507	SC10-11317 IVCO	1005365	CH08-12243 FALLI	1042412-M91	CH09-12244 M-F
05821012	CH-12385 BMG	07-3-0226-0	CH-12289 TRKC	0-82571	CH04-11675 CASE	100-6846	CH10-12390 CAT	1043327-M91	ST-14343 M-F
05821013	CH-12386 BMG	07-3-0227-0	CH-11211 TRKC	08304.0024	CH-12234 MAN	100-6846	CH10-14455 CAT	104412	SC-12274 ASTR
05821014	ST-13531 BMG	07-3-0228-0	CH-12283 TRKC	085319	CH08-12243 LKWD	1007973	CH08-11288 ALLIC	104516	CH12-12251 BUCYE
05821015	ST-13530 BMG	07-3-0260-0	CH-12236 TRKC	085328	CH05-11106 LKWD	1007973	CH08-11288 FALLI	104516	CH12-12251 HY-D
05821018	CH-12242 BMG	07-3-0261-0	CH-12246 TRKC	085329	CH05-11106 LKWD	100890	CH-12262 N/W	10462283	CH12-11389 P&H
05821019	ST-13527 BMG	07-3-0263-0	CH-12247 TRKC	087860	CH06-14733 GEHL	1010407	CH08-11288 ALLIC	10462329	CH14-12245 P&H
05821301	CH-12285 BMG	07-3-0280-0	ST-13531 TRKC	09-020	CH14-12245 STGR	1010407	CH08-11288 FALLI	10462335	CH10-11308 P&H
059901104	ST-12226 AGRF	07-3-0281-0	ST-13527 TRKC	09-026	CH12-11389 STGR	1011460	CH-12272 CAT	10462378	CH09-12244 P&H
059905104	ST06-11315 AGRF	07-3-0284-0	CH-12282 TRKC	09-027	SC12-11391 STGR	101158	CH-13074 O&K	10476	CH-12794 BNFR
059905104	ST06-11315 IVCO	07-3-0300-0	CH-12238 TRKC	09-029	SC12-11391 STGR	1012	CH05-12222 AMPT	10479	CH-12794 BNFR
0607B0102	CH05-11106 PBRR	07-3-0301-0	CH-12234 TRKC	09-060	CH10-11308 CASEI	101212	CH08-11942 O&K	104905	CH12-11389 H-W
063733	CH04-11675 GEHL	07-3-0320-0	CH-12278 TRKC	09-060	CH10-11308 STGR	101237	CH12-12251 N/W	10501684	CH08-11003 FRNK
0638274	CH08-11003 IVCO	07-3-0321-0	CH-12386 TRKC	0922214	PF-15688 NEWH	101275	CH05-11106 N/W	10505-06	SC21-17075 PCLN
0653785	CH05-11106 YT	07-3-0322-0	CH-12248 TRKC	092397	CH05-11467 GEHL	1014652	CH05-11467 ALLIC	1050507	CH21-17070 CASE
0654409	CH10-11308 ALLIC	07-3-0323-0	ST-13529 TRKC	092398	ST-13410 GEHL	102090	CH-12260 N/W	10505-07	CH21-17070 PCLN
0658451	CH14-12245 ALLIC	07-3-0532-0	PF-15680 TRKC	094-6081	SC14-12254 TOWM	1021006610	CH16-12253 REXN	1055493-M91	CH06-11056 M-F
0659387	CH16-12253 IVCO	07-3-0538-0	CH08-11288 TRKC	094-6353	CH12-11389 TOWM	1021006611	SC-12252 REXN	1055494-M91	ST-12226 M-F
0659533	CH14-12245 ALLIC	07-3-0540-0	CH-12781 TRKC	096-9624	CH14-12245 CAT	102264P	CH-12266 PERL	1062501-M91	CH08-11942 M-F
0660360	CH12-11389 ALLIC	07-3-0550-0	CH14-12245 TRKC	098776-8	CH10-12390 ERF	1026131-M91	CH-12209 M-F	106576	CH10-11308 DR/G
0660360/9	CH12-11389 ALLIC	0746-232	CH12-12251 FAUN	098776-8	CH10-14455 ERF	1026131-M92	CH-12209 M-F	106579	SC10-11317 DR/G
0662477	SC14-12254 ALLIC	0746-237	CH12-12251 FAUN	0991322	CH06-11255 CESA	1026161-M91	CH-12209 M-F	106579	SC10-11317 KOMD
0662607	CH16-12253 ALLIC	0746-369	CH-12385 FAUN	0991323	SC06-11246 CESA	1026191-M91	CH-12209 M-F	106587	CH12-11389 N/W
0662608	SC10-11317 ALLIC	0746-383	CH-12386 FAUN	0991673	CH06-11295 CESA	1028	ST-12226 AMPT	106769	CH14-12245 N/W
0662609	SC12-11391 ALLIC	0746-385	CH-16873 FAUN	0991674	ST06-11315 CESA	10281780	CH08-12243 REXN	106775	SC14-12254 N/W
0667685	SC-12274 ALLIC	0746-389	CH-12278 FAUN	09917419	CH12-12251 IVCO	102817801	CH08-12243 REXN	106834	SC12-11391 N/W
0667690	CH-12273 IVCO	0746-395	CH-12266 FAUN	09921320	CH12-11389 IVCO	1029	CH-12268 AMPT	1070329-M91	CH06-11056 M-F
0675911	CH14-12245 GMC	0746444	CH-12242 DEMG	09923130	CH12-11389 IVCO	1030-0659	CH-12249 ATCO	10722-21400	CH10-12224 HINO
0684732	CH10-11308 ALLIC	0746-444	CH-12242 FAUN	09927604	CH08-11288 IVCO	1030-0832	CH-12249 ATCO	1073508-M91	ST-12226 M-F
0684732	CH10-11308 FALLI	0746-547	SC-12270 FAUN	09932594	CH09-12244 IVCO	1030-1070	CH-12249 ATCO	1077A12300	CH12-12251 CMPR
0684733	CH12-11389 ALLIC	0746-554	ST08-11316 FAUN	09933276	CH14-12245 IVCO	103059	CH08-12243 YT	107868	CH08-11288 N/W
0684734	CH14-12245 ALLIC	0746-555	CH08-11288 FAUN	09981555	ST09-12265 IVCO	1031436-M91	CH05-11106 M-F	1078A30930	CH14-12245 CMPR
0691733	CH-12231 DAF	0746-712	ST-13531 FAUN	09983764	CH-12235 IVCO	1031885-M1	CH12-12251 M-F	1078A31300	CH12-11389 CMPR
070129620	CH-12397 VAG	0746-713	CH21-17070 FAUN	0DA551/4	CH-12177 GE	1031885-M91	CH12-12251 M-F	107974	ST08-11316 ALLIC
0702016	CH-12268 GMCH	0746-714	SC21-17075 FAUN	0L551E/4	CH12-11389 GE	1031PL	CH08-12243 GLDS	1080920	ST-16938 VOLV
070-905	CH-12278 CLAS	0746-718	SC-12274 FAUN	0L551H/4	CH-12262 GE	103258	CH14-12245 KOMD	1084	CH-12249 AMPT
071-242	CH-12278 CLAS	0746-725	CH-12231 FAUN	0L551M/4	CH12-12251 GE	103259	SC14-12254 DR/G	108668	CH10-11308 N/W
072239.0	ST-13528 CLAS	0746-910	CH-12397 FAUN	0L551N/4	CH14-12245 GE	103259	SC14-12254 KOMD	108674	SC10-11317 N/W
07-3-0202-0	CH-12235 TRKC	0746-911	CH-16873 FAUN	1987430056	CH-12234 BSH	1032762-M91	CH05-12222 M-F	1089	CH-12260 AMPT
07-3-0203-0	CH-12385 TRKC	0746-916	CH14-12245 FAUN	1987430060	CH-12238 BSH	1033	PF-15677 AMPT	1089774-M91	CH14-12245 M-F
07-3-0204-0	CH-12264 TRKC	0746-928	CH-12278 FAUN	1.457.433.900	CH-14900 BSH	10349866	CH05-11106 I-R	1089937-M91	SC14-12254 M-F

Number Finder



MFRS. NO.	OUR NO. MFR	MFRS. NO.	OUR NO. MFR	MFRS. NO.	OUR NO. MFR	MFRS. NO.	OUR NO. MFR	MFRS. NO.	OUR NO. MFR
1090109-M91	CH12-11389 M-F	111140191030	CH-12231 FAHR	118H/1144	CH14-12245 I-R	1238.27.07	CH-13818 SOFI	1267.05.00	CH06-11941 SOFI
1090110-M91	SC12-11391 M-F	111140203040	ST-13530 FAHR	118H/1154	CH12-11389 I-R	1238-02	CH08-12221 SOFI	1267.06.00	CH-13270 SOFI
10906043	CH12-12251 LEYL	111140203060	CH-12386 FAHR	1181296	ST09-12265 ALLIC	1238-0700	CH-13811 SOFI	1267-01	CH-13270 SOFI
10906053	CH14-12245 LEYL	111202	CH05-11106 H-W	118158	CH-12262 NW	1238-11	CH08-11003 SOFI	1267-05	CH06-11941 SOFI
10906079	CH12-11389 LEYL	111340	CH-15673 ASTR	118216	SC14-13357 NW	1238-16	CH08-11288 SOFI	1267-06	CH-13270 SOFI
109085	SC-12274 NW	111341	SC-15681 ASTR	1183993	SC10-11317 ALLIC	1238-17	CH08-11288 SOFI	1268.09.00	CH08-11935 SOFI
109200	CH-12269 NW	113129620A	CH-12397 VAG	1183993	SC10-11317 FALLI	1238-23	CH08-11288 SOFI	1268-6807	CH08-14703 SOFI
109206	SC-12270 NW	1134	CH-12262 AMPT	1186044	CH08-11288 KHD	1239-22	CH09-12244 SOFI	1269652-C1	CH04-11675 CASEI
1093	CH14-12245 AMPT	113538	CH06-14733 NW	1186046	CH-12385 KHD	1240-05	CH10-11117 SOFI	1270-01	CH-12262 SOFI
1093682-M91	CH08-11288 M-F	1140887	CH08-12243 FALLI	1190153	CH08-12243 WHITE	1240-15	CH10-11117 SOFI	1270-02	CH10-11308 SOFI
1093683-M91	ST08-11316 M-F	1140889	CH05-11106 ALLIC	119410	ST08-11316 NW	124066-12510	CH04-11675 YNMR	1270-11	CH10-12224 SOFI
1093683-M92	ST08-11316 M-F	1140889	CH05-11106 FALLI	119538	CH06-14733 NW	1242-01	CH12-12251 SOFI	1270-12	CH12-12251 SOFI
1093686-M91	ST08-11316 M-F	114113900	CH12-12251 BOMB	1196112	CH05-11106 BRM	1242-05	CH12-11388 SOFI	1270-13	CH12-11389 SOFI
1096416-M91	CH16-12253 M-F	11420-11180	PF-15703 KUBT	119-61202000	CH10-11308 KATO	124326	CH08-12243 KRNG	1270-14	CH-12268 SOFI
1096417-M91	SC-12252 M-F	1-14215007-0	CH12-11389 ISZ	1196733	CH08-12243 WHITE	124348	CH12-12251 KRNG	1270-22	CH10-11308 SOFI
1096475-M91	ST09-12265 M-F	1-14215-007-1	CH12-11389 ISZ	11992462-9	CH-12980 VOLV	124366	CH08-12243 KRNG	1272-02	CH12-11389 SOFI
1097001-M91	CH-12266 M-F	1-14215-007-2	CH12-11389 ISZ	119925	CH-16294 ASTR	1245-01	ST05-11108 SOFI	1272-03	CH-12262 SOFI
10A-19708	CH08-12243 WHITE	1-14215-014-0	CH05-11106 ISZ	119926	SC-16301 ASTR	1246-01	ST06-11109 SOFI	1272-22	CH12-11389 SOFI
10CX-49	CH12-12251 CLMX	1-14215-033-0	SC14-12254 ISZ	12000189	CH14-12245 VOLV	1246-02	ST06-11315 SOFI	1273-55	CH-12268 SOFI
10P-2652	CH12-12251 WHITE	1-14215034-0	SC14-12254 ISZ	1201734-H1	SC14-12254 KOMD	1246-03	ST06-11109 SOFI	1274.22.00	CH14-12245 SOFI
11.3331	CH05-11106 T-K	1-14215046-0	CH14-12245 ISZ	120281	CH05-11467 NW	1246-0700	ST-15557 SOFI	1276-22	CH16-12253 SOFI
11005897	PF-15686 VME	1-14215-046-1	CH14-12245 ISZ	120501-3	CH04-11675 SIFO	1247-0107	ST07-14270 SOFI	1278	CH-12272 AMPT
11005897-1	PF-15686 VME	1-14215-047-0	SC12-11391 ISZ	1209	CH09-12244 AMPT	1248-02	ST08-11316 SOFI	127A	CH-12177 GRFR
11007388	PF-15686 VCE	1144	CH-12385 SULL	1210	ST09-12265 AMPT	1248-0700	ST-14183 SOFI	128407	CH18-17230 NW
11007388-9	PF-15686 VCE	11453900	CH-16294 WRTH	121060201770	CH-12231 FAHR	1248-17	ST08-11316 SOFI	129040	CH08-12243 FORD
1102149	CH08-11288 O&K	114650-12591	CH-16888 YNMR	121070201950	CH-12385 FAHR	1248-6807	ST08-14708 SOFI	129-340-0332	CH18-17230 SISU
11033129	ST-13528 VME	114747	CH08-12221 NW	121070203340	CH-12242 FAHR	1249-02	ST09-12265 SOFI	129-340-0342	SC18-17232 SISU
11033129-5	ST-13528 VOLV	1149	SC21-17075 AMPT	121070203350	ST-13527 FAHR	124909	CH10-11308 O&K	1293400401	CH-15300 SISU
11033777	ST-13530 VME	1150	CH21-17070 AMPT	1211071	CH04-11675 NEUS	1250-01	ST10-11239 SOFI	1295090	CH-16689 DAF
11033777	ST-13530 VCE	115209-H2	CH-12262 HOUG	121120-12001	CH-14393 YNMR	1252-01	ST12-11390 SOFI	1296	PF-15684 AMPT
11033777-1	ST-13530 VCE	1153	CH-13141 AMPT	121120-12901	CH05-11106 YNMR	1252-02	SC12-11391 SOFI	1297646	CH05-11106 YT
11033779	ST-13531 VME	115548-H45	CH04-11675 KOMD	1212	ST06-11315 AMPT	12538	CH-12269 TNT	12X20956-A	CH-12275 JDEER
11033779-7	ST-13531 VOLV	11564	SC-12274 CHRM	12122-012901	CH05-11106 YNMR	1254	CH06-11056 AMPT	12X20957-A	CH08-12221 JDEER
11033781	ST-13527 VME	11564	SC-12274 DMNN	121230202360	ST-13531 FAHR	1254.02.00	SC14-12254 SOFI	13.21840	ST-13531 KALMA
11033781-3	ST-13527 VOLV	11565	CH-12273 DMNN	121256-12510	CH05-11106 YNMR	1256-02	SC-12252 SOFI	130022	CH05-11106 SIFO
11033783	ST-13529 VME	1156603	CH08-12243 WHITE	121420-12511	CH05-11106 YNMR	1257.35.00	ST06-12048 SOFI	130771	CH-14104 NW
11033783-9	ST-13529 VOLV	11-5692	CH04-11675 T-K	121520-12510	CH04-11675 YNMR	1258	ST-14343 AMPT	1310	PF-15683 AMPT
11033783-9	ST-13529 VOLV	1163766	CH12-11389 KHD	121922-12510	CH08-11288 YNMR	125846	CH05-11106 HYST	131063680	CH-14388 FIATH
11033996	CH-16294 VCE	1169	CH05-11467 AMPT	1235-01	CH05-11106 SOFI	1259	SC10-11317 AMPT	131346	CH06-11056 NW
11033996-7	CH-16294 VOLV	1169024	CH06-11295 KHD	1235-02	CH05-12222 SOFI	1261-01	CH-12091 SOFI	131350	SC10-11317 NW
11033997	SC-16301 VCE	1169116	CH08-11288 KHD	1235-11	CH05-11106 SOFI	1262-01	CH-12285 SOFI	1316	CH-12209 AMPT
11033997-5	SC-16301 VOLV	1169117	ST08-11316 KHD	1236.66.43	CH06-11880 SOFI	126-340-0241	CH-16873 SISU	1318209	CH05-11106 ATLSW
110376	CH-16873 DAF	1170	CH06-14733 AMPT	1236-0700	CH-13824 SOFI	1264	CH14-13356 AMPT	131852	CH08-11003 GEHL
1105717-C1	CH08-11288 CASEI	117-0781	CH-12235 FAUN	1236-11	CH06-11038 SOFI	1265	SC14-13357 AMPT	131853	ST08-11110 GEHL
1106326	CH08-17365 CAT	117092	CH-12282 NW	1236-15	CH06-11295 SOFI	1265-97	CH06-12258 SOFI	131896/5	CH-12242 ERF
1106331	ST08-14413 CAT	117781	SC21-17075 NW	1236-22	CH06-11295 SOFI	1266091-H1	CH14-12245 KOMD	1335678	CH-14902 SCANI
11110022	CH-14888 VOLV	117797	CH-12268 NW	1237-0107	CH07-14865 SOFI	126652-12620	CH12-11389 YNMR	1335679	CH-14896 SCANI
11110023	SC-16290 VCE	118H/1106	CH12-12251 I-R	123730	CH05-11106 HYST	126654-12620	SC14-12254 YNMR	133747	CH-12262 CECH
11110149	ST-13531 VCE	118H/1111	CH-12262 I-R	1238.27	CH-13818 SOFI	126654-12630	CH14-12245 YNMR	133750	CH-12262 CECO

Number Finder



MFRS. NO.	OUR NO. MFR	MFRS. NO.	OUR NO. MFR	MFRS. NO.	OUR NO. MFR	MFRS. NO.	OUR NO. MFR	MFRS. NO.	OUR NO. MFR
133756	CH-12262 CECO	1410903	CH05-11106 L-BL	145142	PFM-14095 O&K	147-0702	CH-12242 FAUN	151849149	ST08-14413 FIATH
1338	CH-12177 AMPT	1410910	CH05-11106 JBN	1451794	SC10-12395 O&K	147-0703	ST-13527 FAUN	151849501	CH06-11255 FIATH
13400-13	CH05-11106 RAGO	1410910	CH05-11106 L-BL	14-5315	CH-12798 GURIA	147-0717	ST-13529 FAUN	151849501	CH06-11255 NEWH
134200-20	CH05-11106 RAGO	1415870	ST-13529 O&K	14-5317	SC10-12395 GURIA	147-0718	CH-12235 FAUN	151849502	SC06-11269 FIATH
134200-52	CH08-12243 RAGO	1416129	CH08-12243 L-BL	1454260	SC14-12254 O&K	147-0721	ST-13528 FAUN	151849502	SC06-11269 NEWH
134200-89	CH10-12224 RAGO	1416433	CH-12242 FAUN	1455283	CH-12604 O&K	147-0731	ST-16488 FAUN	152071	CH-12262 GDDN
1345A	ST-14787 GRFR	1416434	ST-13527 O&K	1455327	CH-12605 O&K	147-0823	CH-12232 FAUN	15221-11223	CH04-11675 KUBT
1348726	CH06-16050 CAT	141790	CH-12397 STILL	145700	CH14-12245 NW	1471158	CH-16294 O&K	15222-11220	CH04-11675 KUBT
1352670	CH04-11675 HYST	1420740-M91	CH08-11288 M-F	1457429032	CH-11348 BSH	1471159	SC-16301 O&K	15222-11221	CH04-11675 KUBT
136390	CH-12209 NW	1421021	CH-14902 SCANI	1457429034	CH-12213 BSH	1476636	CH-14900 O&K	15222-11223	CH04-11675 KUBT
136399	CH-12212 NW	1421022	CH-14896 SCANI	1457429035	CH-16873 BSH	1480-104-207C	CH05-12202 ISEK	15222-11224	CH04-11675 KUBT
1369809	CH05-11106 HYST	1421340	CH-16922 CAT	1457429039	CH-12660 BSH	149534	CH05-11106 DAVS	15227-11221	CH04-11675 KUBT
138169	CH12-12251 FORD	14215-006	CH10-12224 ISZ	1457429073	CH-12250 BSH	1498	CH08-11288 AMPT	1523749	CH-12775 CHMPI
1386	CH-12282 AMPT	1426098	CH-12276 O&K	1457429073	CH-16874 BSH	1499359	CH-11348 FDFS	15240188	CH-16294 TEREX
138641	CH08-12243 FORD	1427-101-014C	CH-13297 ISEK	1457429930	CH-12209 BSH	1499654	ST-13528 O&K	152553	CH05-11106 DAVS
1387548	CH-16922 SCANI	142710128400	CH04-11675 ISEK	1457429941	CH-12231 BSH	1499655	ST-12226 O&K	15270188	CH-16294 TEREX
1391-23-603	CH-12215 MZDA	14279911	CH08-12243 OTIS	1457429942	CH-12091 BSH	1499661	ST-16488 O&K	15270189	SC-16301 TEREX
13943951	CH05-11106 OTIS	1428	CH-12268 AMPT	1457429944	CH-12285 BSH	1499681	CH-12250 O&K	152776	CH-12262 HOUG
1-39439-5-1	CH05-11106 BKR	1428739-M91	CH06-11295 M-F	1457429945	CH-12225 BSH	1499681	CH-16874 O&K	152776-H1	CH-12262 IHCH
140-0765	CH05-11106 ONAN	1428745-M91	CH10-11308 M-F	1457429946	CH-12386 BSH	1499695	CH-12278 O&K	15287-11080	CH05-11106 KUBT
140-1248	CH04-11675 ONAN	1428747-M91	SC10-11317 M-F	1457429950	CH-12385 BSH	1499704	CH-12660 O&K	15287-11081	CH05-11106 KUBT
140-1251	CH04-11675 ONAN	1428748-M91	CH08-11288 M-F	1457429966	CH-12242 BSH	1499708	CH-12238 O&K	15295	CH-12273 WIX
140-1540	CH06-14733 ONAN	1429717-M91	CH10-11308 M-F	1457429967	CH-12248 BSH	1499709	CH-16873 O&K	15319-11221	CH04-11675 KUBT
140-1617	CH10-11308 ONAN	1429718-M91	SC10-11317 M-F	1457429968	CH-12234 BSH	1499714	CH-12278 O&K	15321-11011	CH04-11675 KUBT
140-1618	SC10-11317 ONAN	1433650-M92	ST08-11316 M-F	1457429969	CH-12278 BSH	1499724	CH-12236 O&K	15321-11221	CH04-11675 KUBT
140-1619	CH08-11288 ONAN	1435408-M92	CH-12240 M-F	1457429975	CH-12235 BSH	1499730	CH-12232 O&K	15328-11221	CH04-11675 KUBT
140-1620	ST08-11316 ONAN	143644	CH12-12251 FORD	1457429976	CH12-11389 BSH	1499743	CH08-12221 O&K	153712	CH-12262 CECO
140-1621	CH09-12244 ONAN	1443	CH-12206 AMPT	1457429977	CH14-12245 BSH	1499747	CH-12285 O&K	15401-11080	CH05-11106 KUBT
140-1622	ST09-12265 ONAN	1444-101-3700	CH-13296 ISEK	1457429979	CH-12826 BSH	1499752	CH06-11056 O&K	154012	CH-12260 CECO
140-1851	CH05-11467 ONAN	1447	SC10-12395 AMPT	1457429980	CH-12236 BSH	1499756	CH-12091 O&K	1542743	CH-12283 VOLV
140-1932	CH10-12224 ONAN	1447316	CH-11211 O&K	1457429982	CH-12264 BSH	1500127-00	CH05-11106 YT	1542743-8	CH-12283 VOLV
140-2328	CH04-11675 ONAN	1448074	CH-12247 O&K	1457429985	CH-12246 BSH	1500229-00	CH-12209 YT	154410420200	CH-12694 ISEK
1402337	ST06-16054 CAT	1448075	CH-12246 O&K	1457429990	CH-12249 BSH	1500231-00	CH05-11106 YT	1544298	CH-12302 VOLV
140-2762	CH-12867 ONAN	1448081	CH08-11288 O&K	1457429991	CH-12247 BSH	1500716-00	CH05-11106 YT	1544298-1	CH-12302 VOLV
140-3119	CH06-16050 ONAN	1448534	CH14-12245 O&K	1457429999	CH-11211 BSH	1501725	CH12-12251 FRNK	1544428	CH-11211 VOLV
1408296	CH-12273 O&K	1448535	CH16-12253 O&K	1457866	CH-12271 O&K	1502071	CH-12262 GDDN	1547	ST08-11316 AMPT
1408297	SC-12274 O&K	1448987	PF-15686 O&K	1457867	CH-12272 O&K	1503857	CH10-11308 CLARK	154818	CH08-12243 HYST
1409265	CH08-12243 L-BL	1448989	CH05-11106 O&K	1457879	CH-12210 O&K	1505-49	CH12-12251 PCLN	1550	PF-14090 AMPT
140P-1002	PF-14090 ONAN	1449408	CH-12208 O&K	146290	CH05-11106 DAVS	150726	CH-12269 GDDN	1550	PFM-14095 AMPT
140P-1002	PFM-14095 ONAN	1449409	CH-13157 O&K	1463932	CH-13141 O&K	1507449	CH-12262 CECO	155010420200	CH-13294 ISEK
140-P1248	CH04-11675 ONAN	1449410	ST06-11109 O&K	146939-R1	CH-12386 CASEI	150836	CH12-12251 HYST	155209-H2	CH-12262 CASEI
140-P1251	CH04-11675 ONAN	1449429	ST-16487 O&K	147-0629	CH-12385 FAUN	15104-11080	CH05-11106 KUBT	1553966	PF-14090 GMC
140-P721	CH05-11106 ONAN	1449527	CH14-12245 O&K	147-0630	ST-13531 FAUN	1514669	SC-12252 CLARK	1553966	PFM-14095 GMC
140-P765	CH05-11106 ONAN	1449640	CH-12953 O&K	147-0631	CH-12386 FAUN	151570	SC14-12254 MOXY	155748	CH12-12251 HYST
140P-842	CH04-11675 ONAN	1450012	CH-12282 O&K	147-0634	ST-13530 FAUN	151571	CH14-12245 MOXY	15581-11081	SC-12274 KUBT
1410546	CH12-12251 JBN	1450231	CH09-12244 O&K	147-0637	CH-12235 FAUN	151607	CH-12262 CECH	15586695	CH-12268 GMC
1410546	CH12-12251 L-BL	1450585	CH-12214 O&K	147-0661	ST08-11316 FAUN	151612	CH-12260 CECH	15586696	CH-12268 GMC
1410549	CH12-12251 JBN	1450586	CH-13156 O&K	147-0695	CH-12235 FAUN	151849134	CH08-11942 HTCH	1560-103-202-	CH-12716 ISEK
1410903	CH05-11106 JBN	145142	PF-14090 O&K	147-0696	CH-12278 FAUN	151849148	CH08-17365 FIATH	1560-103-202-	CH-15512 ISEK

Number Finder



MFRS. NO.	OUR NO. MFR	MFRS. NO.	OUR NO. MFR	MFRS. NO.	OUR NO. MFR	MFRS. NO.	OUR NO. MFR	MFRS. NO.	OUR NO. MFR
15606-11080	CH06-11038 KUBT	1616513	CH05-11106 CLARK	16546-95003	CH12-12251 NISAN	1698375-M1	SC06-11252 M-F	17801-1110A	CH14-12245 HINO
15606-96015	CH10-11308 KUBT	1619-1296	CH-12262 ATCO	16546-95010	ST09-12265 NISAN	1698675M2	CH-13510 M-F	17801-1180	SC12-11391 HINO
15612-11180	ST-14343 KUBT	1619-1613	CH-12212 ATCO	16546-96003	CH10-11308 NISAN	1698676-M1	CH-13520 M-F	17801-1180A	SC12-11391 HINO
156292	SC-12274 GDDN	1619-1879	CH12-12251 ATCO	16546-96010	SC12-11391 NISAN	1698679-M1	CH-12491 M-F	17801-1190	CH12-11389 HINO
156296	SC-12274 GDDN	1619-2796	CH-12231 ATCO	16546-96011	CH12-11389 NISAN	1698680-M1	CH-12485 M-F	17801-1190A	CH12-11389 HINO
156297	CH-12273 GDDN	1619-2797	CH-12386 ATCO	16546-96014	SC14-12254 NISAN	1699779-M1	CH-12491 M-F	17801-2020	CH-12273 HINO
1564	PF-15684 AMPT	1619-2798	CH-12242 ATCO	16546-96015	CH10-11308 NISAN	1699780-M1	CH-12485 M-F	17801-2030A	SC10-11317 HINO
1564805	SC-12270 CLARK	1619-2798-00	CH-12242 ATCO	16546-96016	CH12-11389 NISAN	16F94	CH08-11288 BAGR	17801-2040A	CH10-11308 HINO
1564806	CH-12269 CLARK	1619-2799	CH-12235 ATCO	16546-96026	CH10-11308 NISAN	170044	CH08-11935 GREG	17801-2260	CH-12273 HINO
156768	CH12-12251 CECH	1619-2799 00	CH-12235 ATCO	16546-96027	CH12-11389 NISAN	170046	CH-12225 GREG	17801-2270	CH-12273 HINO
156769	CH12-12251 CECH	1619-2847	CH-12385 ATCO	16546-96028	CH10-11308 NISAN	1704269	CH05-11106 CLARK	17801-2290	CH-12273 HINO
156-946-109	CH-12232 H-H	1619-2847 00	CH-12385 ATCO	16546-96029	CH12-11389 NISAN	170681	CH08-12243 HYST	17801-87601	CH08-11837 DAH
156947	CH-12262 HYST	1619-2867	CH-12397 ATCO	16546-96060	CH12-12251 NISAN	170A	CH-11348 GRFR	178624	SC14-12254 MENA
1572-103-250-	CH-14047 ISEK	1619-2997	CH-12386 ATCO	16546-96125	CH14-12245 NISAN	171022-12530	CH04-11675 YNMR	178625	CH14-12245 MENA
1574	CH12-11389 AMPT	1619-3711	CH-12268 ATCO	16546-97009	CH12-11389 NISAN	172.00329	CH-12397 ALUP	178637	CH14-12245 O&K
15741-11080	CH-12716 KUBT	1619-5327-00	ST-13531 ATCO	16546-97015	CH12-11389 NISAN	172.07794	CH-14746 ALUP	178638	SC14-12254 O&K
15741-11083	CH-12716 KUBT	1619-5441	ST-16487 ATCO	16546-99015	SC-12274 NISAN	172121	CH12-12251 CLMX	179930	CH12-12251 HYST
1575	SC12-11391 AMPT	1619-5545-00	ST-13527 ATCO	16546-99204	ST06-11109 NISAN	1727868	CH08-12243 CLARK	179948	CH05-11106 HYST
157959-AS	CH08-12243 WHITE	1619-5698	ST-13529 ATCO	16546-25001	CH10-12224 NISAN	1729-705-015-	PF-16892 ISEK	179955	CH08-12243 HYST
1581	CH18-17230 AMPT	1619-5698-00	ST-13529 ATCO	16546-25003	SC10-12395 NISAN	172994	CH-12273 GDDN	1804507-M91	CH04-11675 M-F
1582	SC18-17232 AMPT	1619-5699	ST-13528 ATCO	16546-25004	CH10-11308 NISAN	172995	CH-12266 GDDN	1807257-M1	CH-12209 M-F
1584575	PF-15686 VCE	1619-5699-00	ST-13528 ATCO	16546-25025	CH10-11308 NISAN	17325-11080	CH05-11106 KUBT	1823386	CH-12209 DFDS
1584575-3	PF-15686 VOLV	161WA-653	CH12-12251 CLARK	16546-25026	CH10-11308 NISAN	173260	CH-14107 PGSO	183A	CH-12397 TEHO
158876	CH10-12224 CECO	1621646-M91	CH06-11295 M-F	1660375	CH-11211 VOLV	17351-11080	CH-12775 KUBT	184379	CH-12262 CECH
159089-A	CH08-11288 WHITE	1624567	CH08-12243 CLARK	1660375-5	CH-11211 VOLV	17351-11083	CH-12775 KUBT	1849104	CH10-11308 BNTI
1594	ST08-11110 AMPT	16271-11080	ST-16872 KUBT	1660602	CH-12289 VOLV	173837	CH12-12251 FORD	1849105	SC10-11317 BNTI
1599	ST-13410 AMPT	162814-AS	CH08-12243 WHITE	1660602-2	CH-12289 VOLV	17580	CH08-12243 ENUM	1849106	CH14-12245 BNTI
15A-339	CH05-11106 MDWS	162860	CH09-12244 JEWEL	1660619	CH-12283 VOLV	176 168.0	ST-13531 CLAS	1849107	SC14-12254 BNTI
15A-339	CH05-11106 MLRO	16306	SC-12270 CHRMM	1660619-6	CH-12283 VOLV	176-168	ST-13531 CLAS	1849108	CH12-11389 BNTI
15A-339	CH05-11106 MRCR	16306	SC-12270 DMNN	166068-A	SC10-12395 WHITE	176-169	ST-13530 CLAS	1849109	SC12-11391 BNTI
15A-739	CH05-11106 MDWS	16307	CH-12269 CHRMM	1661667	CH-12093 VOLV	176169.0	ST-13530 CLAS	1849111	ST08-11316 BNTI
15A-739	CH05-11106 MLRO	16307	CH-12269 DMNN	1661667-4	CH-12093 VOLV	177046.0	CH-12242 CLAS	1849112	CH08-11288 BNTI
15A-739	CH05-11106 MRCR	1633719-M1	CH-14334 M-F	167067-A	CH10-11308 WHITE	177129	CH-13824 MNTO	1849116	CH-12266 BNTI
15H-665	CH05-11106 MDWS	1635988-M91	CH-12485 M-F	167068-A	SC10-12395 WHITE	177130	CH-13811 MNTO	1849117	CH10-12224 BNTI
15H-665	CH05-11106 MLRO	1635989-M91	CH-12498 M-F	1678294-M1	CH-12491 M-F	177178	ST-15557 MNTO	1849119	CH06-11295 BNTI
15H-665	CH05-11106 MRCR	164090	CH05-11106 FORD	1678295-M1	CH-12485 M-F	177179	ST-14183 MNTO	1849121	SC14-12254 BNTI
15H-668	CH05-11106 CLARK	164090	CH-12262 HOUG	1678296-M1	CH-12491 M-F	17731-41830	CH04-11675 TYTA	1849124	ST06-11315 BNTI
15H-668	CH05-11106 MDWS	164090-H1	CH-12262 IHCH	1678308-M91	CH-12498 M-F	17731-41830-7	CH04-11675 TYTA	1849125	CH09-12244 BNTI
15H-668	CH05-11106 MLRO	1642645	CH05-11106 CLARK	169468	CH05-11106 MNTO	17732-41830	CH04-11675 TYTA	1849126	ST09-12265 BNTI
15H-668	CH05-11106 MRCR	1644-333-M1	CH-14334 M-F	169470	SC12-11391 MNTO	17741-23600-7	CH-15475 TYTA	1849133	CH-12798 BNFR
15PS-2690	CH08-12243 CHPN	1644334-M1	CH-14340 M-F	169471	ST08-11316 MNTO	17743-236007	CH-15475 TYTA	1849438	CH08-11935 BNTI
160017	CH-12262 CECH	16506-96015	CH10-11308 NISAN	169472	CH08-11288 MNTO	17743-23600-7	CH-15475 TYTA	185-2090	CH04-11675 ONAN
16006108	CH05-11106 FRBK	16506-96015	CH10-11308 SZKI	169473	CH-12653 MNTO	17791-11120	SC-12274 TYTA	1852569	PF-14090 CHRYSLER
16006114	CH05-11106 FRBK	1654602K00	CH-12870 NISAN	169476	CH12-11389 MNTO	17791-11120-7	CH05-11106 TYTA	1852569	PFM-14095 CHRYSLER
160170	CH-12262 WHITE	165461G000	CH-13644 NISAN	169478	CH12-12251 MNTO	17791-22000-7	ST-14343 TYTA	185578	CH-13818 MNTO
160170-AS	CH-12262 WHITE	16546-25004	CH10-11308 NISAN	169479	CH10-12224 MNTO	178 429.1	ST-13530 CLAS	1863008	CH-14722 DFDS
1602	CH-12385 AMPT	16546-86017	CH14-12245 NISAN	169481	CH-12231 MNTO	17801-1090	SC14-12254 HINO	1863008-1	CH-14722 DFDS
1613 8720 00	CH-17542 ATCO	16546-90204	SC-12274 NISAN	169483	CH-12397 MNTO	17801-1090A	SC14-12254 HINO	1866048-M92	CH08-11288 M-F
1613 9001 00	CH-17541 ATCO	16546-95001	CH12-12251 NISAN	169487	CH-12386 MNTO	17801-1110	CH14-12245 HINO	1866308	CH-14722 DFDS

Number Finder



MFRS. NO.	OUR NO. MFR	MFRS. NO.	OUR NO. MFR	MFRS. NO.	OUR NO. MFR	MFRS. NO.	OUR NO. MFR	MFRS. NO.	OUR NO. MFR
1869555	ST-14715 FDFS	1909138	ST-14343 IVCO	1930747	CH14-12245 IVCO	197588	SC-12252 IVCO	1S-1286	CH-13156 CAT
1869555-1	ST-14715 FDFS	1909139	CH06-11038 FALLI	1930748	SC14-12254 FIATH	197-946-146	CH12-12251 H-H	1S-1287	CH-13150 CAT
1-87810067-0	CH10-11308 ISZ	1909139	CH06-11038 IVCO	1930748	SC14-12254 FAGRI	197-946-184	SC12-11391 H-H	1W-0392	CH-12207 CAT
1886670-M1	CH-14237 M-F	1909140	ST-12226 ALLIC	1930751	CH10-11308 FALLI	197-946-185	CH12-11389 H-H	1W-3636	SC21-17075 CAT
1897151-M1	CH-12209 M-F	1909141	CH06-11056 ALLIC	1930752	SC10-11317 FIATH	197946201	CH-16873 M-F	1W-3637	CH21-17070 CAT
1901779	CH-12235 IVCO	1909699	CH-12217 IVCO	1930752	SC10-11317 FAGRI	197946201	CH-16873 PRKN	2 003 726	CH-14722 FDFS
1901780	CH-12277 FALLI	1909957	CH08-11288 FALLI	1930758	CH-12215 FALLI	197-946-201	CH-16873 H-H	2 003 739	ST-14715 FDFS
1901780	CH-12277 IVCO	1909964	ST08-11316 FALLI	1930764	CH06-11880 IVCO	19796201	CH-16873 M-F	2.4249.010.1	CH04-11675 SAME
1901901	CH-12284 IVCO	1911724	SC14-12254 CLARK	1930765	CH08-11935 FALLI	198492	CH05-11106 FORD	2.4249.010.6	CH04-11675 SAME
1901902	CH14-12245 FALLI	1911725	SC12-11391 CLARK	1930783	CH-12794 IVCO	1987430001	CH-12385 BSH	2.4249.040.1	CH06-11295 SAME
1901902	CH14-12245 IVCO	192003	CH04-11675 SIFO	1930784	CH-12798 FAGRI	1987430003	CH12-11389 BSH	2.4249.050.1	CH05-12222 SAME
1901903	CH12-11389 IVCO	1920723.0003	ST-13531 KALMA	1930784	CH-12798 IVCO	1987430004	CH-12235 BSH	2.4249.050.4	ST-12226 SAME
1901925	CH-12235 IVCO	19215-11220	CH04-11675 KUBT	1930786	CH-12790 FAGRI	1987430005	CH14-12245 BSH	2.4249.060.1	CH06-11295 SAME
1902040	CH-14104 IVCO	1930138	CH-14533 NEWH	1930786	CH-12790 IVCO	1987430008	CH-12386 BSH	2.4249.060.8	CH06-11295 SAME
1902048	CH-12242 IVCO	1930174	CH12-11343 FIATH	1930787	CH-14386 FIATH	1987430009	CH05-11106 BSH	2.4249.070.2	ST06-11315 SAME
1902077	CH-12385 IVCO	1930174	CH-13477 FIATH	1930787	CH-14386 FAGRI	1987430010	CH-12248 BSH	2.4249.070.4	ST06-11315 SAME
1902121	CH-12231 IVCO	1930174	CH12-11343 FAGRI	1930787	CH-14386 FALLI	1987430011	SC14-12254 BSH	2.4249.080.1	CH06-11056 SAME
1902127	CH-12386 IVCO	1930174	CH-13477 FAGRI	1930790	SC10-12395 FALLI	1987430012	CH-12242 BSH	2.4249.080.2	ST-12226 SAME
1902128	CH-12248 IVCO	1930174	CH12-11343 FALLI	1930792	CH06-11880 IVCO	1987430014	CH-12247 BSH	2.4249.090.1	CH-12220 SAME
1902129	CH-12278 FALLI	1930174	CH-13477 FALLI	1930795	ST08-11316 FALLI	1987430022	CH-12285 BSH	2.4249.110.1	CH08-12221 SAME
1902129	CH-12278 IVCO	1930174	CH12-11343 NEWH	1930824	CH08-14835 FIATH	1987430024	CH-12225 BSH	2.4249.110.2	CH08-12221 SAME
1902130	ST-13530 IVCO	1930174	CH-13477 NEWH	1930825	ST08-12229 FIATH	1987430028	CH12-12251 BSH	2.4249.130.0	CH08-11288 SAME
1902131	ST-13531 IVCO	1930349	CH-14380 FAGRI	1930825	ST08-12229 FAGRI	1987430030	CH-16873 BSH	2.4249.130.1	CH08-11288 SAME
1902132	ST-13529 IVCO	1930349	CH-14380 NEWH	1930826	CH10-12390 FALLI	1987430034	CH-12246 BSH	2.4249.130.2	ST08-11316 SAME
1902465	CH-12242 IVCO	19303669	CH08-14410 IVCO	1930826	CH10-14455 FALLI	1987430036	CH-12250 BSH	2.4249.130.7	ST08-11316 SAME
1904550	CH-12278 IVCO	1930476	SC12-11391 IVCO	194008	CH-12839 LSTRP	1987430036	CH-16874 BSH	2.4249.130.8	CH08-11288 SAME
1904550L	CH-12278 HALL	1930536	CH-13075 FAGRI	194009	CH-12206 LSTRP	1987430038	CH-12231 BSH	2.4249.130.9	ST08-11316 SAME
1904581	CH-12231 IVCO	1930587	CH07-14865 FAGRI	194010	CH-12177 LSTRP	1987430042	CH-12232 BSH	2.4249.131.0	CH08-11935 SAME
190537	CH-12385 PGSO	1930587	CH07-14074 IVCO	19404-11081	SC-12274 KUBT	1987430044	CH-12236 BSH	2.4249.170.6	CH06-11056 SAME
1905620	ST-13528 IVCO	1930588	ST07-14270 FAGRI	194196145	CH-12232 M-F	1987430050	CH-12660 BSH	2.4249.190.1	CH05-12222 SAME
1905710	CH-13763 IVCO	1930589	CH08-17365 FAGRI	194229	CH-12262 HOUG	1987430052	CH-12264 BSH	2.4249.250.1	CH-12205 SAME
1905983	CH-12825 IVCO	1930589	CH08-14410 IVCO	194273	CH-12262 HOUG	1987430063	CH16-12253 BSH	2.4249.280.1	SC10-11317 SAME
1907553	CH-14107 IVCO	1930590	ST08-14413 FAGRI	19458-8748-0	CH04-15145 KUBT	1987430064	SC12-11391 BSH	2.4249.280.3	CH-12276 SAME
1908233	CH-14387 IVCO	1930591	CH05-14409 FAGRI	195-426	CH05-11106 CMW	1987430066	CH-12282 BSH	2.4249.290.1	CH08-12228 SAME
1908868	CH-14387 IVCO	1930592	ST05-14402 FAGRI	195-427	CH05-11106 CMW	1987430068	CH-11211 BSH	2.4249.310.4	CH08-11935 SAME
1909116	CH08-12228 ALLIC	1930592	ST05-14402 IVCO	195-671	CH05-11106 CMW	1987430071	CH08-11288 BSH	2.4249.340.1	CH-12290 SAME
1909116	CH08-12228 FALLI	1930602	CH-12345 FIATH	195-682	CH05-11106 CMW	1987430072	CH-12289 BSH	2.4249.340.2	ST-14113 SAME
1909116	CH08-12228 IVCO	1930603	CH10-12390 FIATH	195-703	CH09-12244 CMW	1987430075	ST08-11316 BSH	2.4249.360.1	CH12-11389 SAME
1909116	CH08-12228 NEWH	1930603	CH10-14455 FIATH	195-709	CH09-12244 CMW	1987430077	CH-12278 BSH	2.4249.380.1	CH-12798 SAME
1909117	ST08-12229 FALLI	1930603	CH10-12390 IVCO	195-711	CH08-12243 CMW	1987430078	CH-12238 BSH	2.4249.380.2	SC10-12395 SAME
1909128	CH06-11056 ALLIC	1930603	CH10-14455 IVCO	195-735	CH08-11003 CMW	1990248	CH12-11389 CLARK	2.4249.500.1	CH06-11056 SAME
1909128	CH06-11056 IVCO	1930604	CH-14154 FALLI	196676	CH10-11308 CECH	1D-14	CH-12260 OHSK	2.4249.500.2	ST-12226 SAME
1909129	ST-12226 ALLIC	1930726	ST09-12265 FALLI	196677	CH10-11308 CECO	1DX-31	CH12-12251 OHSK	20008157	CH08-11288 BRD
1909131	CH-12235 FALLI	1930728	ST06-11315 FALLI	1966965-C1	CH08-11003 CASEI	1DX-88	CH16-12253 OHSK	20008157	CH08-11288 IVCO
1909132	ST-13529 FALLI	1930729	CH06-11295 FALLI	197.588	CH-12278 PGSO	1H0129620	CH-12272 VAG	20008158	ST08-11316 BRD
1909132	ST-13529 IVCO	1930730	ST06-12048 IVCO	197.589	ST-13528 PGSO	1H0129620	CH-12272 VAG	2000E-6228	CH05-11106 FORD
1909135	SC10-11317 FALLI	1930740	CH-12216 FALLI	197362	CH05-11467 FORD	1N-4864	SC18-17232 CAT	20015933	CH08-11935 BRD
1909136	CH12-11389 ALLIC	1930746	SC12-11391 FAGRI	19746201	CH-16873 M-F	1R-2005	CH14-12245 FMHD	20015934	ST06-12048 BRD
1909138	ST-14343 FALLI	1930747	CH14-12245 FALLI	19750-1139	CH05-11106 SEM	1R-2006	SC14-12254 FMHD	200-230	CH08-12243 LOED

Number Finder



MFRS. NO.	OUR NO. MFR	MFRS. NO.	OUR NO. MFR	MFRS. NO.	OUR NO. MFR	MFRS. NO.	OUR NO. MFR	MFRS. NO.	OUR NO. MFR
200276	ST08-11316 BELL	204631	CH12-11389 CECO	2109069	CH08-11288 GDDN	219517	CH-12235 SCANI	2241034	CH-12232 KHD
200277	CH08-11288 BELL	204632	SC12-11391 CECO	21097	CH12-12251 CLT	2195196470	CH-12235 SCANI	2241036	CH-12980 KHD
200443	CH14-12245 BELL	204635	CH16-12253 CECO	21100	CH10-12224 CLT	21X11983-C	CH08-12243 JDEER	2241038	CH-12980 KHD
200444	SC14-12254 BELL	204636	SC-12252 CECO	211589	CH-16873 SCANI	21X11984-A	CH08-12243 JDEER	2241329	ST-13531 HAMM
200451	ST09-12265 BELL	204638	CH14-12245 CECO	2119	CH12-11389 NAPA	220-099	CH05-11106 LEROI	2241329	ST-13531 KHD
200452	CH09-12244 BELL	204639	SC14-12254 CECO	211A	CH-12839 WIX	220132	CH18-17230 BELL	2243521	ST-16879 KHD
200467	SC12-11391 BELL	204662	CH-12260 CECH	2121270	CH-12232 ZTLM	220133	SC18-17232 BELL	2243946	ST-13527 DEUTZ
200468	CH14-12245 BELL	2047	CH-12208 NAPA	21212708	CH-12232 ZTLM	2208	CH14-12245 NAPA	2243946	ST-13527 KHD
20051	CH05-11106 MIOF	2047874	CH08-12243 YT	212145	CH08-11935 DYNAP	2209	SC14-12254 NAPA	2258	CH18-17230 NAPA
20053	CH12-12251 MIOF	2047B-64G-01	CH05-11106 T-K	2123	CH05-12222 NAPA	220901	CH05-11106 BOTT	2259	SC18-17232 NAPA
20055	CH12-11389 MIOF	2048	CH-13157 NAPA	2133	PF-15684 NAPA	220902	CH08-11003 BOTT	22624805	ST-13530 ZTLM
20060	CH-12232 MIOF	205-01-73570	CH-13473 KOMD	2137030	CH-12397 ZTLM	220903	CH10-11117 BOTT	2271979	CH08-14410 O&K
20061	CH-12385 MIOF	205-01-73750	CH-13473 KOMD	214	PF-14090 AMPT	220905	CH12-11388 BOTT	2271980	ST08-14413 O&K
20063	CH-12248 MIOF	205-18-240	CH08-11288 BLKW	214	PFM-14095 AMPT	220913	CH-12474 BOTT	227456	CH12-11389 FORD
20064	CH-16873 MIOF	205-19-240	ST08-11316 BLKW	2142	CH08-11003 NAPA	220918	CH-13500 BOTT	2276	CH05-11106 NAPA
2008175	CH-12262 GDDN	205242	CH-12262 FWD	2143-003	CH05-11106 VERMR	220947	CH12-11389 BELL	227671	SC12-11391 FORD
2008200	CH-12260 GDDN	205242	CH-12262 RAGO	2150-007	CH08-11003 VERMR	220981	CH08-11288 BOTT	227959	CH07-14865 MNT0
200867-004	CH06-14733 VERMR	205713	CH-12262 FWD	2165029	CH-12397 KHD	220-99	CH05-11106 LEROI	227960	ST07-14270 MNT0
2009590	PF-15677 GDDN	205713	CH-12262 RAGO	2165038	CH-12231 KHD	221046Z38	CH14-12245 P&H	2290	CH-12260 NAPA
200E6228	CH05-11106 FORD	205747	CH12-12251 RAGO	2165039	CH-12231 KHD	221046Z39	SC14-12254 P&H	2292386	SC10-12395 O&K
2010137	CH12-12251 GDDN	205A	CH-12826 GRFR	2165-039	CH-12231 FAUN	221046Z48	CH14-12245 P&H	2292387	CH10-12390 O&K
2010260	CH12-11389 GDDN	2061350	CH-12231 ZTLM	2165041	CH-12242 KHD	221046Z5	CH-12385 P&H	2292387	CH10-14455 O&K
2010262	CH14-12245 GDDN	20613504	CH-12231 ZTLM	2165044	CH-12386 DEUTZ	221046Z6	CH-12242 P&H	2307428	CH08-12243 BLKW
2010504	CH-12260 GDDN	2068B74	CH05-11106 T-K	2165044	CH-12386 KHD	221106	CH10-12224 DROT	2311565	CH-12091 KHD
2010507	CH-12266 GDDN	20-7000615	SC12-11391 WHITE	2165044EZ	CH-12386 KHD	2211565	CH-12091 KHD	2311778	CH05-11106 CLARK
2010508	CH12-11389 GDDN	20-7002172	CH10-11308 WHITE	2165049	CH-12385 KHD	22133	PF-15684 NAPA	2318016	CH05-11106 CLARK
2010509	CH14-12245 GDDN	20-7300768	CH05-11106 WHITE	2165054	CH-12242 KHD	221406	CH05-11467 FORD	2321	CH08-11288 NAPA
2010697	SC14-12254 GDDN	2078240	CH-12386 ZTLM	2165056	CH-12235 KHD	221407	CH05-11467 FORD	2322855	CH-12225 KHD
2010698	SC-12252 GDDN	20782403	CH-12386 ZTLM	2165059	CH-12235 KHD	221409	CH06-14733 FORD	2323855	CH-12225 KHD
2010699	SC12-11391 GDDN	2078241	CH-12980 ZTLM	2165074	CH-12242 KHD	2216260	CH-16873 KHD	2330387307	CH05-11106 YNMR
201-26010	CH-12206 LSTRP	20782411	CH-12980 ZTLM	21685	CH-12269 ASTR	221688	CH05-11467 FORD	2334	CH-12214 NAPA
201415	CH10-11308 WAUS	2078387	CH10-11308 YT	21685	CH-12269 CAT	221688-A	CH05-11467 RAGO	2335	CH-13156 NAPA
20223	CH-13075 SEM	207965	CH06-14733 WAUK	21686	SC-12270 ASTR	22190599	CH-12790 FALLI	2336	CH-13141 NAPA
2022514	CH12-12251 YT	20801-03101	CH10-11308 TCM	2168629	CH-12248 KHD	222421A1	CH08-14410 CASEI	2339812	CH-12091 KHD
2022550	SC10-11317 O&K	20801-03161	CH12-11389 TCM	216917	SC-12270 RAGO	222422A1	ST08-14413 CASEI	2339813	CH-12091 KHD
202551	CH10-11308 O&K	20801-03361	CH06-16050 TCM	216921	CH-12269 RAGO	2225	CH-12273 NAPA	2339823	CH-12225 KHD
20-3004805	CH05-11106 WHITE	20803	SC14-12254 CLT	216A	PF-15680 GRFR	222531	CH12-12251 FORD	2341502	CH08-12243 L-BL
20-3004926	CH05-11106 WHITE	20804	CH14-12245 CLT	21-736-2224	CH-12385 VOLV	2226	SC-12274 NAPA	2342	CH-12272 NAPA
203-01K1130	CH08-11935 KOMD	2083768	SC12-11391 ALLIC	217490	CH05-11106 FORD	22274	CH08-12243 CLT	2352341	CH14-12245 KHD
20301K1290	ST08-11316 KOMD	2083771	CH12-11389 ALLIC	217517	CH-12235 SCANI	223137	CH08-12243 HYST	2352343	SC14-12254 KHD
203183	CH-12262 FWD	208433	CH08-12243 DROT	217A	CH-12213 GRFR	22344	CH08-11003 CLT	235586	CH-12242 SCANI
203946	CH-12249 ATCO	2087029	CH10-12224 L-BL	21886	CH14-12245 ASTR	22345	CH06-11038 CLT	235A	CH05-11106 GRFR
2042	PF-14090 NAPA	2091-B-09G01	CH05-11106 T-K	218989	CH-12385 SCANI	2237	CH12-12251 NAPA	235AF	CH05-11106 GRFR
2042	PFM-14095 NAPA	2091-B-09H06	CH05-11106 T-K	2191-P-10-089	CH-12262 MACK	2238	CH21-17070 NAPA	23612-44790	SC10-11317 TYTA
2045	CH-12210 NAPA	2097035	CH05-11106 ALLIC	2191-P-10-120	CH-12262 MACK	2239	SC21-17075 NAPA	23613-44790	CH10-11308 TYTA
204538	CH14-12245 CECO	2097035	CH05-11106 FALLI	2191-P-10-123	CH12-12251 MACK	2240348	CH-16873 KHD	237395	CH-12209 ALLIC
2046	CH-13150 NAPA	2097407	CH04-11675 ALLIC	2191-P-10-209	CH-12260 MACK	2240880	CH-12242 ZTLM	2378	CH-12207 NAPA
204623	CH10-11308 CECH	210-01095	CH10-11308 KRNG	2191-P-11-779	CH-12268 MACK	22408800	CH-12242 ZTLM	2379161	ST-16880 KHD
204624	SC10-11317 CECO	210-01107	SC10-11317 KRNG	2191-P-17064	CH-12262 MACK	2240890	ST-13527 ZTLM	2379163	ST-16876 KHD

Number Finder



MFRS. NO.	OUR NO. MFR	MFRS. NO.	OUR NO. MFR	MFRS. NO.	OUR NO. MFR	MFRS. NO.	OUR NO. MFR	MFRS. NO.	OUR NO. MFR
238AF	CH12-12251 GRFR	249572	SC10-11317 FORD	2518	CH06-14733 NAPA	26510229	CH08-11288 PRKN	27.820.00	CH-12210 UFI
2394637	ST-13529 KHD	24999	ST06-11109 SMBR	251A	CH14-12245 GRFR	26510230	SC12-11391 PRKN	27.828.00	CH-12231 UFI
239A	CH12-11389 GRFR	249A	CH-12250 GRFR	2522	CH09-12244 NAPA	26510231	CH06-11295 PRKN	27.837.00	CH-12091 UFI
240.00.389	CH14-12245 KLBL	249A	CH-16874 GRFR	252792	SC14-12254 HYST	26510235	CH09-12244 PRKN	27.838.00	CH-16873 UFI
240.00.504	CH-12235 KLBL	2503	CH08-12221 NAPA	253053	CH08-12243 L-BL	26510236	CH-12209 PRKN	27.839.00	CH-12232 UFI
24000505	ST-13529 KLBL	25041591	PF-15683 GMC	25311500	CH04-11675 TRS	26510238	CH14-12245 PRKN	27.857.00	CH-12247 UFI
2403700	CH08-12243 TAYL	25041593	PF-15683 GMC	253290	CH-12210 CECO	26510288	ST08-11316 PRKN	27.862.00	CH-12213 UFI
240737-M91	CH08-12243 M-F	25041956	CH-12385 GMC	253333	CH-12208 CECO	26510289	CH14-12245 PRKN	27.863.00	CH-12660 UFI
2408868	CH-12248 KHD	25041957	CH-12385 GMC	253341	CH-12207 CECO	26510306	CH10-12390 PRKN	27.875.00	CH-12248 UFI
240A	CH-12262 GRFR	25042135	PF-15677 GMC	253565	CH-13150 CECO	26510306	CH10-14455 PRKN	27.879.00	CH09-12244 UFI
24149	CH09-12244 CHRHM	25042136	PF-15677 GMC	2540	CH-12275 NAPA	26510313	SC10-12395 PRKN	27.889.00	CH-12980 UFI
2414950	ST-13530 KHD	2505	CH-12209 NAPA	254521	CH05-11106 FORD	26510337	CH07-14074 PRKN	27.892.00	CH-12276 UFI
24150	ST09-12265 CHRHM	2505-66	ST06-11315 PCLN	2550	CH-12209 NAPA	26510338	ST07-14270 PRKN	27.893.00	CH14-12245 UFI
2415950	ST-13530 DEUTZ	2505-67	CH06-11295 PCLN	257024	CH08-11288 ALLIC	26510342	CH08-17365 PRKN	27.894.00	SC14-12254 UFI
2415950	ST-13530 KHD	2505-90	CH-12231 PCLN	257029	ST08-11316 ALLIC	26510343	ST08-14413 PRKN	27.919.00	CH05-12222 UFI
242292001	CH-13074 SAME	2505-91	CH-12385 PCLN	257045	CH08-12243 H-C	26510353	CH-16928 PRKN	27.922.00	CH-12208 UFI
242495001	CH06-11056 IVCO	2508	CH-12282 NAPA	25722360	CH05-11106 SXB	26510354	CH-16928 PRKN	27.923.00	CH10-11308 UFI
243153	CH05-11106 O&K	2508228	CH-12248 KHD	257881-C91	CH-12262 IHCH	26510362	CH05-14409 PRKN	27.924.00	CH05-11106 UFI
2446R27755	CH09-12244 KBLC	2508238	CH-12248 KHD	257881-C92	CH-12262 IHCH	265119-C91	CH-12262 CASEI	27.926.00	CH-12273 UFI
2446U154S2	SC10-11317 KBLC	25095197	CH-12234 GMC	258522-M91	ST08-11316 M-F	265247	CH-12262 MUIR	27.931.00	CH06-11056 UFI
2446U154S3	CH10-11308 KBLC	25095977	CH-12232 GMC	258541-M91	CH08-11288 M-F	2653	CH06-12258 NAPA	27.932.00	CH08-11288 UFI
2446U185S3	CH14-12245 KBLC	25095987	CH-12289 GMC	259284	CH-12232 HAMM	2656	CH14-13356 NAPA	27.933.00	CH04-11675 UFI
2446U212S2	SC-12252 KBLC	25096141	CH-12278 AC	2595	PF-15677 NAPA	2657	SC14-13357 NAPA	27.935.00	CH12-12251 UFI
2446U244S1	ST-14343 KBLC	25096141	CH-12278 GMC	259921-C91	CH12-12251 IHCH	266786	CH10-11308 IVCO	27.936.00	CH08-12221 UFI
2446U299S2	ST-14343 KBLC	25096178	CH-12225 GMC	259921-C92	CH12-12251 IHCH	266787	CH09-12244 ALLIC	27.944.00	CH-12268 UFI
2451R124-3A	CH08-11288 KBLC	25096184	CH-11020 GMC	259A	CH-12235 GRFR	2679	ST06-11315 NAPA	27.945.00	CH16-12253 UFI
2451U124-3A	CH12-11389 KBLC	25096188	CH-11211 GMC	2600601	CH05-11106 JCB	267953	ST09-12265 ALLIC	27.949.00	ST08-11316 UFI
2451U124-3B	SC12-11391 KBLC	25096224	CH-12213 GMC	2601863	CH-12235 ATLSW	26814	CH-12266 MRPY	27.950.00	CH-12302 UFI
2451U1803A	CH10-11308 KBLC	25096230	CH-12204 GMC	2601874	ST-13529 ATLSW	2699	CH-12262 LOWE	27.964.00	ST08-12229 UFI
2451U180-3B	SC10-11317 KBLC	25096234	CH-12248 GMC	2608	CH-12235 NAPA	27.007.00	CH-12278 UFI	27.965.00	CH08-12228 UFI
2451U206-3	SC10-11317 KBLC	25096238	CH-12235 GMC	2609	ST-13529 NAPA	27.014.00	ST09-12265 UFI	27.966.00	CH-11211 UFI
2451U221-3	CH05-11106 KBLC	25096242	CH-12653 GMC	260A	CH-12209 GRFR	27.024.00	SC-12252 UFI	27.971.00	CH-12263 UFI
24551160	CH-12386 RENA	25096250	CH-12242 GMC	261185	CH-12264 SCANI	27.052.00	CH-12250 UFI	27.989.00	CH-12236 UFI
2460U196-4	SC14-12254 KBLC	25096252	CH-12215 GMC	26120	PF-15683 NAPA	27.052.00	CH-16874 UFI	27.991.00	CH-12266 UFI
246110	CH10-12224 HYST	25096254	CH-12216 GMC	2618	CH-12268 NAPA	27.148.00	CH-14104 UFI	270.0047	CH-12262 HYMC
246918-M91	CH05-11106 M-F	25096276	CH08-12228 GMC	261A	CH-12248 GRFR	27.217.00	CH-15673 UFI	270.0228	CH05-11106 HYMC
246A	CH-12653 GRFR	25096324	CH-12867 GMC	2630	CH-12177 NAPA	27.707.00	CH-11348 UFI	270.7095	CH06-12258 HYMC
2471-9023	CH-12345 DAEW	25096432	PF-14090 GMC	2631	CH06-11056 NAPA	27.723.00	CH-12249 UFI	270.9026	CH12-11389 HYMC
2474-6025	SC12-11391 DAEW	25096432	PFM-14095 GMC	2632	ST-12226 NAPA	27.724.00	CH-12216 UFI	27059900	CH-12231 TALB
2474-9015	CH08-11288 DAEW	25096464	CH-12247 GMC	2645	CH04-11675 NAPA	27.748.00	CH-12215 UFI	2710	CH-12839 NAPA
2474-9019	SC10-11317 DAEW	250C110-S	CH-12209 UAC	265004	CH-12386 BITEL	27.764.00	CH-12209 UFI	272744	ST-13410 FORD
2474-9020	CH10-11308 DAEW	250C118-S	CH-12209 UAC	265005	ST-13530 BITEL	27.793.00	CH12-11389 UFI	272A	CH-12386 GRFR
2478463	CH04-11675 ADV	250C131-S	CH14-13356 UAC	26510143	CH05-11106 PRKN	27.801.00	CH-12397 UFI	273572-M91	CH09-12244 M-F
247A	CH08-11288 GRFR	250C152	ST08-11110 UAC	26510154	CH12-11389 PRKN	27.802.00	CH-12385 UFI	273743-M91	ST09-12265 M-F
247AF	CH08-11288 GRFR	250C5-S	CH-12209 UAC	26510192	CH05-11106 PRKN	27.803.00	CH-12212 UFI	27516	CH-12135 GLDI
24811/2	ST09-12265 PRKN	250C65-S	CH-12209 UAC	26510208	CH10-11308 PRKN	27.804.00	CH-12386 UFI	2754234	CH08-11003 LUGL
248124A1	PF-16185 MCO	250D27-S	SC14-13357 UAC	26510211	CH08-11003 PRKN	27.805.00	CH-12242 UFI	2754235	CH-13349 LUGL
2489	CH05-11467 NAPA	250D29-S	CH-12268 UAC	26510214	CH08-11288 PRKN	27.806.00	CH-12235 UFI	2764	CH-12262 NAPA
249571	CH10-11308 FORD	251429	CH12-12251 W&S	26510228	ST08-11316 PRKN	27.808.00	CH-12206 UFI	276766	CH14-12245 FORD

Number Finder



MFRS. NO.	OUR NO. MFR	MFRS. NO.	OUR NO. MFR	MFRS. NO.	OUR NO. MFR	MFRS. NO.	OUR NO. MFR	MFRS. NO.	OUR NO. MFR
276767	SC14-12254 FORD	2914 5005 00	SC10-11317 ATCO	2992216	CH14-12245 YT	3039681	CH12-12251 ALLIC	310817	SC-12252 SCANI
2769	ST-14343 NAPA	2914 5017 00	CH-16971 ATCO	299286	CH-12262 CECO	3039972-R1	SC-12252 CASEI	310A	ST06-11109 GRFR
27-7100	CH05-11106 TORO	2914 5018 00	ST-16972 ATCO	299353	CH12-12251 CECO	303A	CH-12249 GRFR	311.00.19.001 ⁴	ST-16488 SDP
27-7110	CH05-11106 TORO	2914 5044 00	CH10-11308 ATCO	299354	CH-12262 CECO	303AT	CH-12249 GRFR	3110019019	ST-16488 SDP
278	CH-12262 AMPT	2914.5000.00	CH14-12245 ATCO	299418	CH12-11389 CECO	304	CH-13150 AMPT	31130-01312	CH10-12224 MTSB
278947	CH-12980 HAMM	2914.5004.00	CH10-11308 ATCO	299A	CH-11211 GRFR	30-4127	CH-12262 DART	31130-02300	CH10-12224 MTSB
28.908.00	CH-11348 UFI	2914182	CH-12248 KHD	2MD-2133	CH12-12251 MACK	30-4217	CH-12262 DART	31130-02900	CH10-11308 MTSB
28-020	CH14-12245 STGR	2914182EE01 ⁴	CH-12248 KHD	2MD-2159	CH-12268 MACK	3042922	CH12-11389 ALLIC	31130-16400	CH12-11389 MTSB
28-021	SC14-12254 STGR	2914-5010-00	CH-16294 ATCO	2MD-3156	CH-12268 MACK	304334	CH-12260 KW	3115559-R91	ST08-12229 CASEI
28040299	CH-12385 TBRG	2914533	SC14-12254 BRYT	2MD-3156-P1	CH-12268 MACK	30-4401	CH-12260 KW	3115560-R2	ST06-12048 CASEI
2811	CH-12206 NAPA	2914534	CH14-12245 BRYT	2MD-352	CH-12262 MACK	3044162	CH10-12224 IVCO	3115560-R91	CH08-12228 CASEI
2811070	CH05-11106 AVBA	2918	CH-14104 NAPA	2MD-354	CH-12262 MACK	3045583	CH10-12224 IVCO	3115569-R2	ST06-12048 CASEI
2811070	CH05-11106 F-A	2919	CH10-11308 NAPA	2MD4122	CH-12268 MACK	3045860	CH12-12251 ALLIC	31230-02112	CH10-11308 MTSB
28130-44000	CH04-11675 HYUN	291A	CH-12660 GRFR	2MD-433	CH12-12251 MACK	3046858	CH08-11003 IVCO	31230-02900	CH10-11308 MTSB
2813-P	CH08-12243 P-M	2920	SC10-11317 NAPA	2P-8863	CH-12214 CAT	3047497	CH12-12251 ALLIC	31230-12700	CH14-12245 MTSB
281A	CH-12246 GRFR	2921	SC10-12395 NAPA	2S1285	CH-13157 NW	3047497-7	CH12-12251 ALLIC	31230-80500	SC14-12254 MTSB
282461-3	CH05-11106 CLARK	29234-527	CH06-14733 MORB	2S-1285	CH-13157 CAT	304880	CH12-11389 KOMD	31230-84800	CH14-12245 MTSB
282A	CH-12236 GRFR	292364	CH-12839 LSTRP	2S1286	CH-13156 NW	304883	SC12-11391 KOMD	3124011-R1	CH08-12228 CASEI
284054	CH08-11288 GETMA	2924	SC12-11391 NAPA	2S-1286	CH-13156 CAT	304A	CH-12289 GRFR	3124011-R2	CH08-12228 CASEI
284055	ST08-11316 GETMA	2927	CH-12269 NAPA	2S1287	CH-13150 NW	305	CH-12210 AMPT	3124012-R1	ST08-12229 CASEI
28442	CH10-11308 ASTR	292737	CH05-11106 AVCO	2S-1287	CH-13150 CAT	3050258	CH12-11389 ALLIC	3125253-R1	ST06-12048 CASEI
285016A1	ST06-11109 CASEI	2928	SC-12270 NAPA	2S-3087	CH-12208 CAT	3050899	CH12-12251 ALLIC	3126100-R1	ST-13530 CASEI
285L	CH-12809 HGST	29294	CH08-12243 HAGE	30.851.00	PF-15684 UFI	3051818	CH12-12251 ALLIC	31-2755007	CH09-12244 WHITE
2868	CH08-11288 NAPA	29321-022	ST08-11110 MORB	30000440155	CH06-11295 ALLIC	305-913-1021	CH05-11106 KOMD	31-2755017	ST09-12265 WHITE
2868515-M1	CH-12232 M-F	29321-211	SC-12252 MORB	300136922	CH12-11389 IVCO	30630-56800	CH05-11106 MTSB	31-2755067	CH10-11308 WHITE
287	CH-12209 AMPT	29321-212	CH16-12253 MORB	300137988	CH-12790 LVRDA	30633	CH-12262 ERF	31-2755077	SC10-11317 WHITE
2874126-M1	CH12-12251 M-F	29321-218	ST08-11316 MORB	300138019	CH-12798 FALLI	3066498-R91	CH05-11106 CASEI	31-2755087	CH10-11308 WHITE
2874154-M1	CH12-11389 M-F	29321-219	CH08-11288 MORB	30030-83100	SC12-11391 MTSB	3067508	ST08-11316 ALLIC	31-2990561	CH08-12228 WHITE
2874165-M1	CH-16873 M-F	29321-255	CH18-17230 MORB	30030-84100	CH10-11308 MTSB	306909-C91	CH12-12251 IHCH	3135188-R1	ST08-11316 CASEI
2874186-M1	SC12-11391 M-F	29321-256	SC18-17232 MORB	30030-84200	SC10-11317 MTSB	3072893-M1	CH08-11288 M-F	313964-R91	CH-12209 CASEI
2878	CH-12249 NAPA	294	CH-12208 AMPT	30049	CH06-14733 MACK	3074304-M1	CH-12286 M-F	313AF	CH06-12258 GRFR
2879154-M1	CH12-11389 M-F	295	CH-13157 AMPT	300-5-214-02	CH12-11389 PEARL	3074305-M1	CH-12276 M-F	3146576-R1	CH-12231 CASEI
287A	CH-12242 GRFR	295 043 76	CH-12385 DEMG	3013206	CH16-12253 CECO	3074307-M1	ST09-12265 M-F	3146939-R1	CH-12386 CASEI
288	CH12-12251 AMPT	29504356	CH-12235 DEMG	3013207	SC-12252 CECO	3074308-M1	SC10-11317 M-F	3147878-R1	ST-16487 CASEI
288A	CH-12385 GRFR	29504476	CH-12285 DEMG	3013208	CH14-12245 CECO	30-8016	CH-12262 SCRD	3147878R2	ST-16487 CASEI
2890	CH-12262 NAPA	2951-H2-4	CH-12262 WHITE	3013209	SC14-12254 CECO	30-8047	CH-12262 SCRD	3148080-R1	ST-16488 CASEI
28918-005	SC-12274 VERMR	296	CH-12207 AMPT	3013212	CH18-17230 CECO	30924	CH-12273 VERS	3153187-R1	CH08-11288 CASEI
28918-0051	SC-12274 VERMR	2966	CH-12268 NAPA	3013213	SC18-17232 CECO	30927	SC-12274 VERS	3153188-R1	ST08-11316 CASEI
28918009	CH-12273 VERMR	297A	CH-12264 GRFR	302 AIR	PF-14090 DX	309441	CH-12264 SCANI	3154700-R1	CH10-11308 CASEI
289185	CH-12206 LSTRP	298	CH-12214 AMPT	302 AIR	PFM-14095 DX	3095082M1	PF-15679 H-H	3154701-R1	SC10-11317 CASEI
2900 0593 00	CH-12285 ATCO	298 1113	CH08-14410 ATLAS	30-2012251	CH12-11389 WHITE	3096340M91	CH-12286 H-H	317042	CH-12262 CLARK
2900 5348 00	CH08-11288 ATCO	29800164	CH-13824 HEDEN	30-2012324	SC12-11391 WHITE	30981-70110	CH08-11288 KWSK	3173081800	CH08-11288 KBLC
2900 6488 00	CH05-11106 ATCO	2981124	ST08-14413 ATLAS	30257	CH12-11389 ASTR	309967-C91	CH-12262 IHCH	3178080-R1	ST-16488 CASEI
2900-0206	CH-12278 ATCO	2985037	ST-13530 KHD	302597	ST05-14980 POWB	31020/003	ST08-11110 MTBR	318244/2	CH10-12224 AVBA
2900-0501 00	ST-13527 ATCO	298A	CH-12213 GRFR	302842	CH05-11106 POWB	3107368-H2	CH12-11389 DMNDT	3182-C-44G01	CH05-11106 T-K
2900052500	ST-13529 ATCO	2990511	CH-12262 YT	303	CH-13156 AMPT	3107368-H2	CH12-11389 WHITE	31930-35100	CH12-12251 MTSB
291 1788	CH05-14409 ATLAS	2991489	CH12-12251 YT	303048581	CH08-11003 IVCO	310813	CH14-12245 SCANI	319700-P01	CH05-11106 HAGE
2912005	CH-12386 KHD	2991546	CH07-14074 ATLAS	30-3070342	CH10-11308 WHITE	310814	SC14-12254 SCANI	319700-PO	CH05-11106 HAGE
2912007	CH-12248 KHD	2991764	CH12-11389 YT	30-3070352	CH10-11308 WHITE	310816	CH16-12253 SCANI	319709-P01	CH05-11106 HAGE

Number Finder



MFRS. NO.	OUR NO. MFR	MFRS. NO.	OUR NO. MFR	MFRS. NO.	OUR NO. MFR	MFRS. NO.	OUR NO. MFR	MFRS. NO.	OUR NO. MFR
31X10894-A	CH05-11106 JDEER	3226416-R1	CH-12385 CASEI	339A	CH-12857 GRFR	35109263	CH16-12253 I-R	366-08109	CH07-14865 LSTRP
32/201601	SC12-11391 JCB	3230272	CH12-11389 CECO	340	CH08-12221 AMPT	35109271	SC-12252 I-R	36608110	ST07-14270 LSTRP
32/201602	CH12-11389 JCB	3230273	SC12-11391 CECO	340.00.091	CH10-11308 KLBL	351133	CH-12262 KRSH	366379-C91	CH12-12251 IHCH
32/202501	SC12-11391 JCB	323272-C91	CH12-12251 IHCH	340.00.191	ST-13527 KLBL	35176	CH05-11106 ERKS	368016	ST-13529 SCANI
32/202601	ST08-11316 JCB	323273-C91	CH12-12251 IHCH	340.00.291	CH12-12251 KLBL	35178	CH05-11106 ERKS	36876423	CH06-14733 I-R
32/202602	CH08-11288 JCB	3236A	CH-12213 BSH	340.00.320	CH12-11389 KLBL	351A	CH04-11675 GRFR	370754	CH-12264 SCANI
32/203702	CH06-12258 JCB	324795-R91	CH-12262 IHCH	340.00.330	SC14-12254 KLBL	351AF	CH04-11675 GRFR	373376	CH08-11288 FORD
32/206002	CH06-11941 JCB	3252001-M1	ST-16488 M-F	340.00.460	CH-12242 KLBL	352	CH04-11675 AMPT	375272	ST09-12265 FORD
32/903001	CH-13185 JCB	326483	CH05-11106 HYST	340.00.489	CH-12385 KLBL	352-43820	CH-12177 LSTRP	375273	CH09-12244 FORD
32/903601	CH-13270 JCB	327A	ST08-11316 GRFR	340.00.490	ST-13531 KLBL	35274745	SC-12270 I-R	3760947104	CH10-11308 DMBZ
32/905002	ST-14787 JCB	328181	CH08-12243 WAGN	340.00.594	CH10-12224 KLBL	35274752	CH-12269 I-R	376826	ST08-11316 FORD
32/912901	CH-16928 JCB	3281825-M1	CH04-11675 M-F	3401261	CH08-12243 CHRYS	35275965	SC-12274 I-R	377055	CH06-11295 FORD
32/912902	ST10-15380 JCB	328185	CH08-12243 WAGN	3401368	CH08-12243 CHRYS	35275973	CH-12273 I-R	377059	ST06-11315 FORD
320	CH05-11106 AMPT	3282011-R91	CH-12260 CASEI	3405458-R1	CH-12386 CASEI	35291509	CH05-11467 I-R	37H2004	CH-12653 LEYL
320002.0	ST08-11110 CLAS	328A	CH-12231 GRFR	341	CH-12275 AMPT	35291970	CH06-14733 I-R	37H3739	CH08-11288 LEYL
320498850	ST08-11316 IVCO	3291210-R1	CH08-11288 CASEI	341021-11120	SC12-11391 MTSB	35298108	CH18-17230 I-R	37H4920	CH-12209 LEYL
320651750	CH-12794 LVRDA	32-913602	ST06-12048 JCB	341021-11140	CH12-11389 MTSB	35298116	SC18-17232 I-R	37Z-02-AF931	CH05-11106 KOMD
3210185-R1	CH12-11389 CASEI	329A	CH10-11308 GRFR	3429703	PF-14910 CECO	35318252	CH08-11288 I-R	37Z-02-AF9311	CH05-11106 KOMD
3214300200	CH04-11675 HTCH	329AF	CH10-11308 GRFR	3438717-M1	ST-14343 M-F	35326230	CH09-12244 I-R	37Z-02-AF932	CH04-11675 KOMD
3214300200	CH04-11675 HOKY	3310354-M1	ST06-12048 M-F	344094710494	CH-12232 DMBZ	35508	CH05-11106 ERKS	37Z-02-AF9321	CH04-11675 KOMD
3214300300	SC-12274 HOKY	3310355-M1	CH08-11935 M-F	344094730494	ST-13531 DMBZ	35516458	CH14-12245 LEYL	380347-R91	CH05-11106 IHCH
3214300600	CH12-12251 HOKY	3310357	ST06-12048 LNDI	3441	PF-15684 FCET	355607-C1	CH14-12245 CASEI	380347-R92	CH05-11106 IHCH
3214300900	CH12-12251 HOKY	3310357-M1	ST06-12048 M-F	344A	CH-12867 GRFR	355994	CH-12213 VOLV	381343-R91	CH05-11106 CASEI
3214302200	SC-12274 HOKY	3310358	CH06-11880 LNDI	34530-01030	SC-12274 MTSB	3570821	CH-12500 VCE	381-976326-1	CH12-11389 KOMD
3214302600	SC-12274 HOKY	3310358-M1	CH06-11880 M-F	34530-02300	SC-12274 MTSB	3570822	CH-12279 VCE	382-07903	CH-13404 LSTRP
3214302700	CH12-11389 HOKY	3314-H2	CH12-12251 WHITE	34530-02300E	SC-12274 MTSB	3575	PF-15683 FCET	38610107	CH04-11675 MTSB
3214303600	CH14-12245 HOKY	3315187	CH12-11389 CECO	346396	CH14-12245 WAGN	3576571	CH08-11935 VOLV	388021-11210	CH-16689 FKWA
32143-04100	CH12-11389 MTSB	3318279	CH05-11106 CECO	346397	SC14-12254 WAGN	35767	CH05-11106 ERKS	388021-11220	SC-16290 FKWA
32143-05300	SC14-12254 MTSB	33242237	CH12-12251 L-BL	346398	CH14-12245 WAGN	3580723M1	CH-12794 M-F	388126-R1	CH05-11106 IHCH
3214305900	CH04-11675 HTCH	3325106	CH09-12244 CHMPI	346399	SC14-12254 WAGN	35902295	CH08-12243 I-R	388126-R91	CH05-11106 IHCH
32143-06500	SC12-11391 MTSB	3325291	SC14-12254 CECO	346-700-1504C	SC10-11317 TDANO	359519-M1	ST06-12048 M-F	389263-R91	CH08-12243 CASEI
32143-06800	CH10-11308 MTSB	3325292	CH14-12245 CECO	346-700-1505C	CH10-11308 TDANO	35A255106	CH-12234 MAN	389290-R91	CH05-11106 IHCH
321549250	SC14-12254 IVCO	333494	CH05-11106 CLARK	347138	CH-12826 VOLV	35A-8197	CH05-11106 WHITE	389567-R91	CH05-11106 CASEI
3216 2614 00	SC12-11391 ATCO	3341-H2	CH12-12251 WHITE	3471380	CH-12826 VOLV	35A-8260	CH05-11106 WHITE	390221	CH08-12243 HYST
3216 2771 00	CH-12269 ATCO	3353440	CH-12385 CECO	347436	CH-12213 VOLV	35P-1601	CH05-11106 WHITE	3902806M1	CH-16969 M-F
3216 2772 00	SC10-11317 ATCO	335494	CH05-11106 CLARK	347437	CH-12660 VOLV	360224	CH-12250 VOLV	3902812M1	ST-16970 M-F
3216 3286 00	CH14-12245 ATCO	335498	CH05-11106 CLARK	347686	CH08-12243 WAGN	360224	CH-16874 VOLV	3905241	CH08-12243 CECO
3216 3287 00	SC14-12254 ATCO	33664	CH12-11389 ERF	347A	CH-12247 GRFR	360628320	SC-12252 JOY	39125547	CH-12847 I-R
3216 7080 01	CH08-11942 ATCO	3366456	CH-12208 KHD	3493878	CH05-11106 CLARK	360956	CH12-11389 WAGN	39134	CH14-12245 ERF
3216 7082 02	SC10-12395 ATCO	3367A	CH-12250 BSH	349A	ST-13531 GRFR	3621275M1	CH06-14733 M-F	393199	CH-12386 SMBR
3216100-R1	ST-13530 CASEI	3367A	CH-16874 BSH	34A-02-34130	CH04-11675 KOMD	3621282M1	CH08-11288 M-F	393561	CH-14107 DAF
3216100R2	ST-13530 CASEI	3371378-R1	CH09-12244 CASEI	34B-02-31930	CH05-11106 KOMD	3621283M1	ST08-11316 M-F	394 686 40	ST-13530 DEMG
3216-5237-00	CH08-11935 ATCO	3371379-R1	ST09-12265 CASEI	350044AA	CH-12278 PERL	3621284M1	CH06-11941 M-F	395773	CH-12387 SCANI
3216-5238 00	ST08-11316 ATCO	3372006-R1	CH-12276 CASEI	350087A	CH-15673 PERL	362224-8	CH-12385 VCE	395841	CH08-11288 HYST
3219420-R91	CH-12385 CASEI	3375263-R1	SC12-11391 CASEI	350088A	SC-15681 PERL	362264	CH-12250 VOLV	395842	ST08-11316 HYST
3219421-R1	ST-13531 CASEI	3375264-R1	CH12-11389 CASEI	350A	ST-13527 GRFR	362264	CH-16874 VOLV	397079	CH05-11106 LSTRP
321A	CH-12781 GRFR	3385733-M1	CH-14237 M-F	35103217	CH-12847 I-R	3651225M91	PF-15890 LNDI	39708466	CH-12843 I-R
32-208304	SC10-11317 JCB	3388840-M2	PF-15891 M-F	35109156	CH14-12245 I-R	365729	CH-12264 SCANI	397305	CH04-11675 LSTRP
3222-1881-91	CH-16294 ATCO	3389792-M2	CH-12794 M-F	35109206	SC14-12254 I-R	36608105	CH05-14409 LSTRP	3C0183	CH-12209 CAT

Number Finder



MFRS. NO.	OUR NO. MFR	MFRS. NO.	OUR NO. MFR	MFRS. NO.	OUR NO. MFR	MFRS. NO.	OUR NO. MFR	MFRS. NO.	OUR NO. MFR
3C0183E	CH-12209 CAT	4025933	CH10-12224 IVCO	413042	CH-12235 DONIT	4203523	CH-12262 KRNG	42480759	ST-13527 ALLIC
3EA-01-12130	CH-12770 KOMD	403	CH12-11389 AMPT	413082	CH-12386 DONIT	4203568	CH08-12243 KRNG	42480759	ST-13527 IVCO
3EA-01-16120	CH04-11675 KOMD	403217	CH05-11106 H-W	413086	CH-12091 DONIT	420356-A	CH-12260 KRNG	42481020	ST-13529 IVCO
3EA-01-18130	CH-12770 KOMD	4033109540	CH-12980 RENA	413090	CH16-12253 DONIT	4203572	CH12-12251 KRNG	42481021	ST-13529 IVCO
3EA-01-18130I	CH-12770 KOMD	4035541	CH-12266 WBCO	413095	CH-12234 DONIT	42035886	ST07-14270 MUST	42484344	CH08-11288 IVCO
3EB-01-25380	CH-12716 KOMD	403756	CH12-12251 TJK	413095B	CH-12242 DONIT	42042	PF-14090 WIX	42484726	CH12-11389 IVCO
3EB-02-25550	ST-14343 KOMD	403997	CH08-12243 HBRT	413098	CH-12385 DONIT	42042	PFM-14095 WIX	42488361	CH-12278 IVCO
3EC-01-25830	CH-12716 KMTS	404	CH14-12245 AMPT	4134-352	CH10-11308 FAUN	42045	CH-12210 WIX	42489	CH05-11467 WIX
3H-218	CH12-12251 L-BL	4044300	CH08-11003 TAYL	4134-366	CH-12385 FAUN	42046	CH-13150 WIX	425002-R91	CH-12262 IHCH
3I0105	SC21-17075 CAT	405	SC14-12254 AMPT	4134-367	ST-13531 FAUN	42047	CH-12208 WIX	42503	CH08-12221 WIX
3I0126	SC14-12254 CAT	4055125	CH-12262 IVCO	4134-368	CH-12386 FAUN	42048	CH-13157 WIX	42505	CH-12209 WIX
3I0167	ST-14343 CAT	4055126	CH-12262 IVCO	4134-370	ST-13530 FAUN	4206272	CH18-17230 HTCH	42508	CH-12282 WIX
3I0215	SC18-17232 CAT	4055695	CH-12260 IVCO	4134-389	CH12-11389 FAUN	4206273	CH18-17230 HTCH	42518	CH06-14733 WIX
3I0795	CH18-17230 CAT	4055745	CH-11348 ALLIC	4134-403	CH-12235 FAUN	42119	CH12-11389 WIX	42522	CH09-12244 WIX
3I0799	CH14-12245 CAT	4056630	CH10-12224 IVCO	4134-406	CH-12242 FAUN	42123	CH05-12222 WIX	42540	CH-12275 WIX
3I0836	CH-12386 CAT	4058189	SC10-11317 EUC	4134-407	ST-13527 FAUN	42133	PF-15684 WIX	42550	CH-12209 WIX
3I0925	CH-12269 CAT	4059252	CH08-11003 IVCO	4134-415	ST-13529 FAUN	4213582	PF-15683 CHRYS	42595	PF-15677 WIX
3I0929	CH05-11106 CAT	4059818	SC12-11391 HTCH	4134-419	ST-13528 FAUN	4213583	PF-15684 CHRYS	42608	CH-12235 WIX
3I-2147	CH05-15887 CAT	406.00.261	SC14-12254 KLBL	4134-428	ST-16488 FAUN	42142	CH08-11003 WIX	42609	ST-13529 WIX
3N-3740	CH-12260 CAT	4080065	SC10-11317 HTCH	4134-474	CH-12232 FAUN	42208	CH14-12245 WIX	42618	CH-12268 WIX
3R-7714	CH-12260 CAT	4080066	CH10-11308 HTCH	4137604	CH08-11288 HTCH	42209	SC14-12254 WIX	42630	CH-12177 WIX
4.581135.3	CH14-12245 UNID	4085787	CH14-12245 HTCH	41448896	ST-16488 KHD	42225	CH-12273 WIX	42631	CH06-11056 WIX
4.581576.3	CH16-12253 UNID	4085788	SC14-12254 HTCH	4144896	ST-16488 KHD	42226	SC-12274 WIX	42632	ST-12226 WIX
4.581641.2	SC14-12254 UNID	4090408	CH12-11389 HTCH	4144966	ST-13529 KHD	42231410300	PF-15857 STIHL	42645	CH04-11675 WIX
4.582229.8	SC-12252 UNID	4090409	SC12-11391 HTCH	4146001	CH-11348 ALLIC	42237	CH12-12251 WIX	42653	CH06-12258 WIX
40000614	CH08-12243 HERC	40A-134	CH05-11106 WHITE	4146898	CH14-12245 HTCH	42238	CH21-17070 WIX	42656	CH14-13356 WIX
4001135	CH-12269 EUC	4100-021	CH04-11675 HY-M	4149014	CH10-11308 KHD	42239	SC21-17075 WIX	42657	SC14-13357 WIX
4001155	SC-12270 EUC	41007448	CH12-11389 LEYL	4149022	SC10-11317 KHD	42258	CH18-17230 WIX	42668	CH14-12245 SULL
4001156	CH-12269 EUC	4100806	CH12-11389 HTCH	4149908	CH06-11295 CLARK	42259	SC18-17232 WIX	42668-1	CH14-12245 SULL
4001363	CH08-12243 ARMAN	41008819	CH14-12245 LEYL	415039	CH09-12244 TJK	42263	CH10-12224 SULL	42679	ST06-11315 WIX
4003012-R1	CH-12266 CASEI	41017302	CH14-12245 LEYL	415040	ST09-12265 TJK	42268-1	CH14-12245 SULL	42710	CH-12839 WIX
4003987	SC-12274 EUC	4108-311	CH05-11106 HY-M	4155107	ST-13527 CLARK	4227087	PF-15683 CHRYS	427334	SC-12270 CAT
400590	SC-12274 KOMD	411.85.19.0010	CH-12231 SDP	416505-50810	CH-14237 YNMR	42276	CH05-11106 WIX	42764	CH-12262 WIX
400594	SC-12270 KOMD	41120	SC-12274 SULL	41735724	CH12-11389 LEYL	42290	CH-12260 WIX	42769	ST-14343 WIX
4012356	CH-12266 EUC	41130007A	CH10-11308 MVM	418-01-K1170	SC12-11391 KMTS	42321	CH08-11288 WIX	427753-R91	CH-12262 IHCH
4012358	SC-12270 EUC	41130008A	CH06-11295 MVM	41X10894-A	CH05-11106 JDEER	42334	CH-12214 WIX	4278774	CH-12235 DEMG
4012359	CH-12269 EUC	4113006	CH08-11288 MVM	42011410300	CH-12953 STIHL	42335	CH-13156 WIX	42811	CH-12206 WIX
4012360	SC-12274 EUC	4113007	CH10-11308 MVM	42011410303	CH-12953 STIHL	42336	CH-13141 WIX	42868	CH08-11288 WIX
40123606	SC-12274 VOLV	4113008	CH06-11295 MVM	42015789	CH-12235 FALLI	42342	CH-12272 WIX	42878	CH-12249 WIX
4012361	CH-12273 EUC	4113009	ST06-11315 MVM	420-1815	CH05-11106 OWAT	423448-R91	CH-12262 CASEI	42890	CH-12262 WIX
4015860	CH-12260 EUC	4113026	ST08-11316 MVM	42018158	CH05-11106 OWAT	4237633	CH14-12245 HTCH	4290940	CH06-16050 FIATH
40199	CH-12345 BNFR	4113027	SC10-11317 MVM	420-18567	CH05-11106 OWAT	4237663	CH14-12245 HTCH	42918	CH-14104 WIX
402	SC12-11391 AMPT	41132011A	CH08-11288 MVM	420-1923	CH05-11106 OWAT	42378	CH-12207 WIX	42919	CH10-11308 WIX
4021443	CH08-12243 FALLI	41132013A	SC10-11317 MVM	42019238	CH05-11106 OWAT	423841	CH09-12244 ATLSW	42920	SC10-11317 WIX
402219502	CH-12385 LHNHS	4113705	CH14-12245 MVM	420-2127	CH05-11106 OWAT	42391/1	CH12-11389 FDN	42921	SC10-12395 WIX
402219505	ST-13531 LHNHS	41185190007	ST-16487 SDP	420-31932	CH04-11675 OWAT	42391/1	CH12-11389 S-A	42924	SC12-11391 WIX
402-3152-300	CH12-11389 KUBT	4122937	CH14-12245 HTCH	4203293	CH-12262 KRNG	4241042	PF-15684 CHRYS	42927	CH-12269 WIX
402-5156-400	SC-12274 KUBT	4130115U	CH10-11308 DONIT	420-34599	CH05-11467 MUST	4244607	SC12-11391 HTCH	42928	SC-12270 WIX
402-5156-500	SC12-11391 KUBT	413033	CH-11348 DONIT	4203509	CH-12262 KRNG	424580	CH09-12244 ATLSW	4294845	CH-12739 HTCH

Number Finder



MFRS. NO.	OUR NO. MFR	MFRS. NO.	OUR NO. MFR	MFRS. NO.	OUR NO. MFR	MFRS. NO.	OUR NO. MFR	MFRS. NO.	OUR NO. MFR
4294846	CH-12770 HTCH	4505514	ST-14343 NEUS	46-0961	CH-12262 SCRDR	46502	CH-14722 WIX	475190	CH12-11389 VOLV
42966	CH-12268 WIX	450613	CH-12266 WDSC	46120	PF-15683 WIX	46504	CH-14334 WIX	475191	SC12-11391 VOLV
4306113	PF-15683 CHRYS	450879-C1	CH-12268 CASEI	461249-C1	CH12-11389 CASEI	46510	CH-12225 WIX	475220	CH-12250 VOLV
4306113	PF-15683 GMC	4510054134	CH-13835 M&H	46-1253	CH12-12251 SCRDR	46515	CH-12386 WIX	475220	CH-16874 VOLV
4308634	ST-16880 KHD	4511455209	ST-16488 M&H	46133	PF-15684 WIX	46517	ST-13410 WIX	475230	CH-12250 VOLV
4308636	ST-16876 KHD	45141	CH-12273 SULL	46134465	CH12-12251 BUCYE	46522	ST08-11316 WIX	475230	CH-16874 VOLV
431	CH10-11308 AMPT	45142	SC-12274 SULL	46140232	CH10-12224 BUCYE	465249-C1	CH12-11389 CASEI	475338	CH-12213 VOLV
431181	ST09-12265 ATLSW	4516555224	CH-12231 M&H	46140235	CH12-12251 BUCYE	46525	ST-13531 WIX	475339	CH-12660 VOLV
431455	CH08-11935 PANH	4516555239	ST-16487 M&H	46140236	CH12-12251 BUCYE	46526	CH06-11941 WIX	475386	CH-12283 VOLV
4319256	ST08-12229 KHD	451867	CH-12276 ATLSW	46140306	CH-12282 BUCYE	46532	ST-13530 WIX	475599	CH-12262 WBCO
431-9257	CH08-12228 KHD	45-213	CH-12269 STGR	46140340	CH-12260 BUCYE	46534	CH-12867 WIX	475618	CH-12250 VOLV
4319262	SC10-11317 KHD	45-213S1	CH-12269 STGR	46143960	CH-12262 BUCYE	46537	CH08-12228 WIX	475618	CH-16874 VOLV
4319263	CH-12276 KHD	4522555229	ST-13530 M&H	461470	CH-12262 PCF	46538	ST08-12229 WIX	475755	CH-11211 VOLV
432	SC10-12395 AMPT	4522592304	CH-12386 M&H	46-1470	CH-12262 SCRDR	46541	CH-12242 WIX	4758610	CH-12386 VOLV
4326841	ST06-16054 HTCH	45-252	CH-12266 STGR	46149231	CH10-12224 BUCYE	46546	CH-12232 WIX	475975	CH-12289 VOLV
43327/1	CH12-12251 S-A	452529	CH-12794 FORD	46151725	CH12-12251 BUCYE	46547	CH-12283 WIX	475975-9	CH-12289 VOLV
4337639	SC14-12254 HTCH	45-252S1	CH-12266 STGR	46163290	CH-12282 BUCYE	46554	CH-12385 WIX	476769	CH-12213 VOLV
43-422	CH08-12243 LEROI	45305277	PF-15858 CARA	46163360	CH10-12224 BUCYE	46560	ST09-12265 WIX	476769-5	CH-12213 VOLV
43-422-1	CH08-12243 LEROI	45305278	PF-15859 CARA	46188	CH-12206 WIX	46561	CH-12286 WIX	477 AIR	SC12-11391 DX
4342800	PF-15684 CHRYS	45305574	PF-15860 CARA	46210	CH-12847 WIX	46562	ST08-12229 WIX	4771477	PF-15686 VOLV
4342801	PF-15683 CHRYS	45305768	PF-15866 CARA	462252	CH-12260 PCF	46569	ST08-14413 WIX	4771477-9	PF-15686 VOLV
43-493	CH05-11106 LEROI	4532592304	CH-12385 M&H	46-2252	CH-12260 SCRDR	46580	PF-14090 WIX	477220-12810	CH12-11389 MTSB
43-493-1	CH05-11106 LEROI	45401	CH-10677 AGRI	46263	ST05-14980 WIX	46580	PFM-14095 WIX	47805	PF-15861 AGRI
4357487	CH-12262 ALLIC	45401	CH-10677 CRRO	46270	CH04-11675 WIX	46594	CH-12234 WIX	4780961	CH-12385 VOLV
4357688	CH-12262 ALLIC	45409	CH08-11003 AGRI	46274	CH-12215 WIX	46606	CH06-11295 WIX	478463	CH04-11675 ADV
4358792	CH-12262 ALLIC	45409	CH08-11003 CRRO	46294	CH-12091 WIX	46613	CH-13270 WIX	4785610	CH-12386 VOLV
43-635	CH05-11106 LEROI	4544092304	CH-12242 M&H	463009	ST08-11316 ATLSW	46625	CH08-11942 WIX	4785610-9	CH-12386 VOLV
43-635-1	CH05-11106 LEROI	4544092664	CH-12242 M&H	4631072	CH-12385 SAUR	46642	CH-12276 WIX	4785611	ST-13530 VOLV
43-646	CH12-12251 LEROI	45449	SC06-11269 AGRI	4631072000	CH-12242 SAUR	46643	SC10-11317 WIX	4785611-7	ST-13530 VOLV
4384102	CH-12091 KHD	45449	SC06-11269 CRRO	4631072010	CH-16873 SAUR	46652	CH07-14074 WIX	4785612	CH-12386 VOLV
4384103	CH-12225 DEUTZ	45450	CH06-11255 AGRI	4631072020	CH-12242 SAUR	466535	CH10-11308 ATLSW	4785746	ST-13527 VOLV
4384103	CH-12225 KHD	45450	CH06-11255 CRRO	46313	CH-12397 WIX	466546	SC10-11317 ATLSW	4785746-1	ST-13527 VOLV
4386484	CH-12262 ALLIC	45452	SC08-11253 AGRI	46327	CH-12272 WIX	46672	ST07-14270 WIX	4785748	CH-12235 VOLV
439203768	CH12-11389 HALL	45452	SC08-11253 CRRO	46328	CH-12247 WIX	46741	CH-12278 WIX	4785748-7	CH-12235 VOLV
440042467	CH10-11308 YT	45453	CH08-11003 AGRI	46330	CH-12285 WIX	46852	CH-12289 WIX	4785749	ST-13529 VOLV
440042468	SC10-11317 YT	45453	CH08-11003 CRRO	46351	CH-12213 WIX	46868	CH-11020 WIX	4785749-5	ST-13529 VOLV
440051973	CH05-11106 YT	45474	CH-12266 ASTR	46352	CH-12403 WIX	462166	CH12-12251 P&H	4785921	SC-12252 VOLV
440052940	CH-12397 YT	45480068	CH-11348 ALLIC	46360	CH05-11106 WIX	47047	CH10-12224 WIX	4785922	CH16-12253 VOLV
440056440	CH08-11288 YT	455044	CH06-11295 MNT0	46375	ST08-11110 WIX	47048	SC-12252 WIX	478720	CH05-11467 ADV
440056441	ST08-11316 YT	4565092304	CH-12235 M&H	46378	CH-12605 WIX	47052	CH16-12253 WIX	478722	ST-13410 ADV
440337	CH14-12245 O&K	45690-001-15	CH08-12243 IOWA	46407	ST-14715 WIX	47210	PF-15888 AGRI	4788592	CH-12387 FALLI
440414002	SC10-11317 SAKAI	45690-001-152	CH08-11003 IOWA	46408	CH-12485 WIX	47220-12012	CH12-11389 MTSB	4789056	CH05-11106 ALLIC
440414003	CH10-11308 SAKAI	45740-70111	CH-12207 MTSB	46414	CH-12248 WIX	47220-12820	SC12-11391 MTSB	4789056	CH05-11106 FALLI
4418	CH-12206 COPR	45740-70210	CH-12214 MTSB	46430	CH-12231 WIX	47220-22810	SC14-12254 MTSB	480 AIR	CH05-11106 DX
44185190010	CH-12231 SDP	45740-70510	CH-12208 MTSB	46466	CH08-12228 WIX	47220-22820	CH14-12245 MTSB	48013048	PF-15862 CARA
44509001	CH05-11467 CARA	458455	CH08-11288 ATLSW	46467	ST08-12229 WIX	47220-24800	CH14-12245 MTSB	4807/2T	CH-12206 COPR
448037	CH08-11288 MNT0	4588092304	CH-12278 M&H	46487	CH08-12228 WIX	474 AIR	CH08-12243 DX	4807T	CH-12206 COPR
44819	CH-12262 SULL	460406	CH-12233 VOLV	46496	CH-12716 WIX	47426/1	CH14-12245 S-A	4808801	CH-12177 ASTM
4505-43	CH-12276 PCLN	460803-C1	CH-12282 CASEI	46498	CH-12491 WIX	475081	CH14-12245 VOLV	4841879	CH05-11106 ALLIC

Number Finder



MFRS. NO.	OUR NO. MFR	MFRS. NO.	OUR NO. MFR	MFRS. NO.	OUR NO. MFR	MFRS. NO.	OUR NO. MFR	MFRS. NO.	OUR NO. MFR
4841879	CH05-11106 FALLI	4930646	CH05-11106 DONIT	50.08304.0003	CH10-11308 MAN	5011323	CH-12213 FDFS	5095818-01	CH-12209 YT
4861641	CH08-12243 FALLI	4930684	CH-12397 DONIT	50.08304.0004	CH09-12244 MAN	5011325	CH-12242 FDFS	510 6181	CH-12235 LBHR
4880631	CH-12276 VOLV	497 AIR	CH-12210 DX	50.08304.0005	CH14-12245 MAN	5011326	CH-12248 FDFS	510 6191	CH-12278 LBHR
4880632	SC10-11317 VOLV	4971958	CH-12203 FIATH	500.414	ST-13527 HTCH	5011327	CH12-12251 FDFS	51021000	CH04-11675 SMBR
4881174	CH-12266 VME	4975549	CH-12203 FIATH	5000 819 025	CH10-12224 RENA	5011328	CH-16873 FDFS	5106180	CH-12231 LBHR
4900154	CH10-12224 ALLIC	498 AIR	CH-13150 DX	5000241756	CH-12385 RENA	5011329	CH-12235 FDFS	5106182	CH-12386 LBHR
490238	CH06-11295 O&K	499 AIR	CH-12214 DX	5000241796	CH-12385 RENA	5011330	CH-12238 FDFS	5106189	CH-12385 LBHR
490328	CH06-11295 O&K	499208	CH04-11675 DYNAP	5000242503	CH-12242 RENA	5011331	CH-12660 FDFS	5106368	CH12-11389 LBHR
4907794	CH05-11106 ALLIC	499306	CH09-12244 DYNAP	5000242504	CH-12235 RENA	5011333	CH-12264 FDFS	5106509	CH-12238 LBHR
4907794	CH05-11106 FALLI	499307	ST09-12265 DYNAP	5000751590	CH-12507 RENA	5011334	CH-12247 FDFS	5106525	ST-13530 LBHR
4909733	CH08-12243 FALLI	499309	CH05-11106 DYNAP	5000751674	CH-15294 RENA	5011335	CH-12246 FDFS	5125568-00	CH-12262 YT
4916566M1	ST07-14270 H-H	499345	CH08-11288 DYNAP	5000783932	CH-12242 RENA	5011337	CH14-12245 FDFS	51278133	CH12-11389 I-R
4916567M1	CH07-14074 H-H	499346	ST08-11316 DYNAP	5000802977	ST-13531 RENA	5011338	CH-12278 FDFS	513605-M91	CH05-12222 M-F
4930052	CH-12660 DONIT	499514	SC-12274 DYNAP	5000802978	ST-13527 RENA	5011339	CH-12283 FDFS	5141521	CH08-12243 GMC
4930060	CH08-11288 DONIT	499553	CH10-11308 DYNAP	5000806317	CH-12278 RENA	5011340	CH-11211 FDFS	5-14215002-0	CH04-11675 ISZ
4930096	CH-12248 DONIT	4996253	CH05-11106 ALLIC	5000806377	CH-12278 RENA	5011343	PF-15680 FDFS	5-14215-002-1	CH04-11675 ISZ
4930098	CH-12249 DONIT	4F1007F	CH10-11308 NKK	5000807395	CH-13050 RENA	5011545	CH05-11106 FDFS	514795	CH-12262 JOY
4930140	CH-12285 DONIT	4G-3137	CH-12260 CAT	5000814797	CH-15565 RENA	5011547	CH-12231 FDFS	5150574	CH06-11295 DEMG
4930142	SC10-11317 DONIT	4ID1008F	CH12-12251 NKK	5000814798	SC-15604 RENA	5011549	CH08-11288 FDFS	515162	CH10-11308 DEMG
493016	CH09-12244 WAUK	4M-0383	CH-12208 CAT	5000814947	CH-13190 RENA	5011550	CH-12980 FDFS	515601	CH05-11106 TNT
493017	CH06-14733 WAUK	4M-2976	CH-12207 CAT	5000814950	CH-13939 RENA	5011551	CH-12232 FDFS	51561	CH05-11106 TNT
4930186	CH-12206 DONIT	4M-3803	CH-12260 CAT	5000814957	CH-13889 RENA	5011552	CH-12385 FDFS	5158658-00	CH05-11106 YT
493022	CH12-12251 DONIT	4M-3976	CH-12207 CAT	5000819339	CH12-11389 RENA	5011554	CH-12213 FDFS	5159998-00	CH-12209 YT
4930309	CH-12278 DONIT	4M-8047	CH-12208 CAT	5000819340	CH14-12245 RENA	5011556	CH-12242 FDFS	516566	CH08-12243 JOY
4930324	CH-12953 DONIT	4M-8048	CH-13157 CAT	5000819341	CH12-12251 RENA	5011557	CH-12248 FDFS	516716	CH08-12243 FORD
4930363	ST-13527 DONIT	4M9334	CH-12214 N/W	5000819342	CH-12282 RENA	5011558	CH12-12251 FDFS	51852110801	CH04-11675 KUBT
4930367	CH-12209 DONIT	4M-9334	CH-12214 CAT	5001 829 572	CH-12235 RENA	5011559	CH-16873 FDFS	518566	CH08-12243 JOY
4930372	ST-13530 DONIT	4M-9335	CH-13156 CAT	5001 834 600	CH-15300 RENA	5011560	CH-12235 FDFS	5190-0235	CH08-12243 JOY
4930384	SC12-11391 DONIT	4M-9339	CH-13156 CAT	5001836978	CH-15294 RENA	50133-GZ	CH04-11675 EZGO	520730	CH08-11288 MACO
4930387	CH-12225 DONIT	4M9378	CH-12207 N/W	500241796	CH-12385 RENA	501488	SC12-11391 HTCH	520731	ST08-11316 MACO
4930393	CH-12980 DONIT	4M-9378	CH-12207 CAT	500242503	CH-12242 RENA	50265321	CH12-12251 I-R	520837	CH12-11389 MACO
4930405	CH06-11295 DONIT	4M-9387	CH-12207 CAT	5002462	CH-11348 FDFS	502826	CH14-12245 HTCH	520942	CH06-11295 MACO
4930409	CH-12250 DONIT	4N0015	PF-14090 N/W	5004264	CH-12397 FDFS	502827	SC14-12254 HTCH	520943	ST06-11315 MACO
4930409	CH-16874 DONIT	4N0015	PFM-14095 N/W	5004772	CH12-11389 FDFS	502850	CH-12242 HTCH	5209957	CH10-11308 CLARK
4930432	CH06-11056 DONIT	4N-0015	PF-14090 CAT	5005004	CH05-11106 NEUS	50344878	CH-12260 I-R	52146958	CH18-17230 I-R
4930436	CH14-12245 DONIT	4N-0015	PFM-14095 CAT	5005028	ST05-14980 NEUS	5040251	CH08-12243 YT	52146966	SC18-17232 I-R
4930439	SC14-12254 DONIT	4N-0313	CH-12272 CAT	5006576	CH-11348 FDFS	5040T	CH-12177 COPR	521520-12510	CH04-11675 YNMR
4930440	ST-12226 DONIT	4N-0313X	CH-12272 CAT	5010 230 841	CH-16523 RENA	505001	CH-12262 WHITE	521542	CH09-12244 MACO
4930449	CH-12231 DONIT	4N-0326	CH-12271 CAT	5010 305 203	CH-15304 RENA	505412	CH-12232 DAF	521745	CH10-11308 MACO
4930487	ST-13529 DONIT	5.590.00.710.0	CH-16873 SDP	5010094092	CH-15294 RENA	50554518	CH-12260 I-R	522082536	CH-12712 WRTH
4930497	CH12-11389 DONIT	50 10 064 371	CH-15304 RENA	5010094154	CH-15304 RENA	505694	CH08-12243 DROT	522082536	CH-12712 WOPU
4930501	CH-12208 DONIT	50 10 064 372	CH-12507 RENA	5011304	CH-12231 FDFS	50616390	CH-12266 I-R	522082537	CH-12713 WRTH
4930506	CH-12236 DONIT	50 10 066 304	CH-15300 RENA	5011310	CH05-11106 FDFS	50616416	SC-12274 I-R	522082537	CH-12713 WOPU
4930509	CH09-12244 DONIT	50 10 066 387	SC-12252 RENA	5011316	CH08-11288 FDFS	50616424	CH-12273 I-R	522082538	CH-13948 WRTH
4930511	CH09-12244 DONIT	50 10 094 094	CH-15304 RENA	5011317	CH-12980 FDFS	506337	CH-16873 DAF	522082538	CH-13948 WOPU
4930513	CH-12246 DONIT	50 10 094 144	CH-12242 RENA	5011318	CH-12386 FDFS	506357	ST08-11110 AVBA	522082539	CH-13947 WRTH
4930515	CH-12247 DONIT	50 10 094 145	CH-12507 RENA	5011319	CH09-12244 FDFS	506645-M91	CH08-12243 M-F	522082539	CH-13947 WOPU
4930549	ST09-12265 DONIT	50 10 094 146	CH-15294 RENA	5011320	CH-12232 FDFS	5069734-01	CH08-12243 YT	522082544	CH05-14827 WRTH
4930550	ST-13531 DONIT	50 10 140 505	CH-12386 RENA	5011321	CH-12385 FDFS	507367	CH-12262 BKW	522082544	CH05-14827 WOPU

Number Finder



MFRS. NO.	OUR NO. MFR	MFRS. NO.	OUR NO. MFR	MFRS. NO.	OUR NO. MFR	MFRS. NO.	OUR NO. MFR	MFRS. NO.	OUR NO. MFR
52238T	CH-12249 COPR	541560	CH14-12245 BLOUN	569 AIR	ST08-11316 DX	5W-3403	CH-12276 CAT	6089378	CH12-11389 FDFS
52252061	CH18-17230 I-R	542653	CH06-12258 WIX	569000901	CH-17512 BOGE	5W-5889	CH08-11288 CAT	609374	SC12-11391 AGCH
52269875	CH-12273 I-R	546683	CH08-11935 WIX	56PS-4670	SC-12274 CHPN	5W-5890	ST08-11316 CAT	609421	CH12-11389 DROT
52277381	CH21-17070 I-R	54957	ST06-12048 BNFR	575	PF-15683 UN76	600 AIR	CH-13156 DX	610826/1	CH10-11308 DNS
5227739	SC21-17075 I-R	55.27655810	CH05-11106 SHAF	576975	ST06-11315 O&K	600023	CH12-12251 GEHL	61100190020	ST-13530 DMBZ
52402-00100	SC-12274 MTSB	5500416	CH08-12243 R-P	576977	ST06-11315 O&K	600-181-2461	CH-12605 KOMD	61100190020	ST-13530 SDP
524658	CH04-11675 O&K	5500560	SC12-11391 R-P	577 AIR	ST09-12265 DX	600-181-2500	CH-12604 KOMD	61100190028	CH-12386 SDP
524685	CH12-12251 O&K	5500611	CH05-11106 R-P	579873-M1	CH05-11106 M-F	600-181-3800	CH14-12245 KOMD	612.00.19.000	CH-12232 SDP
525611-M91	CH12-11389 M-F	55010001	CH06-11941 SMBR	57-MD-25	CH-12268 MACK	600-181-4211	SC14-12254 KOMD	612.00.19.002	CH-12386 SDP
525612-M1	SC14-12254 M-F	5501642705	CH-12285 KOMD	57-MD-310	CH-12268 MACK	600-181-4212	SC14-12254 KOMD	612.00.19.003	CH-12232 SDP
525612-M91	SC12-11391 M-F	5501642717	CH-12225 SHAF	581-02-12130	SC21-17075 KOMD	600-181-4230	SC14-12254 KOMD	6120	PF-15683 NAPA
525665	CH14-12245 BLOUN	5501642727	ST-16876 SHAF	583135	CH09-12244 O&K	600-181-4300	CH14-12245 KOMD	61200190033	ST-13531 DMBZ
526023	CH05-11106 AMHO	5507989	CH08-11288 LBHR	583136	ST09-12265 O&K	600-181-4311	CH14-12245 KOMD	61200190033	ST-13531 SDP
528052	CH10-12390 MACO	5507991	CH14-12245 LBHR	583226	CH-12980 O&K	600-181-4330	CH14-12245 KOMD	61200190037	CH-12385 SDP
528052	CH10-14455 MACO	550799214	CH14-12245 LBHR	584576	CH-12235 PGSO	600-181-4600	CH14-12245 KOMD	61200190701	CH-12232 SDP
5295	CH-12273 NAPA	5507994	CH18-17230 LBHR	589 AIR	CH-12403 DX	600-181-6360	SC10-11317 KOMD	612-6305	CH-12262 COOK
5296T	CH-12839 COPR	5507995	SC18-17232 LBHR	58923442	ST08-11316 I-R	600-181-6560	SC12-11391 KMTS	6127-81-7310	CH16-12253 KOMD
529821-R1	CH12-11389 CASEI	5512140	CH05-11467 DROT	589562	CH12-12251 O&K	600-181-8260	CH10-11308 KOMD	6127-81-7320	CH16-12253 KOMD
529821-R2	CH12-11389 CASEI	5527655841	CH04-11675 KOMD	59046797	CH08-14410 I-R	600-181-8300	CH10-11308 KOMD	6127-81-9031	SC-12252 KOMD
529852-R2	ST06-11315 CASEI	552894	CH12-12251 CLS	59046805	ST08-14413 I-R	600-181-8360	SC10-11317 KOMD	6133	PF-15684 NAPA
529852-R3	ST06-11315 CASEI	555-08304-015	SC14-12254 MAN	59106393	CH08-17365 I-R	600-181-9200	CH08-11288 ALSKD	614103	CH14-13356 ALLIC
529852-R4	ST06-11315 CASEI	556012165	CH09-12244 RICH	59133	CH06-14733 NEWH	600-181-9200	CH08-11288 KOMD	614103	CH14-13356 NEWH
529852-R5	ST06-11315 CASEI	556012179	ST06-11315 RICH	59144170	CH06-16050 I-R	600-181-9240	CH08-11288 KOMD	614104	SC14-13357 ALLIC
5300504	CH05-11467 YT	556012181	CH08-11288 RICH	59144188	ST06-16054 I-R	600-182-1100	CH05-11106 KOMD	614104	SC14-13357 NEWH
530270-R2	SC12-11391 CASEI	556012182	CH08-11288 RICH	59341560	CH-13824 I-R	601-T-125	CH-12262 VERS	6155529	CH06-11056 CARA
534478	CH-12386 PGSO	556012183	ST08-11316 RICH	59407973	CH04-11675 I-R	602 190	CH-12285 KSR	6155539	CH05-11106 CARA
535-00316	CH10-12224 BARKH	556012184	CH06-11295 RICH	59438804	CH08-11288 I-R	6024-1760	CH05-11106 LSTRP	6155540	CH-11348 CARA
535-00422	CH10-12224 BARKH	556012185	CH09-12244 RICH	594686-R91	CH05-11106 IHCH	602450	CH05-11106 R-P	6155543	ST05-11108 CARA
535-01025	CH06-14733 BARKH	556012186	ST09-12265 RICH	59501503	CH10-11308 HEDEN	602450-1	CH05-11106 R-P	61583385	CH-12288 FIATH
53521226	CH08-11288 BMG	556012187	CH08-11288 RICH	595601	CH-12215 ALLIC	604334	CH05-11106 WAYN	61643A	CH-12262 BRAY
537335-R1	ST-12226 CASEI	556012189	CH08-11288 RICH	595602	CH-12215 ALLIC	60441	CH05-11106 LACR	616513	CH05-11106 CLARK
537335-R2	ST-12226 CASEI	556012190	ST08-11316 RICH	595603	CH-12216 ALLIC	604948	SC14-12254 GETMA	616520	CH05-11106 FORD
537335-R3	ST-12226 CASEI	556012193	CH12-12251 RICH	595604	CH-12216 ALLIC	604950	CH14-12245 GETMA	61654541	CH12-11389 IVCO
537986	CH08-11003 BLOUN	556012197	CH05-11106 RICH	59567255	CH06-14733 I-R	605412970031	CH-12980 MWM	616720	CH05-11106 FORD
537987	ST08-11110 BLOUN	556012198	SC10-11317 RICH	597 AIR	CH-12207 DX	605412970032	CH-12386 MWM	61807.4	ST06-12048 SMBR
538214	CH09-12244 BLOUN	556012199	CH10-11308 RICH	597033071	CH09-12244 RICH	605412970033	CH-12232 MWM	6188	CH-12206 NAPA
538235	CH12-11389 BLOUN	560 1963	ST-13527 LBHR	598 AIR	CH-13157 DX	605412970034	CH-12385 MWM	619 960	CH-12386 KSR
538237	CH14-12245 BLOUN	5600615	CH-12269 LBHR	59825562	CH10-11308 I-R	605413900006	CH05-11106 MWM	61908-00100	SC14-12254 MTSB
538239	CH08-11288 BLOUN	5601964	CH-12242 LBHR	59888891	CH08-11288 I-R	60608-00800	CH14-12245 MTSB	6191362M1	CH04-14412 M-F
53953.6	ST06-11315 SMBR	5604683	SC-12274 LBHR	599 AIR	CH-12208 DX	6061641	CH06-12258 FDFS	619675-C91	CH-12260 IHCH
54012007	CH-12209 SMBR	563415	ST08-14708 MNTO	599753	CH-12269 O&K	606341/2	CH12-12251 DNS	619689-C91	CH-12260 CASEI
5410612	CH-12870 FARY	563416	CH08-14703 MNTO	599756	CH-12269 O&K	606901670110	CH-12278 MWM	619970	CH-12385 KSR
5412-2915-00	CH08-11288 ATCO	565487	CH08-11003 BLOUN	599757	SC-12270 O&K	606901670111	ST-13528 MWM	619990	ST-13531 KSR
54141	CH05-11106 TNT	565526	ST09-12265 BLOUN	5A-230	CH-12262 GDDN	606901670113	CH-12386 MWM	6210	CH-12847 NAPA
54141-1	CH05-11106 TNT	565527	CH09-12244 BLOUN	5B-346	CH-12262 GDDN	606901670114	ST-13530 MWM	621128	CH-12208 CLARK
5415-2915-00	CH08-11288 ATCO	565528	CH09-12244 BLOUN	5B-469	CH-12266 GDDN	606901670115	ST-13531 MWM	62300685	SC-12252 BUCYE
5415-2915-00	CH08-11288 ATCO	567 AIR	CH08-11288 DX	5W-2716	ST09-12265 CAT	606901670116	CH-12385 MWM	62300686	CH16-12253 BUCYE
5415-2916-00	ST08-11316 ATCO	56778442	CH-12269 I-R	5W-2717	CH-12286 CAT	607179	CH-12235 DAF	6241405	CH18-17230 VME
541559	CH14-12245 BLOUN	56778459	SC-12270 I-R	5W-3402	SC10-11317 CAT	6072-2214-00	CH10-12224 MTSB	6241406	SC18-17232 VME

Number Finder



MFRS. NO.	OUR NO. MFR	MFRS. NO.	OUR NO. MFR	MFRS. NO.	OUR NO. MFR	MFRS. NO.	OUR NO. MFR	MFRS. NO.	OUR NO. MFR
625	SC10-11317 GLN	6424409	CH-13157 GMC	6510	CH-12225 NAPA	6642	CH-12276 NAPA	677-434	CH-12385 CLAS
62608-00200	CH14-12245 MTSB	6424410	CH-13150 GMC	6515	CH-12386 NAPA	6642047	ST-13531 VOLV	677-4340	CH-12385 CLAS
6263	ST05-14980 NAPA	6424687	CH12-12251 GMC	6517	ST-13410 NAPA	6643	SC10-11317 NAPA	682994	CH10-12224 TOWM
6270	CH04-11675 NAPA	6424688	CH05-11106 GMC	6518192	CH05-11106 CLARK	66448.2	CH08-17365 SMBR	683 AIR	SC21-17075 DX
6274	CH-12215 NAPA	6424692	CH-12209 GMC	6522	ST08-11316 NAPA	6644839	CH-12386 VOLV	684 AIR	CH21-17070 DX
6278976-C1	SC14-13357 CASEI	6425549	CH10-11308 LBHR	6525	ST-13531 NAPA	6644840	ST-13530 VOLV	684163	CH08-12243 TOWM
627975-C2	CH14-13356 CASEI	6425550	SC10-11317 LBHR	6526	CH06-11941 NAPA	66449.0	ST08-14413 SMBR	684732/1	CH10-11308 FALLI
627975-C2	CH14-13356 FKWA	6425723	CH12-11389 LBHR	653 AIR	PF-15677 DX	6644988	ST-13531 VOLV	6852	CH-12289 NAPA
627975-C3	CH14-13356 CASE	6425724	SC12-11391 LBHR	6532	ST-13530 NAPA	6644988-5	ST-13531 VOLV	6868	CH-11020 NAPA
627976-C1	SC14-13357 CASEI	643.169.0	CH-12235 CLAS	6534	CH-12867 NAPA	6644990	CH-12242 VOLV	686911	CH08-11003 TOWM
6294	CH-12091 NAPA	6430	CH-12231 NAPA	6537	CH08-12228 NAPA	6644990-1	CH-12242 VOLV	687743	CH10-12224 TOWM
6304	CH05-12222 NAPA	64320-10415	SC-12274 MTSB	6537850	CH05-11106 YT	6644991	CH-12242 VME	687744	CH08-12243 TOWM
630710	CH-12207 CLARK	643-331	ST-13529 CLAS	6538	ST08-12229 NAPA	6645119	CH12-11389 VOLV	687746	CH08-12243 TOWM
631200870	CH12-11389 VHOL	643331.0	ST-13529 CLAS	6541	CH-12242 NAPA	6645119-6	CH12-11389 VOLV	689 AIR	CH-12269 DX
631201530	CH-12235 VHOL	645110V	CH-12386 TOWM	6544578	CH05-11106 CLARK	664578	CH05-11106 WHITE	6897064	CH-12225 VOLV
631202860	CH-12234 VHOL	6-4520-0	CH05-11106 CSTV	6546	CH-12232 NAPA	6645833	ST-13531 VOLV	691.030	CH09-12244 PGSO
6313	CH-12397 NAPA	6-4520-002	CH05-11106 CSTV	6547	CH-12283 NAPA	6646003-001	CH06-12258 LANLI	691.031	ST09-12265 PGSO
631401380	CH-12238 VHOL	645372	CH-12385 PGSO	6554	CH-12385 NAPA	6646494	CH05-11106 BOBC	691.351	CH-12385 PGSO
632114	CH-12242 PGSO	6-4545-0	CH05-11106 CSTV	6-55FPS1087	CH12-11389 CNPN	6646494	CH05-11106 MLRO	69100108	CH14-12245 HSC
6327	CH-12272 NAPA	6-4545-005	CH05-11106 CSTV	6560	ST09-12265 NAPA	6652	CH07-14074 NAPA	691-00108	CH14-12245 LSTRP
6328	CH-12247 NAPA	6466	CH08-12228 NAPA	6561	CH-12286 NAPA	66544-001	SC-12270 VERMR	691280	ST-13529 DAF
6330	CH-12285 NAPA	6467	ST08-12229 NAPA	6569	ST08-14413 NAPA	66602-01800	CH10-11308 MTSB	692380	ST-13531 DAF
6340310	CH05-11106 GLDI	6486	CH05-11106 CMPR	657564.0	ST-13527 CLAS	66602-03700	SC10-11317 MTSB	694218	CH-12278 DAF
6340317	ST05-11108 GLDI	6486931	CH12-11389 GMC	6580	PF-14090 NAPA	6663418	CH05-11106 CLARK	695 AIR	CH-12209 DX
6340328	CH08-11003 GLDI	6486941	CH-12273 GMC	6580	PFM-14095 NAPA	6666333	CH06-16050 BOBC	6950541	CH-12262 YT
6340366	CH08-11998 GLDI	6487	CH08-12228 NAPA	6594	CH-12234 NAPA	6666334	ST06-16054 BOBC	6951549	CH-12260 YT
6340421	ST-12106 GLDI	6487013	SC-12274 GMC	6598222	ST05-14980 BOBC	6666376	ST07-14270 CLARK	6952789	CH10-11308 YT
634478	CH-12386 PGSO	6487036	CH14-12245 GMC	6598222	ST05-14980 CLARK	6666376	ST07-14270 MLRO	6953030	CH16-12253 YT
634479	CH-12231 PGSO	6487136	SC14-12254 GMC	6598362	ST06-11109 BOBC	667078	CH-12387 IVCO	6953031	SC-12252 YT
63496.4	CH07-14865 SMBR	6487244	CH-12269 GMC	6598362	ST-14343 CLARK	6671969	ST08-11110 BOBC	6953104	CH12-11389 YT
63497.2	ST07-14270 SMBR	6487246	SC-12270 GMC	6598491	CH05-11106 CLARK	6672467	CH05-15887 BOBC	6953105	SC12-11391 YT
6351	CH-12213 NAPA	648734	CH14-12245 ALLIC	6598898	ST06-11315 CLARK	6675974	CH12-12251 PURO	6953106	SC14-12254 YT
6352	CH-12403 NAPA	6487434	CH05-12222 GMC	66002073	CH12-12251 PERL	6676852	SC-12274 ALLIC	6953107	CH14-12245 YT
6360	CH05-11106 NAPA	6487468	SC12-11391 GMC	6606	CH06-11295 NAPA	6678200	CH12-11389 PURO	695633	CH-12386 DAF
6375	ST08-11110 NAPA	6487754	CH10-11308 GMC	6612504	CH-12213 VOLV	6678201	CH14-12245 PURO	6962224	CH12-11389 WERK
6378	CH-12605 NAPA	6487756	SC10-11317 GMC	6613	CH-13270 NAPA	668373	CH08-12243 TOWM	6962225	SC12-11391 WERK
640114	CH08-11288 WHITE	6488182	CH-14104 GMC	6616	CH-12262 ACM	6696758	CH21-17070 PURO	69800011	CH07-14865 HEDEN
6407	ST-14715 NAPA	6488338	CH-12275 GMC	6620140	CH05-11106 CLARK	66U12155	CH05-11106 CRRER	698089	CH-12235 PGSO
64071475	CH12-12251 NATL	6488342	CH04-11675 GMC	6625	CH08-11942 NAPA	66U1-5262-1	CH05-11106 CRRER	699435	ST-13527 PGSO
6408	CH-12485 NAPA	6488346	CH08-11288 GMC	6626089	SC10-11317 ALLIC	670000-24	CH14-12245 RAGO	6A-5110	CH-12386 CAT
6414	CH-12248 NAPA	6489T	CH-12212 COPR	6626089	SC10-11317 FALLI	670000-37	CH05-11106 RAGO	6A-5110V	CH-12386 CAT
6420403	CH-12262 GMC	6496	CH-12716 NAPA	6626097	SC12-11391 ALLIC	670000-42	CH10-12224 RAGO	6A-5162	CH-12397 CAT
6421537	CH-12262 GMC	6498	CH-12491 NAPA	6626097	SC12-11391 FALLI	670000-43	CH14-12245 RAGO	6A-5162V	CH-12397 CAT
6421538	CH-12208 GMC	650152	CH12-11389 CECO	662689/9	SC10-11317 ALLIC	670000-44	CH-12266 RAGO	6DD-0330	CH-12262 WHITE
6421539	CH-12210 GMC	650156	CH08-12243 W&S	6630939	CH06-14733 CLARK	6711326	CH-12271 PURO	6F-2647B	ST08-11316 FORD
6421540	CH-12214 GMC	6502	CH-14722 NAPA	663384	CH08-12243 TOWM	6711329	CH-12272 PURO	6I6582	SC12-11391 CAT
6421541	CH-12207 GMC	6504	CH-14334 NAPA	6639203	CH-12839 VOLV	6741	CH-12278 NAPA	6L-3313	CH-12260 CAT
6423136	CH-12260 GMC	650577	CH14-12245 CECH	6639203-6	CH-12839 VOLV	674967	CH-12273 ALLIC	6L4714	PF-15677 NW
6423137	CH-13156 GMC	650930	CH14-12245 CECO	6640289	CH-12235 VOLV	676-600	CH-12386 CLAS	6L-4714	PF-15677 CAT

Number Finder



MFRS. NO.	OUR NO. MFR	MFRS. NO.	OUR NO. MFR	MFRS. NO.	OUR NO. MFR	MFRS. NO.	OUR NO. MFR	MFRS. NO.	OUR NO. MFR
6L-6873	PF-15677 CAT	70113-N	SC-12274 NW	70267962	SC10-11317 FALLI	70615-N	ST06-11315 NW	71415282	CH10-14455 FAGRI
6LS551A/4	CH-12235 PRKN	70114N	CH-12273 NW	70269-N	SC14-12254 NW	70617-N	CH05-11467 NW	71416994	SC10-12395 FIATH
6N-6064	CH-12273 CAT	701165	CH10-11308 AGCH	702753-C1	SC-12274 CASEI	70627N	CH-12403 NW	71420350	CH-12345 FALLI
6N-6065	SC-12274 CAT	701195	CH-12262 CECH	70293	CH06-14733 NW	706396	CH12-12251 CECO	71467030	CH10-12390 FIATH
6PS-2690	CH08-12243 CHPN	70120-N	CH-12282 NW	70293-N	CH06-14733 NW	706425	CH12-11389 CECO	71467030	CH10-14455 FIATH
7 367 183	CH-12235 LBHR	70121-N	SC21-17075 NW	70301-N	CH10-11308 NW	70648734	CH14-12245 FALLI	71467031	SC10-12395 FIATH
70000-11080	CH06-11038 KUBT	70125-N	CH21-17070 NW	70302N	CH09-12244 NW	70654409	CH10-11308 FALLI	7178A	CH-13763 SOFM
70000-11081	CH05-11106 KUBT	70129-N	SC14-13357 NW	703112	CH08-12243 AVCO	70659387	CH16-12253 FALLI	718023	CH12-11389 O&K
70000-11221	CH04-11675 KUBT	701419	CH-12262 CECO	703112	CH08-12243 WHITE	70659533	CH14-12245 FALLI	718024	SC12-11391 O&K
70000-14500	CH06-11038 KUBT	701468	CH-12091 LBHR	70333	ST08-11316 NW	70660360	CH12-11389 FALLI	718057	ST08-11316 O&K
700016	CH16-12253 GMC	70172-N	CH18-17230 NW	70333N	ST08-11316 NW	70660360/9	CH12-11389 FALLI	718058	CH08-11288 O&K
70002402	ST-16487 LBHR	70181-N	CH12-12251 NW	70334	CH08-11288 NW	70662477	SC14-12254 FALLI	718059	ST08-11316 O&K
70002403	CH-12231 LBHR	70189-N	CH-14104 NW	70334N	CH08-11288 NW	70662608	SC10-11317 FALLI	718325	CH-12266 O&K
70002639	ST08-11316 LBHR	70194-N	CH06-11056 NW	70338-N	ST08-11316 NW	70662609	SC12-11391 FALLI	71909116	CH08-12228 FALLI
700052302	CH-12794 FALLI	70197588	SC-12252 FALLI	70344N	ST-14343 NW	70662689/9	SC10-11317 FALLI	71909128	CH06-11056 FALLI
70005286	CH10-11308 LBHR	70198-N	CH-12260 NW	70367	ST06-11315 NW	7066432	SC10-11317 FALLI	71909129	ST-12226 FALLI
70005287	SC10-12395 LBHR	70203-N	SC10-11317 NW	70367N	ST06-11315 NW	70666432	CH10-11308 FALLI	71909136	CH12-11389 FALLI
70005331	SC-12270 LBHR	70206-N	CH05-11106 NW	70398-N	CH-12268 NW	70667685	SC-12274 FALLI	71909140	ST-12226 FALLI
700053475	ST06-12048 FALLI	70220-N	CH-12249 NW	70410N	ST09-12265 NW	70667686	CH-12273 FALLI	71909141	CH06-11056 FALLI
70005424	CH08-11288 LBHR	70226-C	CH05-11106 NW	70413-N	CH-12214 NW	70667690	CH-12273 FALLI	71930174	CH12-11343 FALLI
700055856	CH-12345 FALLI	702322-C1	CH14-12245 CASEI	70415-N	CH-13157 NW	70674967	CH-12273 FALLI	71930174	CH-13477 FALLI
7000738	CH-12232 LBHR	702323-C1	SC14-12254 CASEI	704314	CH-12268 GMC	70684732	CH10-11308 FALLI	71930175	SC10-11317 FALLI
70060-N	CH-12269 NW	70237395	CH-12209 FALLI	70440155	CH06-11295 FALLI	70684732/1	CH10-11308 FALLI	720189	CH12-11389 AGCH
70062-N	CH-12209 NW	70237-N	CH14-12245 NW	70440158	ST06-11315 FALLI	70684733	CH12-11389 FALLI	720257	CH08-11003 AGCH
70063-N	CH14-12245 NW	70239513	CH05-11106 FALLI	7047	CH10-12224 NAPA	70684734	CH14-12245 FALLI	720258	CH10-12224 AGCH
70067-N	SC12-11391 NW	70239518	CH05-11106 FALLI	7048	SC-12252 NAPA	7072938	ST06-11315 ELGS	72056	CH12-12251 FLDO
70070	CH12-11389 NW	702415	CH-12262 CECH	70482N	CH05-12222 NW	707664	CH-12260 CECO	72083768	SC12-11391 FALLI
70070-N	CH12-11389 NW	70244570	SC12-11391 FALLI	70497N	ST-13410 NW	70819N	SC10-12395 NW	72083771	CH12-11389 FALLI
70071-N	SC-12270 NW	702455	CH14-12245 AGCH	70515N	ST08-11110 NW	70831N	CH-12276 NW	72097035	CH05-11106 FALLI
70072N	CH-12266 NW	702463	SC14-12254 AGCH	70517N	ST-12226 NW	70849N	CH-12286 NW	72097371	CH05-11106 ALLIC
70077	CH14-13356 NW	70247060	CH04-11675 FALLI	7052	CH16-12253 NAPA	70868N	CH-12605 NW	721012	SC-12252 AGCH
70077N	CH14-13356 NW	70250699	CH05-11106 FALLI	70530N	CH-12491 NW	708722126	CH12-11389 HESTN	721237	CH12-11389 AGCH
7008166	CH10-11308 VOLV	70250N	CH05-11467 NW	70588-S	CH-12215 NW	708722134	SC12-11391 HESTN	721237023A	CH12-11389 AGCH
7008443	CH18-17230 LBHR	70251-N	CH-13156 NW	70591-S	CH-12216 NW	708748	CH14-12245 CECH	72257812	SC10-12395 ALLIC
70089-N	CH-12262 NW	70252-N	CH-13150 NW	70594-S	CH-12250 NW	708962A1	PF-16591 MCCO	723360-M91	CH08-12243 M-F
7009285	CH12-11389 LBHR	70254-N	CH-12207 NW	70594-S	CH-16874 NW	70903N	CH-12485 NW	723-561	CH-12231 CLAS
7009286	SC12-11391 LBHR	70256395	CH09-12244 FALLI	70595601	CH-12215 FALLI	70954N	CH05-15887 NW	726199-M1	CH08-11288 M-F
7009363	CH08-11288 VOLV	70256983	CH08-11288 FALLI	70595602	CH-12215 FALLI	71005365	CH08-12243 FALLI	726960	CH12-12251 CLS
7009375	SC10-11317 VOLV	70257024	CH08-11288 FALLI	70595603	CH-12216 FALLI	71007973	CH08-11288 FALLI	726988	CH-12262 AVBA
7009410	ST08-11316 VOLV	70257029	ST08-11316 FALLI	70595604	CH-12216 FALLI	71007974	ST08-11316 FALLI	7277153200	CH-14237 M-F
70098	CH04-11675 NW	70257597	CH05-11106 FALLI	70595-S	CH-11348 NW	71010407	CH08-11288 FALLI	728339	CH-12262 WBCO
70098N	CH04-11675 NW	70258-N	CH-12210 NW	70597-S	CH-12839 NW	71014652	CH05-11467 FALLI	728340	CH-12262 WBCO
701009/E	CH-12135 ALFA	70259-N	CH-13141 NW	70603-S	PF-15677 NW	71140887	CH08-12243 FALLI	730190101	CH06-11056 AGRF
70101-N	SC12-11391 NW	70261-N	CH-12208 NW	70604-S	CH-12231 NW	71140889	CH05-11106 FALLI	730190201	CH05-12222 AGRF
70102-N	CH08-11288 NW	70264740	CH-12269 FALLI	70605-S	CH-12091 NW	71181296	ST09-12265 FALLI	730190601	CH06-11295 AGRF
70104-N	SC10-11317 NW	70266787	CH09-12244 FALLI	70608-S	CH-12264 NW	71183993	SC10-11317 FALLI	73039681	CH12-12251 FALLI
7010578	SC14-12254 LBHR	70267075	CH09-12244 FALLI	70609-S	ST09-12265 NW	71405431	CH08-14835 FIATH	7-304-00011	CH10-11308 GRV
70107974	ST08-11316 FALLI	70267931	SC10-11317 FALLI	70611-S	CH08-12228 NW	71406283	ST08-12229 FIATH	7-304-100001	CH14-12245 GRV
70108-N	CH08-12221 NW	70267953	ST09-12265 FALLI	70612-S	ST08-12229 NW	71415282	CH10-12390 FAGRI	73042922	CH12-11389 FALLI

Number Finder



MFRS. NO.	OUR NO. MFR	MFRS. NO.	OUR NO. MFR	MFRS. NO.	OUR NO. MFR	MFRS. NO.	OUR NO. MFR	MFRS. NO.	OUR NO. MFR
73044713	CH08-12243 FALLI	74055126	CH-12262 FALLI	76568665	CH-12739 FIATH	78722126	CH12-11389 FALLI	79933225	CH08-12228 FALLI
7304497	CH12-12251 FALLI	74055745	CH-11348 FALLI	76579880	CH-12770 FIATH	78822161	CH-12204 FALLI	79933226	ST08-12229 FALLI
7304539	CH05-11106 KRNG	7412732	CH-16928 LBHR	765821	ST-13530 O&K	789 AIR	CH-14104 DX	79933276	CH14-12245 FALLI
73045860	CH12-12251 FALLI	7412733	ST10-15380 LBHR	76585406	CH04-11675 FIATH	789554	CH-12262 WHITE	79935594	CH09-12244 FALLI
73047497	CH12-12251 FALLI	74146001	CH-11348 FALLI	76611-58420	CH04-11675 KUBT	7901-1296	ST06-12048 ZETOR	79955749	ST-12226 FALLI
73050258	CH12-11389 FALLI	74357487	CH-12262 FALLI	76626089	SC10-11317 FALLI	79011386	CH08-11288 FALLI	79955976	CH06-11056 FALLI
73051818	CH12-12251 FALLI	7-437-100135	CH12-11389 GRV	76626097	SC12-11391 FALLI	79011387	ST08-11316 FALLI	79957810	ST-12226 FALLI
73067507	CH08-11288 FALLI	74371576	CH-11348 FALLI	766442-C91	CH14-12245 IHCH	79022025	CH06-11056 FALLI	79957811	CH06-11056 FALLI
73067508	ST08-11316 FALLI	744821	CH-12386 O&K	76676852	SC-12274 FALLI	79022026	ST-12226 FALLI	79957888	SC10-11317 FALLI
7308924	CH-12262 PURO	746	CH12-11389 CRSL	768 AIR	SC10-11317 DX	79042202	CH-12286 FALLI	79957889	CH12-11389 FALLI
73119795	CH08-11288 FALLI	7475191	SC12-11391 VOLV	768394-C91	CH-12262 IHCH	79042203	ST09-12265 FALLI	79HF-9601-BA	CH06-12258 FORD
73430	CH16-12253 FLDQ	7475191-8	SC12-11391 VOLV	768395-C91	CH-12262 IHCH	79043778	CH12-11389 FALLI	7E-0973	CH-12286 CAT
73431	SC-12252 FLDQ	74789056	CH05-11106 FALLI	769432-C91	CH14-12245 IHCH	79043778	CH12-11389 NEWH	7E0974	CH09-12244 CAT
735724	CH12-11389 LEYL	74841879	CH05-11106 FALLI	769436-C91	CH14-12245 IHCH	79043779	SC12-11391 FALLI	7E0975	CH08-11288 CAT
7360149	CH09-12244 LBHR	74861641	CH08-12243 FALLI	769436-C92	CH14-12245 IHCH	79043780	CH14-12245 FALLI	7M9045	CH-12210 NW
7360150	ST09-12265 LBHR	74907794	CH05-11106 FALLI	769722-C91	CH12-12251 IHCH	79043781	SC14-12254 FALLI	7M-9045	CH-12210 CAT
7360230	ST08-11316 LBHR	74909733	CH08-12243 FALLI	77 01 025 065	ST-16488 REAG	79049790	ST06-11315 FALLI	7M-9046	CH-13150 CAT
7360733	ST-13531 LBHR	74971959	CH-12204 FALLI	7701019017	CH-12386 RENA	79049791	CH06-11295 FALLI	7W-3920	CH-12207 CAT
7360753	CH-12385 LBHR	74972500	CH-12204 FALLI	7701019018	ST-13530 RENA	79062700	ST06-12048 FALLI	7W-5316	CH-12210 CAT
7360972	CH-12276 LBHR	74972550	CH-12204 FALLI	7701021498	ST-13531 RENA	79067204	CH08-11935 FALLI	7W-5317	CH-12214 CAT
7360973	SC10-11317 LBHR	74980649	CH-12235 FALLI	7701027436	CH-12500 RENA	79067204	CH08-11935 IVCO	7W-5389	CH-12208 CAT
7361346	ST-13530 LBHR	74996253	CH05-11106 FALLI	7701027437	CH-12279 RENA	79072797	CH08-11935 FALLI	7W-7424	CH-12268 CAT
7361347	CH-12386 LBHR	750205-C91	CH12-12251 IHCH	77021413	CH12-12251 FALLI	79081327	CH06-11056 FALLI	7X6041	PF-15669 CAT
7361355	CH-12266 LBHR	75060642	CH12-11389 CHRYS	771456-C91	CH12-12251 IHCH	79081328	ST-12226 FALLI	8003742	ST-13530 O&K
7362224	CH-12385 VOLV	751754	CH08-11935 WIX	771456-C92	CH12-12251 IHCH	79083212	CH08-11288 FALLI	8003751	CH-12235 O&K
7362224-3	CH-12385 VOLV	75247062	CH-12385 FALLI	771456-C93	CH12-12251 IHCH	79083213	ST08-11316 FALLI	8005628	CH-12839 O&K
7362587	SC14-12254 LBHR	75247063	ST-13531 FALLI	77306750	CH08-11288 FALLI	79083213	ST08-11316 IVCO	8005814	ST-13531 O&K
7362686	CH14-12245 LBHR	75248729	CH-12242 FALLI	773305-C91	CH12-12251 IHCH	79103228	CH12-11389 HALL	8006	PF-15686 CRSL
7362687	SC14-12254 LBHR	752616-C91	CH12-12251 IHCH	773604	ST-13531 O&K	79199899	CH-12260 VOLV	8006605	CH-12385 O&K
7363362	CH10-11308 LBHR	757-27890	CH-18672 LSTRP	773605	CH-12385 O&K	79200549	CH-12266 VOLV	8011014	CH08-12243 FALLI
7364869	CH18-17230 LBHR	758008-C91	CH-12262 IHCH	774564-C91	CH12-12251 IHCH	79205191	CH-12232 VOLV	80110141	CH08-12243 FALLI
7364870	SC18-17232 LBHR	75PS-2690	CH12-12251 CHPN	774592	CH14-12245 CAT	79230041	CH-12260 VOLV	801101411	CH08-12243 FALLI
7367182	ST-13529 LBHR	76.50.092	PF-15677 GSCO	775869	CH12-12251 CAT	79253654	SC-12274 VOLV	801155191	CH-12238 BSS
7368215	ST-17470 LBHR	76040385	SC14-12254 FIATH	776258	SC14-12254 CAT	79253662	CH-12273 VOLV	801155196	CH-12234 BSS
7370955	CH-16294 LBHR	76040386	CH-12266 FIATH	77659533	CH14-12245 FALLI	79258257	CH12-12251 VOLV	8014390	CH08-11288 IVCO
737095503	CH-16294 LBHR	760884	ST-13531 PGSO	776604	ST-13531 O&K	79292365	CH-12397 FALLI	8014410	CH10-11308 IVCO
7370956	SC-16301 LBHR	7610-9223	CH14-12245 BDGER	77662477	SC14-12254 FALLI	79359626	CH-12242 VOLV	8014430	CH08-11003 IVCO
7371156	ST10-15380 LBHR	76141573	CH18-17230 DEMG	77722126	CH12-11389 FALLI	79384772	CH14-12245 VOLV	8015448	ST08-11110 IVCO
7371157	CH-16928 LBHR	76141673	SC18-17232 DEMG	77825060	CH09-12244 FALLI	79384780	SC14-12254 VOLV	8015449	ST08-11316 IVCO
739051	CH08-12243 JGR	761490-C91	CH12-12251 IHCH	77980508	CH-12276 FALLI	79443768	CH-12345 VOLV	8015450	SC10-11317 IVCO
739472	CH-12209 LEYL	7615526	CH08-11942 LBHR	78041782	CH14-12245 FALLI	797358-C91	CH-12282 IHCH	8015977	SC14-13357 FALLI
739472	CH-12209 LONG	7619404	CH08-14410 LBHR	78322121	CH-12215 FALLI	7980474	PF-15680 GMC	8016660	CH12-11388 IVCO
7401179	CH-12286 LBHR	7619405	ST08-14413 LBHR	78322122	CH-12216 FALLI	7980585	PF-15680 GMC	8016666	ST12-11390 IVCO
7401316	CH09-12244 LBHR	762792	CH-12225 O&K	78322128	CH-12216 FALLI	7987956	CH-12209 GMC	8016966	SC14-12254 IVCO
7402026	CH-13050 LBHR	763 AIR	SC14-12254 DX	78322129	CH-12215 FALLI	7987957	CH12-11389 GMC	8016967	CH14-12245 IVCO
7402027	SC10-11317 LBHR	764 AIR	SC-12274 DX	78332987	CH-12273 FALLI	79917419	CH12-12251 FALLI	8016976	CH14-13356 FALLI
74021443	CH08-12243 FALLI	765 AIR	CH-12273 DX	785 AIR	ST06-11315 DX	79917881	CH12-12251 FALLI	8016976	CH14-13356 IVCO
7405233	CH-12798 LBHR	76547841	CH06-16050 FIATH	78721029	SC14-12254 FALLI	79921320	CH12-11389 FALLI	8016977	SC14-13357 IVCO
74055125	CH-12262 FALLI	765568	CH-12397 O&K	78721219	ST09-12265 FALLI	79923130	CH12-11389 FALLI	8019342	CH12-13632 IVCO

Number Finder



MFRS. NO.	OUR NO. MFR	MFRS. NO.	OUR NO. MFR	MFRS. NO.	OUR NO. MFR	MFRS. NO.	OUR NO. MFR	MFRS. NO.	OUR NO. MFR						
8019343	SC12-13636	IVCO	81.08304.0066	ST-17470	MAN	82003739	ST-14715	NEWH	8351075	CH14-12245	CLS	848101155	CH08-11288	FAIEX	
8020729	CH-13880	FALLI	81.08304.0083	CH-14900	MAN	82004413	ST-17092	NEWH	836	AIR	CH12-11389	DX	84824-S	CH08-11288	NW
8020729	CH-13880	IVCO	81.08304.0094	CH-14900	MAN	82008597	ST-17092	NEWH	836115237	CH-12980	VMET	84826-S	CH09-12244	NW	
8023027	CH-14111	FALLI	81.0830424	CH-12234	MAN	82008600	CH-14722	NEWH	83627-A	PF-15677	NW	84839-S	CH-12289	NW	
8023027	CH-14111	IVCO	81.08405.0008	ST-13527	MAN	82008601	ST-14715	NEWH	83627N	PF-15677	NW	84857-S	PF-15683	NW	
8025818	CH16-12253	IVCO	81.08405.0011	ST-13528	MAN	82008607	ST-17103	NEWH	836316408	CH-12385	VMET	848623-R1	SC12-11391	CASEI	
8031211	CH07-14074	IVCO	81.08405.0013	ST-13528	MAN	82011402	CH-14722	NEWH	83722N	CH-12847	NW	84864-S	CH-12781	NW	
8031565	ST07-14270	IVCO	81.08405.0024	CH-12234	MAN	82034441	ST-17103	CASE	838	CH-11348	CRSL	84874-S	CH-12234	NW	
8032064	CH08-14410	IVCO	81.54131.0001	CH-12953	MAN	82034441	ST-17103	NEWH	8385294	CH-12225	GRV	84877-S	CH-12980	NW	
8032066	ST08-14413	IVCO	81.8304.0055	CH-12385	MAN	8243K	CH-12345	CRSL	83893-N	PF-14090	NW	84878-S	CH-12278	NW	
8034304	ST12-15870	IVCO	810	CH-12839	CRSL	825562	CH10-11308	I-R	83893-N	PFM-14095	NW	84880-S	CH-12238	NW	
8040	CH-14211	CRSL	810 830 400 6+	CH-12242	MAN	82-56-032	CH05-11106	FORD	8400	CH-12262	OHSK	848924	CH06-11056	ATLSW	
80748274	CH-12278	NEWH	8100346	CH04-11675	FNWK	82-57-914	CH05-11106	FORD	84030107	CH-16294	NEWH	84894-S	ST-13410	NW	
808040-R1	CH-12272	CASEI	8100778	CH05-11106	FNWK	8273006	CH08-12243	KRNG	8403756	CH12-12251	YT	84902-S	CH-12867	NW	
8092438	ST-13530	IVCO	8101220	ST06-11109	FNWK	8273234	CH05-11467	KRNG	8406317	CH-12386	O&K	84905-S	ST-12226	NW	
8092439	CH-12385	IVCO	8103598	ST06-12048	FNWK	8273235	ST-13410	KRNG	8407839	CH10-12224	YT	84906-S	ST-13531	NW	
8092441	CH-12242	IVCO	8104273	ST-13530	FNWK	8273237	CH08-11288	KRNG	84198-92	CH12-12251	HOUG	84907-S	ST-13527	NW	
8092442	ST-13527	IVCO	81055040033	CH-12238	MAN	8273238	ST08-11316	KRNG	84285N	PF-15683	NW	84908-S	ST-13530	NW	
8092444	ST-13528	IVCO	8106840	ST-13531	IVCO	8273267	CH06-14733	KRNG	842PL	CH-12208	GLDS	84909-S	ST-13529	NW	
8092445	CH-12235	IVCO	81083040039	CH-12238	MAN	8283485	CH14-12245	CLS	84371	CH10-12224	DR/G	84911-S	CH06-12258	NW	
8092446	ST-13529	IVCO	81083040074	CH-14107	MAN	8293904	CH08-11288	VOLV	84611-S	CH05-12222	NW	84925-S	SC06-11252	NW	
81.08205.0005	CH-12235	MAN	81083040076	CH-14107	MAN	82981152	CH08-17365	NEWH	84655-S	CH14-13356	NW	84966-S	SC10-12395	NW	
81.08304.0023	CH-12238	MAN	81083040083	CH-14900	MAN	830	CH-12177	CRSL	84670-S	CH-12271	NW	84971-S	CH-12206	NW	
81.08304.0024	CH-12234	MAN	81-08304-0097	CH-14900	MAN	8319000050	SC-12274	KSBR	84671-S	CH-12272	NW	84975-S	CH-12177	NW	
81.08304.0028	CH-12232	MAN	81096473	CH-12286	EUC	8319009084	CH-12385	KSBR	84682-S	CH06-11295	NW	84978-S	CH-12213	NW	
81.08304.0029	CH-12234	MAN	8109774	CH-12386	IVCO	8319039104	CH12-12251	KSBR	84686-S	CH-12275	NW	84982-S	CH-12660	NW	
81.08304.0032	CH-16873	MAN	8113000200	CH04-11675	ROKI	8319039109	CH12-12251	KSBR	84698-S	CH-12283	NW	84983-S	CH-12385	NW	
81.08304.0036	CH-12242	MAN	81166609	CH-12177	TAMRO	831-905-86-09	CH-12235	KSBR	84699-S	CH-12826	NW	84987-S	CH-12204	NW	
81.08304.0038	CH-12278	MAN	812191802740	ST-13531	FAHR	831-908-51-02	CH-12242	KSBR	84700-S	CH-16873	NW	84988-S	PF-15680	NW	
81.08304.0040	CH-12235	MAN	8122408	CH-12387	IVCO	831-908-60-94	CH-16873	KSBR	84705-S	CH-12247	NW	84990-S	CH-12248	NW	
81.08304.0041	CH-12235	MAN	813923	CH12-11389	TOWM	8319095116	CH-12278	KSBR	84706-S	CH-12246	NW	84991-S	CH-12386	NW	
81.08304.0043	CH-12278	MAN	813957	SC12-11391	TOWM	8319098117	CH-16873	KSBR	84708-S	CH-12236	NW	84992-S	CH-12235	NW	
81.08304.0044	CH-12278	MAN	814256	SC10-11317	DYNAP	832046	CH14-12245	AMHO	84713-S	CH-12285	NW	84994-S	CH-12653	NW	
81.08304.0045	CH-12242	MAN	814257	CH10-11308	DYNAP	832047	SC14-12254	AMHO	84714-S	CH-12225	NW	84996-S	CH-12397	NW	
81.08304.0046	ST-13527	MAN	8143691	PF-15441	VOLV	8322121	CH-12215	FALLI	84718-S	CH-11020	NW	84999-S	CH-12242	NW	
81.08304.0048	CH-12235	MAN	8143691-7	PF-15441	VOLV	8322122	CH-12216	FALLI	84721-S	CH-12232	NW	8505-01	ST09-12265	PCLN	
81.08304.0049	CH-12385	MAN	8144430	PF-15441	VOLV	8322128	CH-12216	FALLI	84723-S	SC18-17232	NW	8505-61	CH12-11389	PCLN	
81.08304.0050	SC14-12254	MAN	814774	CH-12213	AKER	8322129	CH-12215	FALLI	84724-S	CH-11211	NW	8505-62	SC12-11391	PCLN	
81.08304.0051	CH14-12245	MAN	81721319	CH-12286	TAMRO	8322160	CH10-11308	BNFR	84730-S	CH-12752	NW	8505-68	CH-12273	PCLN	
81.08304.0053	CH-12386	MAN	81721449	ST09-12265	TAMRO	8322160	CH-12203	FIATH	84731-S	CH-12212	NW	8505-69	SC-12274	PCLN	
81.08304.0054	CH-12386	MAN	8183040040	CH-12235	MAN	8322161	SC10-11317	BNFR	84766-S	CH04-11675	NW	85225039	SC-12274	TAMRO	
81.08304.0055	CH-12385	MAN	81868102	PF-15701	NEWH	8322211	CH-12217	FIATH	848100069	CH06-11880	FAIEX	85352-1072	CH05-11106	KRNG	
81.08304.0057	CH-12235	MAN	81869555	ST-14715	NEWH	8322212	CH-12218	FIATH	848101065	CH08-11288	FAIEX	85352-1073	CH05-11106	KRNG	
81.08304.0058	SC-12252	MAN	81DB-9601-BA	CH12-11389	FORD	8322986	CH-12278	FALLI	848101081	CH06-11295	KOMD	853521198	CH08-11003	KRNG	
81.08304.0059	CH16-12253	MAN	81-SD-25	CH12-12251	MACK	834629	CH14-12245	AMHO	848101104	ST08-11316	FAIEX	85400646	CH05-14409	I-R	
81.08304.0060	CH-12235	MAN	820	AIR	SC-12270	DX	834635	SC14-12254	AMHO	848101105	ST08-11110	KMTS	85400679	CH07-14074	I-R
81.08304.0062	CH12-11389	MAN	82001780	ST-17092	NEWH	834639	CH16-12253	AMHO	848101113	CH05-11555	FAIEX	85400729	CH08-14410	I-R	
81.08304.0063	SC12-11391	MAN	82001820	ST-17103	NEWH	834644	SC-12252	AMHO	848101114	CH05-11106	FAIEX	8561046	CH08-11288	IVCO	
81.08304.0065	ST-13529	MAN	82003726	CH-14722	NEWH	835	AIR	CH14-12245	DX	848101116	ST05-11618	FAIEX	85632-009	CH-12269	VERMR

Number Finder



MFRS. NO.	OUR NO. MFR	MFRS. NO.	OUR NO. MFR	MFRS. NO.	OUR NO. MFR	MFRS. NO.	OUR NO. MFR	MFRS. NO.	OUR NO. MFR
8576344	CH12-12251 CLS	87290	CH-12260 CARQ	87927	CH-12269 CARQ	88561	CH-12286 CARQ	8994564	CH05-11467 GMC
85831809	SC10-12395 TAMRO	8729984	CH12-11389 CLS	87928	SC-12270 CARQ	88569	ST08-14413 CARQ	8994587	ST-12226 GMC
85832099	ST08-11316 TAMRO	8729998	CH-12262 CLS	87966	CH-12268 CARQ	88580	PF-14090 CARQ	8994589	CH06-11056 GMC
8584532	CH12-11389 CLS	87321	CH08-11288 CARQ	880271-M1	CH-12209 M-F	88580	PFM-14095 CARQ	8994619	CH-12282 GMC
858488	CH-15005 VOLV	87334	CH-12214 CARQ	88120	PF-15683 CARQ	88594	CH-12234 CARQ	8994635	ST06-11315 GMC
86.08304.4001	CH-12234 MAN	87335	CH-13156 CARQ	88133	PF-15684 CARQ	886017-C92	CH10-12224 CASEI	8994637	CH06-11295 GMC
86083044001	CH-12234 MHWK	87336	CH-13141 CARQ	88188	CH-12206 CARQ	88606	CH06-11295 CARQ	8994643	CH08-11288 GMC
8619828	CH06-12258 BOSS	87342	CH-12272 CARQ	88210	CH-12847 CARQ	88613	CH-13270 CARQ	8994649	CH-13141 GMC
8620140	CH14-12245 BOSS	873737-C91	CH12-11389 IHCH	8822160	CH-12203 FIATH	88625	CH08-11942 CARQ	8994710	CH10-12224 GMC
8620159	CH05-11106 BOSS	87378	CH-12207 CARQ	88263	ST05-14980 CARQ	8862651	SC12-11391 BOSS	8994720	CH-12260 GMC
8620167	CH06-12258 BOSS	874.08.0789	SC10-11317 KLBL	882681	CH-12262 WHITE	8863355	CH06-11295 BOSST	8994728	CH08-11003 GMC
8620204	CH08-11288 BOSS	874.08.0790	CH10-11308 KLBL	88270	CH04-11675 CARQ	88642	CH-12276 CARQ	8994729	CH08-12243 GMC
8620212	SC10-11317 BOSS	87489	CH05-11467 CARQ	88274	CH-12215 CARQ	88643	SC10-11317 CARQ	8994732	CH12-11389 GMC
8639028	CH06-14733 BOSS	87503	CH08-12221 CARQ	88294	CH-12091 CARQ	88652	CH07-14074 CARQ	8994736	CH-12273 GMC
86504143	ST-14343 NEWH	87505	CH-12209 CARQ	88313	CH-12397 CARQ	886544	CH05-11106 CLARK	8994737	CH-12273 GMC
86509128	CH-12235 FORD	87508	CH-12282 CARQ	88327	CH-12272 CARQ	88741	CH-12278 CARQ	8994740	CH14-12245 GMC
86509129	ST-13529 FORD	87518	CH06-14733 CARQ	88328	CH-12247 CARQ	887977-C91	CH12-12251 IHCH	8994742	CH-12269 GMC
86512355	ST08-12229 FIATH	87522	CH09-12244 CARQ	88330	CH-12285 CARQ	88852	CH-12289 CARQ	8994743	CH-12269 GMC
86512356	CH08-12228 FIATH	8752811	CH12-11389 CLS	88351	CH-12213 CARQ	88868	CH-11020 CARQ	8994744	CH10-11308 GMC
86512886	CH04-11675 FORD	8752811	CH12-11389 GRV	88352	CH-12403 CARQ	888686	CH-12262 WHITE	8994745	CH10-11308 GMC
86519866	CH05-15887 NEWH	87540	CH-12275 CARQ	88360	CH05-11106 CARQ	888686-H2	CH-12262 DMNDT	8994746	CH05-11106 GMC
86529569	CH-12790 TAMRO	8754231	CH14-12245 CLS	88375	ST08-11110 CARQ	889097	CH05-11106 CLARK	8994747	CH05-11106 GMC
86529587	CH08-12228 NEWH	87550	CH-12209 CARQ	88378	CH-12605 CARQ	889098	CH05-11106 CLARK	8994750	CH06-11038 GMC
865775	CH12-11389 BOSS	8755193	PF-15680 CLS	88407	ST-14715 CARQ	890991	CH-12262 CLARK	8994764	SC12-11391 GMC
8657795	CH12-11389 BOSS	8755193	PF-15680 GRV	88408	CH-12485 CARQ	891873	CH-12262 CLARK	8994765	SC12-11391 GMC
869 094 0013	CH21-17070 MTU	87595	PF-15677 CARQ	88414	CH-12248 CARQ	8935978	CH14-12245 CLS	8994766	SC10-11317 GMC
869 094 0430	CH-12385 MTU	87608	CH-12235 CARQ	88430	CH-12231 CARQ	896056	CH-12209 CLARK	8994767	SC10-11317 GMC
869065	CH12-11389 ATLAS	87609	ST-13529 CARQ	88466	CH08-12228 CARQ	896688	CH12-12251 WHITE	8994768	CH05-12222 GMC
869076	SC12-11391 ATLAS	87618	CH-12268 CARQ	88467	ST08-12229 CARQ	896688-H2	CH12-12251 DMNDT	8994770	SC14-12254 GMC
8690940	CH-12278 MTU	87630	CH-12177 CARQ	88487	CH08-12228 CARQ	896688-H2	CH12-12251 WHITE	8994772	SC-12274 GMC
8690940020	CH-12278 DMBZ	87631	CH06-11056 CARQ	88496	CH-12716 CARQ	8970415	CH14-12245 CLS	8994774	SC-12270 GMC
87045	CH-12210 CARQ	87632	ST-12226 CARQ	88498	CH-12491 CARQ	8-97042317-0	CH04-11675 ISZ	8994937	CH-12177 GMC
87046	CH-13150 CARQ	87653	CH06-12258 CARQ	88502	CH-14722 CARQ	897064	CH04-11675 CLARK	8994961	CH-12209 GMC
87047	CH-12208 CARQ	87656	CH14-13356 CARQ	88504	CH-14334 CARQ	8973286	CH12-11389 CLS	8994979	SC10-12395 GMC
87048	CH-13157 CARQ	87657	SC14-13357 CARQ	88510	CH-12225 CARQ	8975053	CH12-11389 CLS	8994985	ST06-11315 GMC
87119	CH12-11389 CARQ	87679	ST06-11315 CARQ	88515	CH-12386 CARQ	89811231	ST-13528 NEWH	8995167	CH-12268 GMC
87123	CH05-12222 CARQ	87710	CH-12839 CARQ	88517	ST-13410 CARQ	89835746	ST-17470 NEWH	8C-3047	SC14-12254 CAT
87133	PF-15684 CARQ	87764	CH-12262 CARQ	88522	ST08-11316 CARQ	8985294	CH-12225 CLS	8J-37-14629	CH05-11106 DAVS
87142	CH08-11003 CARQ	87769	ST-14343 CARQ	88525	ST-13531 CARQ	8985294	CH-12225 GRV	8M-8047	CH-12208 CAT
87208	CH14-12245 CARQ	8779594	CH10-11308 CLS	88526	CH06-11941 CARQ	8987765	CH09-12244 CLS	8N-5316	CH-12210 CAT
87209	SC14-12254 CARQ	87811	CH-12206 CARQ	88532	ST-13530 CARQ	8988242	CH08-11288 GRV	8N-5317	CH-12214 CAT
87225	CH-12273 CARQ	87868	CH08-11288 CARQ	88534	CH-12867 CARQ	8994210	CH08-12221 GMC	8N-5373	CH-12214 CAT
87226	SC-12274 CARQ	87878	CH-12249 CARQ	88537	CH08-12228 CARQ	8994238	CH-12268 GMC	8N-5389	CH-12208 CAT
87237	CH12-12251 CARQ	87890	CH-12262 CARQ	88538	ST08-12229 CARQ	8994494	CH06-14733 GMC	8N-5911	CH-12210 CAT
87238	CH21-17070 CARQ	87918	CH-14104 CARQ	88541	CH-12242 CARQ	8994516	CH14-13356 GMC	8N-6309	CH-12403 CAT
87239	SC21-17075 CARQ	87919	CH10-11308 CARQ	88546	CH-12232 CARQ	8994518	SC14-13357 GMC	8T-2405	CH05-11106 H-W
87258	CH18-17230 CARQ	87920	SC10-11317 CARQ	88547	CH-12283 CARQ	8994522	CH08-11288 GMC	8T-5600	CH12-11389 CAT
87259	SC18-17232 CARQ	87921	SC10-12395 CARQ	88554	CH-12385 CARQ	8994524	ST08-11316 GMC	8T-6305	CH08-11288 CAT
87276	CH05-11106 CARQ	87924	SC12-11391 CARQ	88560	ST09-12265 CARQ	8994542	CH-12847 GMC	8T7462	CH09-12244 CAT

Number Finder



MFRS. NO.	OUR NO. MFR	MFRS. NO.	OUR NO. MFR	MFRS. NO.	OUR NO. MFR	MFRS. NO.	OUR NO. MFR	MFRS. NO.	OUR NO. MFR
8T-8076	CH14-12245 CAT	9.23.416.17	CH-12278 SAVAR	9030537	CH-12262 GMC	91261-00700	CH05-11106 MTSB	92147353	CH06-14733 I-R
8U2601	CH09-12244 CAT	9.23.420.17	CH-12385 SAVAR	9030537	CH-12262 KW	9-126100700-C	CH05-11106 MTSB	92147453	CH06-14733 I-R
9 457 233 220	PF-15684 BSH	9.23.446.00	CH-12242 SAVAR	9030854	CH-12260 EUC	91261-10110	CH05-11106 MTSB	9215674	CH-12260 KW
9.20.267.17	CH-12215 SAVAR	9.23.446.17	CH-12242 SAVAR	9030854	CH-12260 KW	9130	CH-12215 CRSL	9218797	CH-12260 EUC
9.20.282.17	CH-13157 SAVAR	9.23.467.17	CH-12386 SAVAR	9030894	CH12-12251 EUC	9-14215-017-0	SC10-11317 ISZ	9218797	CH-12260 GMC
9.20.401.17	CH-12208 SAVAR	9.23.471.17	CH-12238 SAVAR	9030894	CH12-12251 GMC	9-14215034-0	SC14-12254 ISZ	922	SC-12274 AMPT
9.22.137.17	CH-11348 SAVAR	9.23.474.17	CH-12247 SAVAR	9033-AX1	CH08-12243 BKR	9-14215-046-1	CH14-12245 ISZ	9226	PF-15690 CRSL
9.22.266.17	CH-12215 SAVAR	9.23.475.17	CH-12246 SAVAR	9033-AX1	CH08-12243 OTIS	9-14215132-0	CH10-12224 ISZ	922630	CH-12177 DVDB
9.22.267.17	CH-12216 SAVAR	9.23.517.17	CH-12264 SAVAR	9033-AY1	CH05-11106 BKR	9-14215132-1	CH10-12224 ISZ	92266485	CH12-12251 I-R
9.22.861.17	CH-12177 SAVAR	9.23.518	ST-13529 SAVAR	9033-AY1	CH05-11106 OTIS	9-14215-140-2	CH12-12251 ISZ	92266519	CH12-11389 I-R
9.22.863.17	CH-12206 SAVAR	9.23.518.17	ST-13529 SAVAR	9034529	CH-12273 EUC	9-14215-153-1	CH10-11308 ISZ	92273705	CH14-12245 I-R
9.22.897.17	SC10-11317 SAVAR	9.23.524.17	CH-12282 SAVAR	9035368	SC-12274 EUC	9-14215-166-1	CH08-11288 ISZ	9231100577	CH-16689 KALMA
9.22.901.17	CH-12214 SAVAR	9.23.539	CH12-11343 SAVAR	9035428	SC-12274 EUC	9-14215-170-0	SC10-11317 ISZ	9231100578	SC-16290 KALMA
9.22.903.17	SC14-12254 SAVAR	9.23.539	CH-13477 SAVAR	9035866	CH-12266 EUC	9-14215175-0	CH10-12224 ISZ	92313000	CH-12273 FALLI
9.22.906.17	CH14-12245 SAVAR	9.23.676.17	CH-12231 SAVAR	9035988	CH-12266 EUC	9-14215183-0	CH08-11003 ISZ	9240849	SC-12274 EUC
9.22.941.17	CH-12262 SAVAR	9.23.677	ST-13527 SAVAR	9036278	SC-12274 EUC	9-14215184-0	CH10-11308 ISZ	924279C1	CH10-11308 IHCH
9.22.944.17	CH05-11106 SAVAR	9.23.711.17	CH-12278 SAVAR	9037346	SC-12274 EUC	9-14215-193-2	CH12-12251 ISZ	924280-C1	SC10-12395 CASEI
9.22.946.17	CH04-11675 SAVAR	9.23.843.17	CH-13763 SAVAR	9038349	SC21-17075 EUC	91461-00500	CH05-11106 MTSB	9247127	CH-12266 EUC
9.22.950.17	CH12-11389 SAVAR	9.27.026.17	CH-12208 SAVAR	9038350	CH21-17070 EUC	915613	CH12-12251 INSL	9247285	SC-12274 EUC
9.22.951.17	SC12-11391 SAVAR	90.80115.5196	CH-12234 MAN	9038407	CH-12269 EUC	91634337	SC-12252 I-R	924779-C1	CH06-11056 CASEI
9.23.002.17	PF-14090 SAVAR	900020	CH12-11389 HLMT	9038407	CH-12269 GMC	91634345	CH16-12253 I-R	924779-C2	CH06-11056 CASEI
9.23.002.17	PFM-14095 SAVAR	900136	SC10-11317 EDER	9038408	SC-12270 EUC	91672675	CH14-12245 I-R	9249091	CH-12266 EUC
9.23.021.17	CH-12207 SAVAR	900137	CH-12276 EDER	9038895	CH-12262 EUC	91672683	SC14-12254 I-R	9260261	CH05-11106 BOSS
9.23.026.17	CH-12208 SAVAR	900417	CH-12260 UNIT	9038898	CH12-12251 EUC	917275	ST-16487 O&K	9264	PF-15693 CRSL
9.23.029.17	CH-12209 SAVAR	900635	CH-12225 DON	9038898	CH12-12251 GMC	917276	CH-12231 O&K	926783-C1	CH14-12245 CASEI
9.23.032.17	CH-12210 SAVAR	900691	CH-12385 VOLV	9038899	CH-12273 EUC	9186100700	CH-12272 MTSB	926784-C1	SC14-12254 CASEI
9.23.033.17	CH-13150 SAVAR	9007585	ST08-12229 AVBA	9038899	CH-12273 GMC	919	SC-12270 AMPT	92686922	CH-12242 I-R
9.23.035.17	CH-13156 SAVAR	9007611	ST08-12229 AVBA	9038902	CH-12260 EUC	9191704	CH-12262 EUC	92686930	ST-13527 I-R
9.23.036.17	CH-13157 SAVAR	9007613	CH08-12228 AVBA	9038902	CH-12260 GMC	9191704	CH-12262 KW	92686948	CH-12235 I-R
9.23.041.17	CH-12260 SAVAR	9007613	CH08-12228 F-A	9049489	SC-12274 EUC	919704	CH-12262 KW	92686955	ST-13529 I-R
9.23.048.17	CH12-12251 SAVAR	9007690	CH10-11308 AVBA	9049489	SC-12274 GMC	920	CH-12269 AMPT	92740984	CH-12278 I-R
9.23.051.17	CH-12262 SAVAR	9007691	SC10-11317 AVBA	9049490	SC-12252 EUC	920007502	CH10-11117 FALLI	92740992	ST-13528 I-R
9.23.111.17	CH-12275 SAVAR	900785	ST08-12229 F-A	9053258	SC18-17232 EUC	920015933	CH08-11935 FALLI	92793025	CH08-14410 I-R
9.23.113.17	CH08-12221 SAVAR	9008	PF-15686 CRSL	905427-005	CH04-11675 VERMR	920015933	CH08-11935 IVCO	92867357	CH-13205 I-R
9.23.130.17	CH-12273 SAVAR	9009	CH-12953 CRSL	9059564	CH18-17230 EUC	92003490	CH-12262 I-R	92888718	CH-13115 I-R
9.23.131.17	SC-12274 SAVAR	901069	CH05-11106 DEMG	9059575	CH-12276 EUC	92035948	CH-12278 I-R	92889534	CH-13116 I-R
9.23.151.17	CH-12269 SAVAR	901157	CH-12266 UNIT	9059577	CH-12286 EUC	92035955	ST-13528 I-R	9292365	CH-12397 FALLI
9.23.169.17	CH-12839 SAVAR	901498-003	CH09-12244 VERMR	9062	PF-15683 CRSL	92055530	CH-12278 I-R	93 793 025	CH08-14410 I-R
9.23.211.17	CH-12249 SAVAR	901498-007	ST09-12265 VERMR	9065371	SC-12274 EUC	92058885	CH-12839 I-R	9-304-100001	CH14-12245 GRV
9.23.236.17	CH-12213 SAVAR	901515400	CH05-11106 YT	90801155191	CH-12238 BSS	9206065	CH-12260 EUC	9-304-100003	CH16-12253 GRV
9.23.237.17	CH-12660 SAVAR	901619	CH21-17070 UNIT	9083212	CH08-11288 FALLI	9206065	CH-12260 KW	9-304-100023	CH16-12253 GRV
9.23.243.17	CH-12091 SAVAR	901620	SC21-17075 UNIT	908946-M4	CH-12209 ECHR	920624	CH-12262 EUC	9-304-100068	SC12-11391 GRV
9.23.244.17	PF-15677 SAVAR	902199	ST-14787 DYNAP	91008551	CH14-12245 GMC	9206424	CH-12262 KW	9-304-100074	SC14-12254 GRV
9.23.245.17	PF-15680 SAVAR	902225300	CH05-11106 YT	91021394	CH16-12253 GMC	92079425	CH10-11308 I-R	9-304-100077	CH06-14733 GRV
9.23.322.17	PF-15684 SAVAR	9028234	CH-12262 EUC	91107151	CH-12857 GMC	920920110	CH-16294 VHOL	9-304-100084	ST08-11316 GRV
9.23.332.17	ST08-11316 SAVAR	9028636	CH-12262 EUC	91107151	CH-12857 GMC	920K	PF-15680 CRSL	9-304-100091	CH05-11467 GRV
9.23.362.17	CH10-11308 SAVAR	903011790	CH05-11106 SXB	91112964	CH-13090 AWD	921	CH-12213 CRSL	9-304-100099	SC10-11317 GRV
9.23.363.17	CH08-11288 SAVAR	903053	CH-12262 EUC	91112964	CH-13090 GMC	92117431	CH08-11288 I-R	9-304-100113	CH04-11675 GRV
9.23.404.17	CH-12235 SAVAR	9030537	CH-12262 EUC	9120014	CH04-11675 BDGER	92124213	CH-12285 I-R	9-304-100123	CH16-12253 GRV

Number Finder



MFRS. NO.	OUR NO. MFR	MFRS. NO.	OUR NO. MFR	MFRS. NO.	OUR NO. MFR	MFRS. NO.	OUR NO. MFR	MFRS. NO.	OUR NO. MFR
9-304-10091	CH05-11467 GRV	93489	CH05-11467 AMPT	94188	CH-12206 AMPT	9451160011	SC14-12254 BSH	9474-9001	CH-12798 DAEW
93045	CH-12210 AMPT	93503	CH08-12221 AMPT	942084.0	ST-13531 CLAS	9451160012	CH-12242 BSH	9474-9002	SC10-12395 DAEW
93046	CH-13150 AMPT	93505	CH-12209 AMPT	94210	CH-12847 AMPT	9451160014	CH-12247 BSH	948313	CH10-11308 CLARK
93047	CH-12208 AMPT	93508	CH-12282 AMPT	94263	ST05-14980 AMPT	9451160020	CH-12091 BSH	94852	CH-12289 AMPT
93048	CH-13157 AMPT	93518	CH06-14733 AMPT	94270	CH04-11675 AMPT	9451160022	CH-12285 BSH	94868	CH-11020 AMPT
9304811	CH-12214 PURO	93522	CH09-12244 AMPT	94274	CH-12215 AMPT	9451160024	CH-12225 BSH	949363	SC-12252 CLARK
9-304-990010	CH-12235 GRV	93540	CH-12275 AMPT	94275	CH-12216 AMPT	9451160028	CH12-12251 BSH	949524	SC-12274 CLARK
9-304-990030	CH14-12245 GRV	93550	CH-12209 AMPT	94278-6	SC-12252 ERF	9451160030	CH-16873 BSH	949525	CH-12273 CLARK
9-304-990031	SC14-12254 GRV	93595	PF-15677 AMPT	94279-2	CH16-12253 ERF	9451160036	CH-12250 BSH	9508	CH-12250 CRSL
9-304-990050	ST-13527 GRV	93608	CH-12235 AMPT	94294	CH-12091 AMPT	9451160036	CH-16874 BSH	9508	CH-16874 CRSL
9-304-990051	CH-12242 GRV	93609	ST-13529 AMPT	94304-2	CH-13050 ERF	9451160038	CH-12231 BSH	9510	CH-12385 CRSL
9-304-99030	CH14-12245 GRV	93618	CH-12268 AMPT	94313	CH-12397 AMPT	9451160042	CH-12232 BSH	9516K	CH08-12228 CRSL
93119	CH12-11389 AMPT	93630	CH-12177 AMPT	94327	CH-12272 AMPT	9451160044	CH-12236 BSH	952	CH-12660 CRSL
93123	CH05-12222 AMPT	93631	CH06-11056 AMPT	94328	CH-12247 AMPT	9451160050	CH-12660 BSH	9522	CH-12235 CRSL
93133	PF-15684 AMPT	93632	ST-12226 AMPT	94330	CH-12285 AMPT	9451160052	CH-12264 BSH	9523	CH-16873 CRSL
93142	CH08-11003 AMPT	93653	CH06-12258 AMPT	94351	CH-12213 AMPT	9451160056	CH-12234 BSH	9527K	CH10-11308 CRSL
93152006	CH-12247 GMC	93656	CH14-13356 AMPT	94352	CH-12403 AMPT	9451160060	CH-12238 BSH	9529	CH-12980 CRSL
93152016	CH-12225 GMC	93657	SC14-13357 AMPT	94360	CH05-11106 AMPT	9451160060	CH-12242 BSH	9532	CH-12397 CRSL
93152017	CH-12285 GMC	93679	ST06-11315 AMPT	9-437-100135	CH12-11389 GRV	94515	CH-12386 AMPT	9533	CH-12238 CRSL
93152039	CH-12247 GMC	93710	CH-12839 AMPT	9-437-100136	SC12-11391 GRV	94517	ST-13410 AMPT	9550	CH-12248 CRSL
93152088	ST08-11316 GMC	93764	CH-12262 AMPT	9-437-100309	CH09-12244 GRV	94522	ST08-11316 AMPT	9551	CH-12386 CRSL
93152216	CH-12091 GMC	93769	ST-14343 AMPT	94375	ST08-11110 AMPT	94525	ST-13531 AMPT	9552	CH-12214 CRSL
93152231	CH-12246 GMC	9377816	SC14-12254 EUC	94378	CH-12605 AMPT	94526	CH06-11941 AMPT	9553	CH-12208 CRSL
93152232	CH-12236 GMC	93811	CH-12206 AMPT	9-437-990005	SC-12252 GRV	94532	ST-13530 AMPT	9555	CH-12826 CRSL
93152236	CH-12826 GMC	93868	CH08-11288 AMPT	944	CH12-11389 CRSL	94537	CH08-12228 AMPT	9556	CH-12242 CRSL
93152303	CH-12264 GMC	93878	CH-12249 AMPT	94407	ST-14715 AMPT	94538	ST08-12229 AMPT	9560K	CH08-12221 CRSL
93152421	CH-11211 GMC	93890	CH-12262 AMPT	94408	CH-12485 AMPT	94541	CH-12242 AMPT	9561	CH-12231 CRSL
93191542	CH-13835 I-R	939	CH-14104 AMPT	94414	CH-12248 AMPT	94546	CH-12232 AMPT	956571	CH06-11295 DEMG
93208	CH14-12245 AMPT	9391461	CH14-12245 GMC	94430	CH-12231 AMPT	94547	CH-12283 AMPT	9572	CH-12273 CRSL
93209	SC14-12254 AMPT	93918	CH-14104 AMPT	944404	CH14-12245 CLARK	94554	CH-12385 AMPT	9573	SC-12274 CRSL
932195	CH04-14412 TORO	93919	CH10-11308 AMPT	94466	CH08-12228 AMPT	94560	ST09-12265 AMPT	9576	CH-11211 CRSL
93225	CH-12273 AMPT	9391941	CH06-11295 EUC	94467	ST08-12229 AMPT	94561	CH-12286 AMPT	9577	CH-12213 CRSL
93226	SC-12274 AMPT	93920	SC10-11317 AMPT	94487	CH08-12228 AMPT	94569	ST08-14413 AMPT	9580	CH-13156 CRSL
93237	CH12-12251 AMPT	93924	SC12-11391 AMPT	94496	CH-12716 AMPT	9457232360	CH-12213 BSH	9586	CH-13157 CRSL
93238	CH21-17070 AMPT	93927	CH-12269 AMPT	94498	CH-12491 AMPT	9457233670	CH-12250 BSH	9587	CH-12289 CRSL
93239	SC21-17075 AMPT	93928	SC-12270 AMPT	94502	CH-14722 AMPT	9457233670	CH-16874 BSH	9588	CH-12207 CRSL
93258	CH18-17230 AMPT	9394161	CH14-12245 EUC	94504	CH-14334 AMPT	94580	PF-14090 AMPT	958C	CH04-11675 AMC
93259	SC18-17232 AMPT	9395884	CH-12262 EUC	945059	CH12-12251 CLARK	94580	PFM-14095 AMPT	9590	CH-12752 CRSL
93276	CH05-11106 AMPT	9395885	CH-12260 EUC	945059	CH12-12251 CLTER	94594	CH-12234 AMPT	9591	CH-12247 CRSL
93290	CH-12260 AMPT	93966	CH-12268 AMPT	9450993	CH12-12251 TECA	94606	CH06-11295 AMPT	9592	CH-12283 CRSL
93321	CH08-11288 AMPT	9398482	CH14-12245 EUC	9450995	CH05-11106 TECA	94613	CH-13270 AMPT	9595	CH-12867 CRSL
93334	CH-12214 AMPT	9398483	SC14-12254 EUC	94510	CH-12225 AMPT	94625	CH08-11942 AMPT	9597K	CH06-12258 CRSL
93335	CH-13156 AMPT	940-084	ST-13531 CLAS	9451160001	CH-12385 BSH	946352	SC12-11391 CAT	9599	CH-12781 CRSL
93336	CH-13141 AMPT	941070	CH04-11675 CRRER	9451160003	CH12-11389 BSH	94642	CH-12276 AMPT	960243	CH14-12245 CLARK
933360	CH-12231 O&K	941078	CH04-11675 FRGK	9451160004	CH-12235 BSH	94643	SC10-11317 AMPT	961000	CH09-12244 CLARK
93342	CH-12272 AMPT	94120	PF-15683 AMPT	9451160005	CH14-12245 BSH	94652	CH07-14074 AMPT	961001	ST09-12265 CLARK
933688	CH12-11389 CLARK	94133	PF-15684 AMPT	9451160008	CH-12386 BSH	946847	CH14-12245 CLARK	961161	SC-12274 CLARK
933689	SC12-11391 CLARK	9-414-100884	CH04-11675 GRV	9451160009	CH05-11106 BSH	946897	CH14-12245 CLARK	9611K	CH06-11295 CRSL
93378	CH-12207 AMPT	9-414-100912	CH-12091 GRV	9451160010	CH-12248 BSH	94741	CH-12278 AMPT	9613	ST06-11315 CRSL

Number Finder



MFRS. NO.	OUR NO. MFR	MFRS. NO.	OUR NO. MFR	MFRS. NO.	OUR NO. MFR	MFRS. NO.	OUR NO. MFR	MFRS. NO.	OUR NO. MFR
9615	CH-12225 CRSL	9733K	CH-13270 CRSL	9839331	CH05-11106 FNWK	99737	CH12-11389 KOMD	A1019C	CH-12283 AC
9617	SC12-11391 CRSL	9735	ST06-12048 CRSL	9839331	CH05-11106 LINDE	99739	SC12-11391 DR/G	A101C	ST08-11110 AC
9618	ST08-11316 CRSL	9739K	CH-13811 CRSL	985	CH-12275 AMPT	99739	SC12-11391 KOMD	A1023C	CH-12213 AC
9623788	CH14-12245 ALLIC	9742	CH-12234 CRSL	9865	CH05-11106 MNTO	9974137	CH-12212 GMC	A1026C	CH-12204 AC
962K	CH05-11106 CRSL	9745	ST-13529 CRSL	988 633	CH-12273 DEMG	9974646	CH10-11308 GMC	A1028C	CH-12248 AC
9630	CH-12264 CRSL	9746-444	CH-12242 FAUN	988 634	SC-12274 DEMG	9974648	SC10-11317 GMC	A1029C	CH-12386 AC
9631	CH-12232 CRSL	9748	ST-16880 CRSL	988/00031	CH-12653 JCB	9974649	CH09-12244 GMC	A1030C	CH-12235 AC
9635	SC10-11317 CRSL	9749	CH-14107 CRSL	988575	CH-12285 DEMG	9974668	CH-12208 GMC	A1032C	CH-12653 AC
9638	CH-12276 CRSL	9750	ST-13528 CRSL	988585	CH-12385 DEMG	9974703	CH-12213 GMC	A1033C	CH-12397 AC
9640	SC14-12254 CRSL	9751	CH-12282 CRSL	988595	ST-13531 DEMG	9977-G	CH-12260 OHSK	A1035C	CH-12242 AC
964013	CH-12386 DEMG	976	CH05-11106 AMPT	988596	CH-12235 DEMG	997K	CH08-11288 CRSL	A1036C	CH-12215 AC
9647	CH-12278 CRSL	97611-005	CH06-14733 VERMR	988673	CH-12278 DEMG	998	CH-12249 CRSL	A1037C	CH-12216 AC
9648	ST-13527 CRSL	9765	CH-12825 CRSL	988674	ST-13528 DEMG	9C-3-107	CH08-12243 MTRC	A1038C	CH-12249 AC
9649	ST-13530 CRSL	9766	CH-12236 CRSL	988740	ST-13530 DEMG	9L-0699	CH-12214 CAT	A1042C	CH-12231 AC
964K	CH12-12251 CRSL	9776	ST-14787 CRSL	988765	ST-13529 DEMG	9M-1827	CH-12214 CAT	A1043C	CH-12091 AC
965	CH14-12245 CRSL	9779	CH-13185 CRSL	988766	CH-12242 DEMG	9M-3-21	CH-12260 MTRC	A1045C	CH08-12228 AC
9650	ST-13531 CRSL	977K	CH08-11288 CRSL	988767	ST-13527 DEMG	9S9972	CH-13141 NW	A1056C	CH-12867 AC
9652	CH-12210 CRSL	9783	CH08-17365 CRSL	989573-R91	CH-12262 IHCH	9S-9972	CH-13141 CAT	A10578R	CH-12660 AC
9653	CH-13150 CRSL	9784	ST08-14413 CRSL	990.00.19.013	CH-12235 SDP	9Y-6803	SC-12252 CAT	A1057C	ST-13410 AC
9654K	CH09-12244 CRSL	9795	CH-15294 CRSL	990.14.19.003	CH-12278 SDP	9Y-6804	SC14-12254 CAT	A10706-G1	CH04-11675 EZGO
9655	ST09-12265 CRSL	9796	CH-12507 CRSL	99000190075	CH-12242 SDP	9Y-6805	SC12-11391 CAT	A1072C	PF-14090 AC
9659	CH-12285 CRSL	9799	CH05-14409 CRSL	99000190701	CH-12385 SDP	9Y-6806	SC10-11317 CAT	A1072C	PFM-14095 AC
9661	CH-13050 CRSL	98026633	CH-12242 MNGLE	99000190702	CH-12242 SDP	9Y-6807	ST-13410 CAT	A-108	PF-15680 WIX
966360	CH-12231 O&K	98029974	ST-13527 MNGLE	99012190030	ST-13529 SDP	9Y-6817	CH06-11056 CAT	A1086C	CH-12247 AC
9664	CH-12857 CRSL	98039890	CH-12278 MNGLE	99012190037	CH-12235 SDP	9Y-6821	ST-12226 CAT	A1089C	PF-15684 AC
9665	ST-16487 CRSL	98039927	CH-12235 MNGLE	99012190137	CH-12235 SDP	9Y-6823	ST08-11110 CAT	A-11	CH-12206 WIX
966538	CH-12266 CLARK	98039928	ST-13529 MNGLE	99012190196	ST-13527 SDP	9Y-6826	CH-12209 CAT	A11042	CH-12953 PURO
966538	CH-12266 VME	98041118	ST-13528 MNGLE	99012190701	CH-12242 SDP	9Y-6828	CH14-12245 CAT	A1117C	CH-12272 AC
9667	ST-16488 CRSL	981	CH08-12221 AMPT	99012190705	CH-12235 SDP	9Y-6833	CH-12262 CAT	A-11569	CH08-12243 ELGS
9670	CH-12809 CRSL	9811231	ST-13528 NEWH	991	CH12-12251 AMPT	9Y6834	CH12-12251 CAT	A-116	CH-12235 WIX
9673	CH-12491 CRSL	9819406	CH05-11106 OM	991.12.19.003	ST-13529 SDP	9Y-6836	CH18-17230 CAT	A1185C	CH-12403 AC
9674	CH-12485 CRSL	98262/5025	CH14-12245 CMPR	991.12.19.070	CH-12235 SDP	9Y-6839	CH05-11106 CAT	A12102	CH-12249 PURO
9681K	CH06-11056 CRSL	983	CH08-11288 AMPT	99100307	CH-12225 ALLIC	9Y-6842	CH06-14733 CAT	A-122	CH12-12251 WIX
9682	ST-12226 CRSL	983 9020	ST-13531 FNWK	99114190025	ST-13528 SDP	9Y-6843	CH10-11308 CAT	A-123	CH-12262 WIX
969	CH-12653 CRSL	983 9020	ST-13531 LINDE	991240800	SC10-12395 SMSUN	9Y-6846	CH05-11467 CAT	A-124	CH-12653 WIX
9702158	CH06-14733 NEWH	9831604	CH-12385 FNWK	991245700	CH12-11389 SMSUN	9Y-6853	CH-12605 CAT	A-130	CH-12260 WIX
9705K	CH06-11941 CRSL	9831604	CH-12385 GLDNR	991245800	SC12-11391 SMSUN	9Y-7802	SC-12270 CAT	A13192	PF-15683 PURO
9706-1483	CH-12839 ATCO	9831604	CH-12385 LINDE	99131/2	CH-12235 ERF	9Y-7805	SC12-11391 CAT	A-133	CH-12266 WIX
971217	CH05-11106 CAT	9832046	CH14-12245 CLVL	992	CH-12212 CRSL	9Y-7808	CH12-11389 CAT	A13310	CH-12206 PURO
971217	CH05-11106 TOWM	9832047	SC14-12254 CLVL	9927506	CH-12284 FALLI	9Y-7810	CH-12269 CAT	A13316774	CH08-14410 CMPR
971310	CH-12209 TOWM	9839012	CH-12397 FNWK	9933276	CH14-12245 VHOL	9Y-7811	CH14-12245 CAT	A13346	CH-12177 PURO
9714	CH-12387 CRSL	9839012	CH-12397 LINDE	993608	CH12-11389 CLARK	9Y-7813	CH08-11288 CAT	A13368674	CH-16294 CMPR
971426	CH04-11675 TOWM	9839014	CH-12231 FNWK	993609	SC12-11391 CLARK	9Y-7814	CH09-12244 CAT	A-137	CH-12212 RYCO
9715	CH-13090 CRSL	9839014	CH-12231 LINDE	993688	CH12-11389 CLARK	A001 094 79 0	CH-12235 DMBZ	A-138	CH-12249 RYCO
9722K	CH-12770 CRSL	9839015	CH-12386 FNWK	993689	SC12-11391 CLARK	A08505-28	CH16-12253 PCLN	A-139	CH-12397 WIX
9724	ST-14343 CRSL	9839015	CH-12386 LINDE	996	CH10-11308 AMPT	A-10	CH-12839 WIX	A-141041	CH05-11106 CASE
9729	ST-16876 CRSL	9839016	ST-16488 FNWK	99701499695	CH-12235 TDANO	A1003C	CH-12278 AC	A-144	CH-12249 WIX
973 879 73	CH-12345 DEMG	9839019	CH-12285 FNWK	99708406317	CH-12980 TDANO	A10062A	CH-12213 AC	A-146	SC14-12254 WIX
9732K	CH08-11935 CRSL	9839019	CH-12285 LINDE	99737	CH12-11389 DR/G	A10062R	CH-12213 AC	A-148	CH-12212 WIX

Number Finder



MFRS. NO.	OUR NO. MFR	MFRS. NO.	OUR NO. MFR	MFRS. NO.	OUR NO. MFR	MFRS. NO.	OUR NO. MFR	MFRS. NO.	OUR NO. MFR
A-149	CH08-11288 WIX	A2276	CH-12091 FILT	A2516AL	CH-12275 FILT	A42114	CH-12212 PURO	A517	PF-15684 PRFX
A-150	CH-12231 WIX	A2289	CH05-11106 FILT	A2525	CH-12246 FILT	A424C	SC-12274 AC	A52052	CH-13157 PURO
A-152	CH-12385 WIX	A2289AL	CH05-11106 FILT	A2527	CH-12653 FILT	A424CL	SC-12274 AC	A52053	CH-13156 PURO
A1533C	CH-12282 AC	A2301	CH-12216 FILT	A255C	CH-11211 AC	A42896	ST-12226 PURO	A52199	SC-12270 PURO
A-154	CH-12660 WIX	A2302	CH-12215 FILT	A256C	CH-11020 AC	A428C	CH14-12245 AC	A522	CH-12204 TCNC
A1554C	ST06-12048 AC	A2306	CH-12212 FILT	A-26	CH-11348 RYCO	A43156	ST-14343 PURO	A52220	CH12-11389 PURO
A-156	CH-12246 WIX	A2312	CH12-12251 FILT	A260C	CH-12225 AC	A43176	CH-12272 PURO	A52266	SC12-11391 PURO
A1565C	CH-12485 AC	A-23180-14	CH08-12243 P-M	A-264	CH-12091 RYCO	A43332	CH-12209 PURO	A524	CH-12225 TCNC
A-157	CH-12209 WIX	A-23180-18	CH12-12251 P-M	A265C	CH-12260 AC	A43656	CH-12269 DROT	A525C	CH-12275 AC
A1581C	CH08-12228 AC	A-23180-23	CH08-12243 P-M	A266C	CH-13156 AC	A-43656	CH16-12253 CASE	A526	CH-12091 TCNC
A-159	SC12-11391 WIX	A-23180-35	CH-12262 P-M	A27050	PF-15693 PURO	A-43657	SC-12270 CASE	A527	ST08-12229 TCNC
A1592C	CH06-11941 AC	A2319	CH-12209 FILT	A2770	CH10-12224 MP	A436576	CH-12269 DROT	A527C	CH04-11675 AC
A-160	CH-12386 WIX	A-232-1	CH08-12243 AMHO	A-2770S	CH10-12224 NPON	A-44	PF-15683 SUNO	A528	CH-13150 TCNC
A-161	CH-12242 WIX	A2336	CH-12214 FILT	A2771	CH-12273 MP	A443C	SC14-12254 AC	A529	CH08-12228 TCNC
A-162	CH-12246 WIX	A2338	CH-13156 FILT	A27758	CH-12397 PURO	A44548	CH-12403 PURO	A52928	CH-13141 PURO
A164	CH12-11343 TCNC	A23465	PF-15684 PURO	A287	CH-15300 PRFX	A445C	CH-12269 AC	A529C	CH08-11288 AC
A164	CH-13477 TCNC	A2359	CH14-12245 FILT	A288C	CH-13150 AC	A445CL	CH-12269 AC	A530	CH-12214 TCNC
A-166	CH-12213 WIX	A-236	CH-12209 RYCO	A290C	CH-13157 AC	A446C	SC-12270 AC	A53152	CH06-11056 PURO
A-168	CH-12264 WIX	A2369	CH12-11389 FILT	A2950436	CH-17512 CMPR	A456C	CH-12260 AC	A53175	CH-12271 PURO
A-173290	CH06-14733 CASE	A2402	CH-12385 FILT	A296C	CH12-12251 AC	A457C	CH05-12222 AC	A532	CH-12208 TCNC
A184C	CH-12262 AC	A2407	SC14-12254 FILT	A297C	CH05-11106 AC	A457CL	CH05-12222 AC	A534	CH-13157 TCNC
A-20	CH-12209 RYCO	A2411	CH12-11389 FILT	A297CL	CH05-11106 AC	A462C	SC12-11391 AC	A53511	ST08-11110 PURO
A2009	CH-11348 FILT	A2412	CH10-11308 FILT	A299CL	CH08-11003 AC	A462CL	SC12-11391 AC	A53516	ST-13410 PURO
A-201	CH-12177 RYCO	A2418	CH-12250 FILT	A29C	CH-12289 AC	A473	CH-13939 PRFX	A536	CH-13156 TCNC
A2033	CH-12250 HRMO	A2418	CH-16874 FILT	A301CL	CH10-12224 AC	A475C	CH10-11308 AC	A537	CH12-12251 PRFX
A2033	CH-16874 HRMO	A2426	SC12-11391 FILT	A303	PF-15690 TCNC	A475CL	CH10-11308 AC	A538	CH-12210 TCNC
A2067	CH-11348 HRMO	A2427	CH-12386 FILT	A303C	CH-12209 AC	A476C	SC10-11317 AC	A540	CH05-11106 PRFX
A206C	CH-12262 AC	A2428	CH-12248 FILT	A304	PF-15693 TCNC	A476CL	SC10-11317 AC	A540	CH-12235 TCNC
A207C	CH-12208 AC	A2430	SC-12274 FILT	A-308	CH-12215 RYCO	A-48	CH-12839 RYCO	A541	ST-13529 TCNC
A2084	PF-15684 HRMO	A2431	CH-12273 FILT	A30890	CH-12262 PURO	A480	CH05-11106 TCNC	A542	CH14-12245 PRFX
A2085	CH-12385 HRMO	A2432	CH-12225 FILT	A-32	CH-11348 WIX	A481	CH-14387 TCNC	A542	CH-12385 TCNC
A208C	CH-12210 AC	A2434	CH-12242 FILT	A32238	CH05-12222 PURO	A482	SC14-12254 TCNC	A543	CH12-11389 PRFX
A209	CH-12236 PRFX	A2436	CH-12213 FILT	A34536	CH-12091 PURO	A488	CH-12268 TCNC	A544	CH16-12253 PRFX
A-209	CH-12091 RYCO	A2437	CH-12660 FILT	A-35	CH-12206 RYCO	A491	ST-13530 TCNC	A544	CH-12213 TCNC
A2096	CH-12206 FILT	A2438	CH-12826 FILT	A352	CH10-12224 VIC	A493	ST-13531 TCNC	A545	CH06-11295 PRFX
A2096/121	CH-12206 FILT	A2442	CH-12235 FILT	A353	CH10-11308 VIC	A-49329	CH08-12243 DAVEY	A545	CH-12266 TCNC
A209C	CH-12214 AC	A2448	CH-12232 FILT	A366	CH14-12245 VIC	A49378	CH-12207 PURO	A546	CH08-11288 LBF
A210C	CH-12207 AC	A2464	ST06-11315 FILT	A367	SC14-12254 VIC	A494	CH-12231 TCNC	A546	CH08-11288 PRFX
A2123	CH-12262 FILT	A2465	CH08-11288 FILT	A396	PF-15684 TCNC	A495	ST-13527 TCNC	A546	CH12-11389 TCNC
A2178	CH-12262 FILT	A2466	ST08-11316 FILT	A40015	PF-14090 PURO	A497	CH-12809 TCNC	A548	CH-12660 TCNC
A2201	CH-12249 FILT	A2467	CH-12231 FILT	A40015	PFM-14095 PURO	A498	SC12-11391 TCNC	A549C	CH-14104 AC
A22011	CH04-11675 PURO	A2477	CH04-11675 FILT	A408C	CH12-11389 AC	A5004	CH-12397 TCNC	A-55	CH-12177 WIX
A-221-1	CH05-11106 AMHO	A2480	CH-16873 FILT	A417CL	CH-12273 AC	A5008340004	CH09-12244 MAN	A550	SC14-12254 PRFX
A2217	CH-12207 FILT	A2484	CH-12271 FILT	A-42	PF-15684 SUNO	A501	CH-12278 TCNC	A550	CH-16873 TCNC
A2219	CH-12839 FILT	A2485	CH-12285 FILT	A42019	CH05-11106 PURO	A506	CH-12216 TCNC	A550C	CH06-14733 AC
A2221	CH-12208 FILT	A2494	CH-12272 FILT	A42029	CH-12209 PURO	A508	CH-12215 TCNC	A551	SC12-11391 PRFX
A2222	CH-13157 FILT	A-249753	CH05-11106 KLR	A42039	CH08-12221 PURO	A-50991	CH04-11675 OTIS	A552	ST08-11316 PRFX
A2233	CH-12210 FILT	A2498	CH08-12221 FILT	A42051	CH-12275 PURO	A510	CH12-11389 TCNC	A-55203	CH05-11106 CASE
A2234	CH-13150 FILT	A2513AL	CH09-12244 FILT	A42073	CH12-12251 PURO	A511	CH-12276 TCNC	A556	CH14-12245 TCNC

Number Finder



MFRS. NO.	OUR NO. MFR	MFRS. NO.	OUR NO. MFR	MFRS. NO.	OUR NO. MFR	MFRS. NO.	OUR NO. MFR	MFRS. NO.	OUR NO. MFR
A557	CH-12980 TCNC	A620C	CH06-11056 AC	A674C	CH08-11288 AC	A743	CH-14380 TCNC	A830X9601AC	CH09-12244 FORD
A558S	CH12-12251 VIC	A62125	CH-12260 PURO	A677C	CH-13141 AC	A744	CH08-12243 HRMO	A830X9601AD	CH-12232 FORD
A559C	CH08-12221 AC	A62200	SC14-12254 PURO	A-68	PF-15683 ATLAS	A751C	PF-15684 AC	A830X9601AE	CH-12385 FORD
A5619A	CH12-11389 MP	A62202	CH-12269 PURO	A683	SC12-11391 LBF	A752	CH-12276 TCNC	A830X9601AG	CH-12213 FORD
A5619B	SC12-11391 MP	A62204	CH10-11308 PURO	A685C	SC10-12395 AC	A753	CH-12247 TCNC	A830X9601AJ	CH-12242 FORD
A562	CH-12242 TCNC	A62206	SC-12274 PURO	A692	CH-12262 LBF	A758	CH-12387 TCNC	A830X9601AK	CH-12248 FORD
A5620B	SC14-12254 MP	A62221	CH14-12245 PURO	A69334	CH-12214 PURO	A759	CH-12213 HRMO	A830X9601AL	CH12-12251 FORD
A564	CH12-11389 VIC	A62222	CH-12273 PURO	A698	CH12-12251 LBF	A-76	CH-12177 WIX	A830X9601AM	CH-16873 FORD
A565	CH-14104 TCNC	A626	CH-12177 HRMO	A700	CH-12283 TCNC	A760X-9601-C	CH-11348 FORD	A830X9601AN	CH-12235 FORD
A565	SC12-11391 VIC	A62973	CH05-11467 PURO	A70014	PF-15677 PURO	A761	CH-12278 TCNC	A830X9601AR	CH-12238 FORD
A566	CH04-11675 TCNC	A62974	CH06-14733 PURO	A700X-9601-A	CH-11348 FORD	A764	CH-12286 TCNC	A830X9601AS	CH-12660 FORD
A570	CH05-12222 TCNC	A63028	CH09-12244 PURO	A701	CH-12273 LBF	A765	CH-12825 TCNC	A830X9601AU	CH-12264 FORD
A572	CH06-11295 TCNC	A63029	ST09-12265 PURO	A701	CH-12236 TCNC	A766	CH-14107 TCNC	A830X9601BA	CH-12247 FORD
A574	ST06-11315 TCNC	A63031	ST06-11315 PURO	A702	SC-12274 LBF	A767	ST09-12265 TCNC	A830X9601BB	CH-12246 FORD
A574C	CH14-13356 AC	A63101	ST-13531 PURO	A702	CH-11211 TCNC	A770	CH-13763 TCNC	A830X9601BD	CH14-12245 FORD
A575C	SC14-13357 AC	A63102	ST-13527 PURO	A702C	PF-15677 AC	A774	CH-12282 TCNC	A830X9601BE	CH-12278 FORD
A576	CH08-12221 TCNC	A63157	SC10-11317 PURO	A703	PF-15680 HRMO	A780X-9601-A	CH12-11389 FORD	A830X9601BF	CH-12283 FORD
A-58	CH-12213 WIX	A631C	CH-12177 AC	A704	CH-13520 TCNC	A780X-9601-C	CH-12397 FORD	A830X9601BG	CH-11211 FORD
A580	CH08-11288 TCNC	A63314	SC10-12395 PURO	A706	CH-13510 TCNC	A780XX-9601-	CH12-11389 FORD	A830X9601BK	PF-15680 FORD
A58047	CH-12208 PURO	A63393	CH08-11288 PURO	A711	CH14-12245 LBF	A783	SC-12270 LBF	A830X9601BS	CH-12231 FORD
A581	CH08-11935 TCNC	A634	CH-11348 HRMO	A712	CH-12485 TCNC	A784	CH-12177 PRFX	A830X9601BU	CH08-11288 FORD
A582	ST08-11316 TCNC	A634	CH-12213 LBF	A714	CH-12491 TCNC	A785	CH-12262 HRMO	A830X9601CA	CH-12980 FORD
A585	CH06-11056 TCNC	A63438	PF-14090 PURO	A717	CH09-12244 TCNC	A786	CH-12660 PRFX	A830X9601CB	CH-12232 FORD
A587	ST-12226 TCNC	A63438	PFM-14095 PURO	A720	CH12-11389 HRMO	A787	CH-12209 PRFX	A830X9601CC	CH-12385 FORD
A587C	CH08-11288 AC	A63459	ST08-11316 PURO	A720	CH05-11106 LBF	A791	CH-12250 PRFX	A830X9601CE	CH-12213 FORD
A588C	ST08-11316 AC	A63519	CH-12385 PURO	A720	CH-12248 TCNC	A791	CH-16874 PRFX	A830X9601CG	CH-12242 FORD
A589	ST06-12048 TCNC	A64428	CH-12867 PURO	A721	CH-12660 HRMO	A793	CH-16873 PRFX	A830X9601CH	CH-12248 FORD
A590	CH-12386 TCNC	A64551	CH-12225 PURO	A724	CH-12273 TCNC	A795	CH-12980 PRFX	A830X9601CJ	CH12-12251 FORD
A590C	CH-12268 AC	A64559	CH-12276 PURO	A726	CH-12269 TCNC	A797	CH-12238 PRFX	A830X9601CK	CH-16873 FORD
A596	CH-12282 PRFX	A64560	SC10-11317 PURO	A726C	CH-12268 AC	A799	CH-12248 PRFX	A830X9601CL	CH-12235 FORD
A597	CH-12246 PRFX	A646C	CH-12209 AC	A727C	CH10-11308 AC	A800	CH-12826 PRFX	A830X9601LA	CH05-11106 FORD
A598	CH-12386 PRFX	A64C	CH-12232 AC	A728	SC-12270 TCNC	A800X-9601-H	CH-11348 FORD	A830X9601SA	CH-12231 FORD
A599	CH-12385 PRFX	A-65	CH-12660 WIX	A72897	CH-12268 PURO	A801	CH-12231 PRFX	A830X9601UA	CH08-11288 FORD
A-59999	CH08-12243 CASE	A650	CH-12210 LBF	A72921	SC21-17075 PURO	A802	CH-11211 PRFX	A846C	CH-12385 AC
A-60	PF-15684 ATLAS	A651	CH-13150 LBF	A72922	CH21-17070 PURO	A803	CH-12213 PRFX	A-85	CH14-12245 WIX
A600	CH-12242 PRFX	A653	CH-12208 LBF	A731	CH-12238 TCNC	A804	CH-12289 PRFX	A858C	PF-15683 AC
A600	CH10-12224 TCNC	A654	CH-13157 LBF	A73162	CH14-13356 PURO	A806	CH-12247 PRFX	A865	CH-12249 PRFX
A602	CH-12235 PRFX	A658	CH-12826 LBF	A73163	SC14-13357 PURO	A807	CH-12091 PRFX	A866	CH-12397 PRFX
A602C	CH-12847 AC	A659	CH-12207 LBF	A732	CH-12275 LBF	A808	CH-12264 PRFX	A866PL	CH-12397 PRFX
A-60743	CH12-12251 DAVEY	A-66	CH12-11389 WIX	A732	CH10-11308 TCNC	A809	CH-12232 PRFX	A869	SC-12274 PRFX
A609	CH-12273 VIC	A660	CH-12207 LBF	A734	CH10-11308 LBF	A813	CH-12278 PRFX	A870	SC14-13357 LBF
A614C	CH05-11467 AC	A662	CH-12260 LBF	A734	SC10-11317 TCNC	A814	ST-13530 PRFX	A871	CH-12283 PRFX
A61568	CH-12242 PURO	A662C	CH-12282 AC	A73498	CH-12235 PURO	A815	ST-13531 PRFX	A873	ST06-11315 PRFX
A616	CH-12206 HRMO	A663	CH-11348 TCNC	A735	SC10-11317 LBF	A819	CH-13141 LBF	A875	SC10-11317 PRFX
A61605	CH-12386 PURO	A665	CH-12214 LBF	A73502	SC18-17232 PURO	A820	CH08-11288 LBF	A876	CH-12276 PRFX
A618	CH-12839 HRMO	A-665	CH-14152 TCNC	A73536	CH18-17230 PURO	A821	ST08-11316 LBF	A877	ST-13527 PRFX
A619C	ST-12226 AC	A666	CH-13156 LBF	A736	CH-12246 TCNC	A821	CH-12225 PRFX	A878	CH09-12244 PRFX
A62044	CH08-11288 PURO	A670C	ST06-11315 AC	A737	CH-12289 TCNC	A830X9601AA	CH-12980 FORD	A879	CH-12285 PRFX
A62055	CH-13150 PURO	A671C	CH06-11295 AC	A742	CH-15304 TCNC	A830X9601AB	CH-12386 FORD	A880	ST-16487 PRFX

Number Finder



MFRS. NO.	OUR NO. MFR	MFRS. NO.	OUR NO. MFR	MFRS. NO.	OUR NO. MFR	MFRS. NO.	OUR NO. MFR	MFRS. NO.	OUR NO. MFR
A880C	PF-15677 AC	ABU8516	PF-15680 LEYL	ACU2915	CH-12781 LEYL	ADG731	CH-12246 GUD	AEM2542	CH12-11343 COPR
A883	CH06-11056 PRFX	ABU8517	CH-12213 LEYL	ACU3426	CH14-12245 LEYL	ADG752	CH-12857 GUD	AEM2542	CH-13477 COPR
A884	ST-12226 PRFX	ABU8518	CH-12660 LEYL	ACU3994	CH-13050 LEYL	ADG756	CH-12247 GUD	AEM2556	CH-12825 COPR
A886	CH-12387 PRFX	ABU8521	CH-12250 LEYL	ACU7896	CH08-11288 LEYL	ADG761	CH-12231 GUD	AEM2560	CH-13185 COPR
A888C	ST-14343 AC	ABU8521	CH-16874 LEYL	ACU8223	CH-12278 LEYL	ADG766	ST-16487 GUD	AEM2630	CH-12775 COPR
A889C	CH09-12244 AC	ABU8522	CH-12242 LEYL	ACU9896	CH-12276 LEYL	ADG768	CH-12264 GUD	AEM2632	CH-14107 COPR
A890	ST-13529 PRFX	ABU8524	CH-12235 LEYL	ADG381	CH-12209 GUD	ADG779	CH-12491 GUD	AEM2752	CH-16689 COPR
A891	CH-12272 LBF	ABU8525	CH-12385 LEYL	ADG458	CH-12091 GUD	ADG780	CH-12485 GUD	AEP3514	PF-15677 COPR
A891	CH-12271 PRFX	ABU8529	CH-12264 LEYL	ADG478	SC-12274 GUD	ADG792	ST-13531 GUD	AEP3515	PF-14090 COPR
A892	CH-12272 PRFX	ABU8530	CH-11211 LEYL	ADG479	CH-12273 GUD	ADG794	CH-12278 GUD	AEP3515	PFM-14095 COPR
A899	CH-12271 LBF	ABU8531	CH-12289 LEYL	ADG491	SC-12270 GUD	ADG808	CH-12386 GUD	AEP3516	PF-15686 COPR
A901C	CH21-17070 AC	ABU8785	CH-12246 LEYL	ADG492	CH-12269 GUD	ADG829	CH-12236 GUD	AEP3518	PF-15690 COPR
A902C	SC21-17075 AC	ABU9670	CH14-12245 LEYL	ADG494	CH12-11389 GUD	AE-063150	CH14-12245 MTSB	AEP3519	PF-15693 COPR
A906	CH-13889 PRFX	ABU9896	CH-12276 LEYL	ADG508	CH-12225 GUD	AE-063155	SC14-12254 MTSB	AES2015	SC18-17232 COPR
A910C	ST09-12265 AC	AC203	PF-15683 AOTP	ADG516	CH-12385 GUD	AE-31723	CH06-11056 JDEER	AES2023	SC21-17075 COPR
A914	CH04-11675 PRFX	AC210	CH-12839 JCB	ADG518	CH08-12221 GUD	AE31724	ST-12226 KUK	AES2027	CH-12272 COPR
A916	CH-13150 PRFX	AC214	PF-15684 AOTP	ADG519	CH08-11288 GUD	AE-31724	ST-12226 JDEER	AES2045	ST-14343 COPR
A920	CH-13141 PRFX	AC224	CH-12208 FLUXF	ADG524	CH14-12245 GUD	AEK2030	CH-12275 COPR	AES2047	ST-13410 COPR
A922	CH-12208 PRFX	AC226	CH-12214 FLUXF	ADG525	SC14-12254 GUD	AEK2046	CH05-11467 COPR	AES2051	SC-15604 COPR
A923	CH-12214 PRFX	AC233	CH-12210 FLUXF	ADG533	SC12-11391 GUD	AEK2128	CH06-14733 COPR	AES2069	CH-12605 COPR
A948	CH-12234 PRFX	AC235	PF-15684 AOTP	ADG534	CH08-11288 GUD	AEK2494	CH06-11056 COPR	AES2077	SC14-13357 COPR
A949	CH10-11308 PRFX	AC236	CH-13156 FLUXF	ADG535	ST08-11316 GUD	AEK2522	CH-12290 COPR	AES2091	CH-12279 COPR
A953C	CH18-17230 AC	AC237	CH-13157 FLUXF	ADG537	CH10-11308 GUD	AEK2568	CH-13270 COPR	AES2265	ST06-11315 COPR
A956	CH-12809 PRFX	AC266SY	CH-13141 FLUXF	ADG538	SC10-11317 GUD	AEK2574	CH-13473 COPR	AES2279	ST06-11109 COPR
A969	CH-15304 PRFX	AC-3284	CH-12386 PBR	ADG543	CH05-11106 GUD	AEK2576	CH-12770 COPR	AES2281	ST-16488 COPR
A970	CH-12507 PRFX	AC535	CH-12273 FLUXF	ADG546	CH-12208 GUD	AEK2578	CH08-14835 COPR	AES2283	ST-13528 COPR
A971	CH-15294 PRFX	AC-7472	CH10-12224 NPON	ADG563	CH12-12251 GUD	AEK2584	CH-12770 COPR	AES2285	ST-16487 COPR
A976C	CH-12234 AC	AC-7472S	CH10-12224 NPON	ADG577	CH-12231 GUD	AEK2608	CH10-12390 COPR	AES2287	CH-13141 COPR
AA-163	PF-14090 APCO	AC-7473	CH10-11308 NPON	ADG586	CH06-11295 GUD	AEK2608	CH10-14455 COPR	AES2391	CH-12225 COPR
AA-163	PFM-14095 APCO	AC74735	CH10-11308 MP	ADG587	ST06-11315 GUD	AEM2000	CH-12289 COPR	AES2495	ST-12226 COPR
AA348T	CH06-12258 COPR	AC-74735	CH10-11308 NPON	ADG603A	CH-12386 GUD	AEM2014	CH18-17230 COPR	AES2523	ST-14113 COPR
AAU3669	CH-12839 LEYL	AC-7473S	CH10-11308 NPON	ADG617	CH-12275 GUD	AEM2022	CH21-17070 COPR	AES2563	ST-14787 COPR
ABP3001558	SC-12274 AVBA	AC7486	CH14-12245 MP	ADG619	CH09-12244 GUD	AEM2026	CH-12271 COPR	AES2595	ST-16938 COPR
ABP3001559	SC18-17232 AVBA	AC-7486	CH14-12245 NPON	ADG620	ST09-12265 GUD	AEM2050	CH-15565 COPR	AES2609	SC10-12395 COPR
ABP3001560	CH18-17230 AVBA	AC7489S	CH06-11038 MP	ADG625	CH06-11056 GUD	AEM2068	CH-12604 COPR	AF-10-0890	CH-12262 PURO
ABP3001562	CH-12209 AVBA	ACA-224	CH-12208 QIFA	ADG626	ST-12226 GUD	AEM2076	CH14-13356 COPR	AF-10-089084	CH-12262 PURO
ABP3001562	CH-12209 SAND	ACA-226	CH-12214 QIFA	ADG631	ST-13530 GUD	AEM2090	CH-12500 COPR	AF-103	CH-12260 HAST
ABP3001567	CH-12867 AVBA	ACA-226-SY	CH-13141 QIFA	ADG644	CH-13157 GUD	AEM2102	CH-12264 COPR	AF-1031	PF-15684 CHAMP
ABP3001567	CH-12867 SAND	ACA-233	CH-12210 QIFA	ADG649	CH-12214 GUD	AEM2128	CH06-14733 COPR	AF-1031	PF-15684 LEE
ABP3001571	ST08-11110 AVBA	ACA-234	CH-13150 QIFA	ADG650	CH-13156 GUD	AEM2134	CH-12236 COPR	AF-1031	PF-15684 LBRF
ABP3001571	ST08-11110 SAND	ACA-236	CH-13156 QIFA	ADG651	CH-12210 GUD	AEM2136	CH-12216 COPR	AF-104	CH-12208 HAST
ABP3001572	CH-12273 AVBA	ACA-237	CH-13157 QIFA	ADG652	CH-13150 GUD	AEM2138	CH-12216 COPR	AF-105	CH-13157 HAST
ABP30018962	CH-12209 AVBA	ACA-252	CH-12262 QIFA	ADG654	CH-13157 GUD	AEM2154	CH-12282 COPR	AF-106	CH-12207 HAST
ABP3003085	CH05-11106 AVBA	ACA-507-SY	SC14-12254 QIFA	ADG674	CH-12242 GUD	AEM2176	CH-12302 COPR	AF1072C	PF-14090 AC
ABU4557	CH16-12253 LEYL	ACA-508	CH-12275 QIFA	ADG694	CH14-12245 GUD	AEM2188	CH-11348 COPR	AF1072C	PFM-14095 AC
ABU6138	CH14-12245 LEYL	ACA-510	CH08-12221 QIFA	ADG695	CH08-12221 GUD	AEM2486	CH14-12245 COPR	AF-108	CH-12214 HAST
ABU6151	SC12-11391 LEYL	ACA-523-SY	SC12-11391 QIFA	ADG699	ST-14343 GUD	AEM2496	CH-12286 COPR	AF109	CH-12403 GOLD
ABU8506	CH-12262 LEYL	ACA-546	CH10-11308 QIFA	ADG708	ST08-12229 GUD	AEM2510	CH-14104 COPR	AF-116	CH-13156 HAST
ABU8508	CH12-12251 LEYL	ACU2889	CH-12752 LEYL	ADG709	CH08-12228 GUD	AEM2512	CH-12209 COPR	AF-117	CH-13150 HAST

Number Finder



MFRS. NO.	OUR NO. MFR	MFRS. NO.	OUR NO. MFR	MFRS. NO.	OUR NO. MFR	MFRS. NO.	OUR NO. MFR	MFRS. NO.	OUR NO. MFR
AF-118	CH-12210 HAST	AF1960	CH-13510 FLEET	AF-217	CH12-11389 HAST	AF25230	ST-17470 FLEET	AF25538	CH04-14412 FLEET
AF-1275	CH05-11106 CHAMP	AF1961	CH-13520 FLEET	AF2170	CH-12283 HAST	AF25249M	CH-15300 FLEET	AF25539	CH05-14409 FLEET
AF-133K	CH05-11106 HAST	AF1962	CH-12604 FLEET	AF-218	CH14-12245 HAST	AF25250	CH-13889 FLEET	AF25551	CH05-15887 FLEET
AF-14	PF-15677 PURO	AF1963	CH-12605 FLEET	AF2183	CH-12282 HAST	AF25251	CH-13939 FLEET	AF25555	CH-17490 FLEET
AF-1418	CH12-11389 CHAMP	AF1966	ST-14343 FLEET	AF2184	CH-12247 HAST	AF25260	CH-14387 FLEET	AF25558	ST08-17366 FLEET
AF-1418	CH12-11389 LBRF	AF1980	ST08-11110 FLEET	AF2187	ST08-12229 HAST	AF25264	CH-14900 FLEET	AF25565	CH-16490 FLEET
AF-15	PF-14090 CHAMP	AF-19847	CH05-11106 JDEER	AF-219	SC14-12254 HAST	AF25290	CH05-14409 FLEET	AF25566	ST-16494 FLEET
AF-15	PFM-14095 CHAMP	AF-20	PF-14090 HAST	AF-2199	SC-12270 PURO	AF25291	CH07-14865 FLEET	AF25574	PF-15701 FLEET
AF-153K	CH08-12221 HAST	AF-20	PFM-14095 HAST	AF-2200	SC14-12254 PURO	AF25292	CH08-17365 FLEET	AF25575	CH05-15887 FLEET
AF-154K	CH-12275 HAST	AF-2007	CH-12403 HAST	AF-2202	CH-12269 PURO	AF25302	CH-14722 FLEET	AF25618	ST09-16731 FLEET
AF1601M	CH-12232 FLEET	AF-2011	CH-12286 HAST	AF-2204K	CH10-11308 PURO	AF25303	ST-14715 FLEET	AF25619	CH-16521 FLEET
AF1604	SC18-17232 FLEET	AF-2011	CH04-11675 PURO	AF-2206	SC-12274 PURO	AF25305	PF-15441 FLEET	AF25622	SC-16522 FLEET
AF1605M	CH18-17230 FLEET	AF-2011K	CH04-11675 PURO	AF-2220	CH12-11389 PURO	AF25306	PF-15699 FLEET	AF25627	CH-16922 FLEET
AF1606K	CH06-14733 FLEET	AF-2016	CH-12231 HAST	AF-2220H	CH12-11389 PURO	AF25313	CH-14902 FLEET	AF25672	PF-15669 FLEET
AF1606KM	CH06-14733 FLEET	AF-2019	CH05-11106 PURO	AF-2221	CH14-12245 PURO	AF25314	CH-14896 FLEET	AF25702	ST-15255 FLEET
AF1614	CH-12752 FLEET	AF-2019K	CH05-11106 PURO	AF-2222	CH-12273 PURO	AF25315K	CH-14154 FLEET	AF25703K	CH-15267 FLEET
AF1615	CH-12212 FLEET	AF-2029	CH-12232 HAST	AF2234	CH-12485 HAST	AF25319	PF-15700 FLEET	AF25715RH	ST-15411 FLEET
AF-1625	SC10-11317 CHAMP	AF-2029	CH-12209 PURO	AF2235	CH-12491 HAST	AF25321	ST-14183 FLEET	AF25716RH	ST-15400 FLEET
AF1658K	CH04-11675 FLEET	AF-20325	CH-12232 IRLMP	AF-2238K	CH05-12222 PURO	AF25326	SC-15681 FLEET	AF25721	CH-16491 FLEET
AF-167K	CH04-11675 HAST	AF-2039K	CH08-12221 PURO	AF2240	CH-12249 HAST	AF25331	CH-14237 FLEET	AF25722	ST-16495 FLEET
AF-17064	CH-12262 PURO	AF-2040	CH08-12243 PURO	AF2241	CH-12278 HAST	AF25333	CH-16523 FLEET	AF25723	CH-16492 FLEET
AF1733K	CH08-11288 FLEET	AF-2044K	CH08-11288 PURO	AF-2255	CH-14104 PURO	AF25335	CH-15673 FLEET	AF25724	ST-16496 FLEET
AF1735K	CH09-12244 FLEET	AF2049	CH-12206 HAST	AF-2256	SC10-11317 PURO	AF25337M	CH-15475 FLEET	AF25726	ST-16877 FLEET
AF1752M	CH-12289 FLEET	AF-2051	CH-12275 PURO	AF2262	CH-14722 HAST	AF25343	CH-14334 FLEET	AF-25727	CH-16489 FLEET
AF1773	PF-15683 FLEET	AF-2051K	CH-12275 PURO	AF-2266	SC12-11391 PURO	AF25344	CH-14340 FLEET	AF25728	ST-16493 FLEET
AF1782	CH-12781 FLEET	AF-2052	CH-13157 PURO	AF-2266H	SC12-11391 PURO	AF25348K	CH08-14835 FLEET	AF25729	CH-16881 FLEET
AF1798	CH-12234 FLEET	AF-2053	CH-13156 PURO	AF-2269	CH14-12245 PURO	AF25351	CH-12870 FLEET	AF25730	ST-16875 FLEET
AF1801	CH-12980 FLEET	AF-2055	CH-13150 PURO	AF-229	CH-12209 CHAMP	AF25352	CH08-14410 FLEET	AF25741	ST-12689 FLEET
AF1802	CH-12278 FLEET	AF2058	CH-12397 HAST	AF235	CH-12809 HGST	AF25353	CH-13644 FLEET	AF25753	ST-15557 FLEET
AF1804	CH-12238 FLEET	AF2060	CH-12213 HAST	AF-235K	CH08-11288 HAST	AF25424	ST-16879 FLEET	AF25756	CH-14888 FLEET
AF1823K	CH05-11467 FLEET	AF2068	CH-12242 HAST	AF-237	CH12-12251 CHAMP	AF25434	ST05-14402 FLEET	AF25767	CH-16969 FLEET
AF1824	ST-13410 FLEET	AF-2073K	CH12-12251 PURO	AF-245K	CH10-11308 HAST	AF25436	CH06-16050 FLEET	AF25768	ST-16970 FLEET
AF1830KM	CH06-11056 FLEET	AF2079	CH-12289 HAST	AF-246	SC10-11317 HAST	AF25437	CH-16689 FLEET	AF25769	CH-16971 FLEET
AF1835	CH-12867 FLEET	AF2082	CH-11020 HAST	AF-24650	CH-16873 IRLMP	AF25454	CH-16294 FLEET	AF25770	ST-16972 FLEET
AF1839	ST-12226 FLEET	AF2092	CH-12235 HAST	AF-24650/1	CH-12235 IRLMP	AF25457	ST-17103 FLEET	AF25773GK	PF-15015 FLEET
AF1840	ST-13531 FLEET	AF2095	CH-12285 HAST	AF25000	CH-13090 FLEET	AF25468	SC-16301 FLEET	AF25794	ST08-14708 FLEET
AF1841	ST-13527 FLEET	AF-2102	CH-12249 PURO	AF25002M	CH-13075 FLEET	AF25484	ST07-14270 FLEET	AF25795	CH08-14703 FLEET
AF1842	ST-13530 FLEET	AF-2110	CH-12260 PURO	AF25006K	CH-13824 FLEET	AF25485	ST08-14413 FLEET	AF25797	PF-15672 FLEET
AF1843	ST-13529 FLEET	AF-2110K	CH-12260 PURO	AF25029	CH-14380 FLEET	AF25490	ST-16880 FLEET	AF25799	PF-14910 FLEET
AF1845K	CH06-12258 FLEET	AF-2114	CH-12212 PURO	AF25057	CH12-11343 FLEET	AF25491	ST10-15380 FLEET	AF25825	PF-15470 FLEET
AF-1853M	CH-12268 CHAMP	AF-2125	CH-12260 PURO	AF25057	CH-13477 FLEET	AF25492	CH-16928 FLEET	AF25841	PF-15671 FLEET
AF1859	SC06-11252 FLEET	AF-2140	CH14-12245 PURO	AF25060KM	CH-13473 FLEET	AF25497	ST06-16054 FLEET	AF25849	PF-15891 FLEET
AF1869	PF-14090 FLEET	AF2153	CH-13157 HAST	AF25061	CH-13190 FLEET	AF25499	ST-17092 FLEET	AF25855	PF-15857 FLEET
AF1869	PFM-14095 FLEET	AF2154	CH-13156 HAST	AF25064	CH-12385 FLEET	AF25500K	CH-14211 FLEET	AF25957	CH09-16729 FLEET
AF1904M	SC14-12254 FLEET	AF2158	CH-12234 HAST	AF25065	CH-12242 FLEET	AF25502K	CH-12290 FLEET	AF25964	CH10-15371 FLEET
AF1905M	CH14-12245 FLEET	AF-216	SC12-11391 HAST	AF25066	CH-12387 FLEET	AF25503	ST-14113 FLEET	AF25978	ST08-14829 FLEET
AF1927	CH-13050 FLEET	AF2164	CH-12206 HAST	AF25084	ST-16938 FLEET	AF25523	SC-16290 FLEET	AF26119	PF-16185 FLEET
AF1929	CH-12276 FLEET	AF2166	CH-12248 HAST	AF25200K	CH-12739 FLEET	AF25526	CH07-14074 FLEET	AF26190VJ	PF-16591 FLEET
AF1945	CH-12857 FLEET	AF2168	CH06-11941 HAST	AF25221	PF-15703 FLEET	AF25529	ST-14787 FLEET	AF26230	CH-16284 FLEET

Number Finder



MFRS. NO.	OUR NO. MFR	MFRS. NO.	OUR NO. MFR	MFRS. NO.	OUR NO. MFR	MFRS. NO.	OUR NO. MFR	MFRS. NO.	OUR NO. MFR
AF26348	CH-16888 FLEET	AF-3175	CH-12271 PURO	AF4020	CH-12206 FLEET	AF-4536	CH-12091 PURO	AF4892K	CH-13270 FLEET
AF26387	CH-16878 FLEET	AF-3176	CH-12272 PURO	AF4024	CH-12177 FLEET	AF-4548	CH-12403 PURO	AF4893M	CH-12790 FLEET
AF26403	CH-17541 FLEET	AF-319	CH-12847 HAST	AF4027	CH-12213 FLEET	AF4551	CH-12225 FLEET	AF4894KM	CH10-12390 FLEET
AF26419	CH-17542 FLEET	AF-3192	PF-15683 PURO	AF4039	CH-12660 FLEET	AF-4551	CH-12225 PURO	AF4894KM	CH10-14455 FLEET
AF26439	CH-17203 FLEET	AF-323	CH-12268 HAST	AF4047	CH-12204 FLEET	AF-4559	CH-12276 PURO	AF-490	CH-12271 HAST
AF-265HD	CH-12262 CHAMP	AF-324K	CH05-12222 HAST	AF4049	PF-15680 FLEET	AF-4560	SC10-11317 PURO	AF4901	CH-13404 FLEET
AF-2745A	CH04-11675 CHAMP	AF-3253	CH-12282 PURO	AF4057	CH-12248 FLEET	AF4565	CH-12500 FLEET	AF4905M	CH-12798 FLEET
AF2771	CH-12273 MP	AF-327	CH-12269 HAST	AF4058	CH-12386 FLEET	AF4566	CH-12279 FLEET	AF4909K	CH-13811 FLEET
AF-2771	CH-12273 NPON	AF-328	SC-12270 HAST	AF4059K	CH08-11288 FLEET	AF-4568	CH-12241 FLEET	AF490M	SC12-11391 FLEET
AF27843	CH-17594 FLEET	AF-3310	CH-12206 PURO	AF4060	CH-12235 FLEET	AF4569	CH-12498 FLEET	AF-491	CH-12272 HAST
AF27854	PF-17644 FLEET	AF-3314	SC10-12395 PURO	AF4064	CH-12653 FLEET	AF4570K	CH06-11941 FLEET	AF4915	PF-15690 FLEET
AF27866	PF-17844 FLEET	AF-3332	CH-12209 PURO	AF4066	CH-12397 FLEET	AF-458	ST06-11315 HAST	AF4916	PF-15693 FLEET
AF27869	CH-17762 FLEET	AF-334	CH-12214 CHAMP	AF-4067	CH-12230 FLEET	AF4589	SC10-12395 FLEET	AF4917	CH-11789 FLEET
AF27960	PF-18174 FLEET	AF-3346	CH-12177 PURO	AF4074	CH-12215 FLEET	AF4597	PF-15684 FLEET	AF492	CH-12209 FLEET
AF27963	PF-18559 FLEET	AF-335	CH-13156 CHAMP	AF4078	CH-12216 FLEET	AF4608	PF-15686 FLEET	AF4920	CH-13763 FLEET
AF-284	SC-12274 HAST	AF335M	CH-12214 FLEET	AF4084	CH-12250 FLEET	AF4609	CH-12403 FLEET	AF4927	CH-15294 FLEET
AF-2896	ST-12226 PURO	AF-336	PF-15677 HAST	AF4084	CH-16874 FLEET	AF-463	CH10-11308 HAST	AF4939	CH-12716 FLEET
AF-2897	CH-12268 PURO	AF336M	CH-12210 FLEET	AF4085	CH-11348 FLEET	AF4641M	CH-11211 FLEET	AF4941	CH08-12243 FLEET
AF-2908	ST06-11315 PURO	AF337	CH-12207 FLEET	AF4088	CH-12249 FLEET	AF4643	CH-12286 FLEET	AF-496	CH-13141 HAST
AF-2909	CH06-11295 PURO	AF338	CH-13156 FLEET	AF409KM	CH08-11003 FLEET	AF4644	CH-12302 FLEET	AF4968	CH-14107 FLEET
AF-290A	CH-12260 CHAMP	AF-3393	CH08-11288 PURO	AF4102	CH-12219 FLEET	AF-465	SC-12274 HAST	AF4972	CH-12825 FLEET
AF-2915	CH05-11106 PURO	AF340	CH-13150 FLEET	AF4103	ST08-11316 FLEET	AF4654	ST06-12048 FLEET	AF-498	CH06-14733 HAST
AF-2918	CH-13141 PURO	AF-3425	CH-12809 PURO	AF4106	CH-12839 FLEET	AF4655KM	CH06-11880 FLEET	AF4980KM	CH-12345 FLEET
AF-2921	SC21-17075 PURO	AF-3427	CH-11211 PURO	AF4128	PF-15677 FLEET	AF4657	CH-15565 FLEET	AF4981M	CH-12794 FLEET
AF-2922	CH21-17070 PURO	AF343	CH-13157 FLEET	AF4135	CH-12231 FLEET	AF4658	SC-15604 FLEET	AF4991	CH-12775 FLEET
AF-2928	CH-13141 PURO	AF-3438	PF-14090 PURO	AF4137	CH-12091 FLEET	AF4663	PF-15688 FLEET	AF-5054A	CH-12275 CHAMP
AF-2952	SC14-13357 PURO	AF-3438	PFM-14095 PURO	AF4149	CH-12264 FLEET	AF4691	CH-12809 FLEET	AF511	CH-12236 HAST
AF-2973	CH05-11467 PURO	AF344M	CH-12208 FLEET	AF4150	ST09-12265 FLEET	AF-47	CH-12208 CHAMP	AF-514	CH09-12244 HAST
AF-2974	CH06-14733 PURO	AF-3459	ST08-11316 PURO	AF4164K	CH08-12228 FLEET	AF4714	CH-12093 FLEET	AF-515	ST09-12265 HAST
AF-300	PF-15684 CHAMP	AF-3465	PF-15684 PURO	AF4165	ST08-12229 FLEET	AF471M	SC-12252 FLEET	AF-5368	CH08-11288 CHAMP
AF-300	CH-14104 HAST	AF-3492	CH-12283 PURO	AF-417P	CH-12282 HAST	AF4720	CH-12283 FLEET	AF-576	CH21-17070 HAST
AF-300	PF-15684 LEE	AF-3498	CH-12235 PURO	AF418	CH12-11389 FLEET	AF472M	CH16-12253 FLEET	AF-577	SC21-17075 HAST
AF-300	PF-15684 LBRF	AF-3502	SC18-17232 PURO	AF418M	CH12-11389 FLEET	AF-4744	CH-12181 FLEET	AF-588	CH05-11467 HAST
AF-3028	CH09-12244 PURO	AF350KM	CH10-12224 FLEET	AF421M	CH-12273 FLEET	AF4745	ST-16876 FLEET	AF-597	CH-12867 HAST
AF-3029	ST09-12265 PURO	AF-3511	ST08-11110 PURO	AF424	CH14-12245 FLEET	AF-4747	CH08-12221 CHAMP	AF-602	PF-15683 CHAMP
AF-3031	ST06-11315 PURO	AF-3516	ST-13410 PURO	AF424M	CH14-12245 FLEET	AF4748K	CH08-11935 FLEET	AF-602	PF-15683 LEE
AF-3098	ST-16488 PURO	AF-3519	CH-12385 PURO	AF427M	CH-12269 FLEET	AF4758KM	CH-12770 FLEET	AF-602	PF-15683 LBRF
AF-3100	ST-13530 PURO	AF-3536	CH18-17230 PURO	AF434KM	CH10-11308 FLEET	AF-477	CH08-11288 HAST	AF-6154	CH-12278 IRLMP
AF-3101	ST-13531 PURO	AF-3537	CH-12285 PURO	AF435KM	CH05-11106 FLEET	AF4775	CH-12277 FLEET	AF-6182	ST-13527 IRLMP
AF-3102	ST-13527 PURO	AF353K	CH12-12251 FLEET	AF437KM	CH06-11038 FLEET	AF-478	ST08-11316 HAST	AF-631	ST-14343 HAST
AF-3103	ST-13529 PURO	AF354	CH-12262 FLEET	AF-4428	CH-12867 PURO	AF-480	CH06-11295 HAST	AF-635	CH-12385 HAST
AF-3104	ST-13528 PURO	AF-3549	CH-12264 PURO	AF4500	CH-12485 FLEET	AF-481	CH08-11288 HAST	AF-637	CH-12225 HAST
AF-3112	CH-12213 PURO	AF361	CH-12260 FLEET	AF4501	CH-12491 FLEET	AF4841	CH-15304 FLEET	AF638	CH-12091 HAST
AF-3116	CH-12225 PURO	AF361M	CH-12260 FLEET	AF4503	CH-12278 FLEET	AF4850	ST05-14980 FLEET	AF-639	CH-12386 HAST
AF-3152	CH06-11056 PURO	AF-362	CH-12209 HAST	AF4510	ST06-11109 FLEET	AF4856M	CH08-11942 FLEET	AF-643	CH-12276 HAST
AF-3156	ST-14343 PURO	AF-363K	CH06-11056 HAST	AF4521	ST-16488 FLEET	AF4867	CH-12507 FLEET	AF-644	SC10-11317 HAST
AF-3157	SC10-11317 PURO	AF-365	ST-12226 HAST	AF4522	ST-16487 FLEET	AF4872	CH-12847 FLEET	AF-648	CH-12177 HAST
AF-3162	CH14-13356 PURO	AF-370	CH14-13356 HAST	AF4523	ST-13528 FLEET	AF4890	CH-13185 FLEET	AF-658	CH18-17230 HAST
AF-3163	SC14-13357 PURO	AF-371	SC14-13357 HAST	AF4525	CH-12953 FLEET	AF4891M	CH-13074 FLEET	AF-659	SC18-17232 HAST

Number Finder



MFRS. NO.	OUR NO. MFR	MFRS. NO.	OUR NO. MFR	MFRS. NO.	OUR NO. MFR	MFRS. NO.	OUR NO. MFR	MFRS. NO.	OUR NO. MFR
AF-661	ST-13410 HAST	AF978	CH-12246 FLEET	AG156	SC21-17075 KNCT	AH/1007	CH-12225 GS	AH19002	DL-16862 FLEET
AF-673	PF-14090 HAST	AF-97K	CH12-12251 HAST	AG179	CH-12209 KNCT	AH/1008	CH-12091 GS	AH19003	DL-16859 FLEET
AF-673	PFM-14095 HAST	AF981	CH-12236 FLEET	AG184	ST08-11316 KNCT	AH/1009	CH-12235 GS	AH19004	DL-16864 FLEET
AF-6769	CH14-12245 CHAMP	AF988	ST06-11315 FLEET	AG187	CH-12249 KNCT	AH/1010	CH-12385 GS	AH19037	DL-16141 FLEET
AF-6834	SC12-11391 CHAMP	AF990	CH-12285 FLEET	AG200	CH-12213 KNCT	AH/1011	CH-12213 GS	AH19220	DL-17336 FLEET
AF-7092	CH-12282 CHAMP	AF991	CH-12225 FLEET	AG202	CH-12225 KNCT	AH/1012	CH-12660 GS	AH-19846	CH05-11106 JDEER
AF-744	SC10-12395 HAST	AF996M	CH-11020 FLEET	AG206	CH-12212 KNCT	AH/1014	CH-16873 GS	AH-19847	CH05-11106 JDEER
AF-755	CH-12215 HAST	AFI-6003	CH-12212 IRLMP	AG207	CH08-11288 KNCT	AH/1015	CH14-12245 GS	AH-20487-H	CH08-12243 JDEER
AF-756	CH-12216 HAST	AFI-6004	CH-12249 IRLMP	AG235	CH-12809 KNCT	AH/1017	CH-12242 GS	AH-21421	CH08-12221 JDEER
AF-762	CH14-12245 HAST	AFI-6041	CH-12216 IRLMP	AG243	CH-11211 KNCT	AH/1018	CH08-11288 GS	AH30	CH-11348 GS
AF7849	CH-12272 LBRF	AFI-6042	CH-12215 IRLMP	AG262	CH-12285 KNCT	AH/1019	CH-12386 GS	AH8513	DL-15751 FLEET
AF-788	CH-12262 HAST	AFI-6121	ST-16488 IRLMP	AG265	PF-15684 COPR	AH/1022	CH-12283 GS	AI-3003	PF-15677 PBR
AF-8047	CH-12208 PURO	AFI-6123	ST-16487 IRLMP	AG273	CH-12289 KNCT	AH/1023	CH-11211 GS	AI-3012	CH-12215 PBR
AF804M	SC10-11317 FLEET	AFI-6159	ST-13531 IRLMP	AG274	CH-12264 KNCT	AH/1024	CH-12215 GS	AI-3129	CH-12249 PBR
AF818K	CH08-12221 FLEET	AFI-6180	ST-13530 IRLMP	AG300	CH-12870 KNCT	AH/1025	CH-12216 GS	AI-3203	CH-12214 PBR
AF819KM	CH05-12222 FLEET	AFI-6215	ST08-11110 IRLMP	AG305	CH-12212 GUD	AH/1026	SC12-11391 GS	AI-3205	CH-12207 PBR
AF820M	SC14-12254 FLEET	AFI-6220	ST-13529 IRLMP	AG373	CH-12249 COPR	AH/1027	CH-12285 GS	AI-3206	CH-13156 PBR
AF-8211	CH14-13356 CHAMP	AFI-6225	CH-11211 IRLMP	AG373	CH-12249 GUD	AH/1029	CH-12234 GS	AI-3207	CH-13157 PBR
AF-8216	SC14-13357 CHAMP	AFI-6225	CH-12283 IRLMP	AG381	CH-12209 COPR	AH/1030	CH-12238 GS	AI-3208	CH-12208 PBR
AF821M	SC-12274 FLEET	AFI-6226	CH-12264 IRLMP	AG383	CH-12213 COPR	AH/1033	CH-12246 GS	AI-3214	CH-12260 PBR
AF822M	SC-12270 FLEET	AFI-6235	CH-12980 IRLMP	AG383	CH-12213 GUD	AH/1035	CH-12247 GS	AI-3215	CH-13150 PBR
AF830	CH-14104 FLEET	AFI-6251-K	CH08-11288 IRLMP	AG385	CH-12660 COPR	AH/1036	CH-12250 GS	AI-3220	CH-12216 PBR
AF-836	PF-15684 HAST	AFI-6252	ST08-11316 IRLMP	AG385	CH-12660 GUD	AH/1036	CH-16874 GS	AI-3221	CH12-11389 PBR
AF-842	PF-15683 HAST	AFK-575	PF-15683 FDI	AG417	CH-12826 COPR	AH/1040	CH-12214 GS	AI-3225	CH-12262 PBR
AF851M	CH-12266 FLEET	AFL-1031	PF-15684 LEE	AG417	CH-12826 GUD	AH/1041	CH-12207 GS	AI-3233	CH-13141 PBR
AF853	CH-12268 FLEET	AFL-160	PF-15684 LEE	AG419	CH-12206 COPR	AH/1043	CH-13157 GS	AI-3236	CH-12264 PBR
AF859	ST06-11109 GOLD	AFL-3192	PF-15683 PRFL	AG445	CH-12660 COPR	AH/1044	CH-13156 GS	AI-3237	CH-12980 PBR
AF86	CH-12397 KNCT	AFL-575	PF-15683 LEE	AG445	CH-12660 GUD	AH/1045	CH-12208 GS	AI-3238	CH-12249 PBR
AF863M	CH-12282 FLEET	AFP-15	PF-14090 PURO	AG464	PF-15680 COPR	AH/1047	CH-12248 GS	AI-3239	CH14-12245 PBR
AF-8668	CH10-11308 CHAMP	AFP-15	PFM-14095 PURO	AG524	CH14-12245 GUD	AH/1053	ST08-11316 GS	AI-3240	SC14-12254 PBR
AF-87	CH-12262 HAST	AFR8435KM	CH05-11106 FLRIT	AG579	CH-12250 COPR	AH/1054	CH06-11295 GS	AI-3242	CH-12209 PBR
AF880	SC21-17075 FLEET	AG101	CH-12248 KNCT	AG579	CH-16874 COPR	AH/1056	CH-12278 GS	AI-3246	CH08-12243 PBR
AF889	SC14-13357 FLEET	AG102	CH-16873 KNCT	AG579	CH-12250 GUD	AH/1068	CH-12209 GS	AI-3247-08	CH12-12251 PBR
AF899M	CH21-17070 FLEET	AG103	CH-12232 KNCT	AG579	CH-16874 GUD	AH/1070	CH-12236 GS	AI-3254	CH-12204 PBR
AF901	CH14-13356 FLEET	AG108	CH-12206 COPR	AG64	CH-12234 KNCT	AH/1071	CH-12278 GS	AI-3270-08	CH-12275 PBR
AF-9045	CH-12210 PURO	AG108	CH-12206 GUD	AG74	CH-12385 KNCT	AH/1072	CH-12271 GS	AI-3273	CH08-11288 PBR
AF-9085	SC-12274 CHAMP	AG108	PF-15684 KNCT	AG86	CH-12397 KNCT	AH/1073	CH-12272 GS	AI-3274-08	CH06-11295 PBR
AF921M	CH-12271 FLEET	AG132	CH-12246 KNCT	AG87	CH-12231 KNCT	AH/1081	CH05-11106 GS	AI-3276-08	CH10-11308 PBR
AF922	CH-12272 FLEET	AG133	CH-12236 KNCT	AG88	CH-12386 KNCT	AH/1086	CH-12262 GS	AI-3277	SC10-11317 PBR
AF-9334	CH-12214 PURO	AG136	CH-12091 KNCT	AG89	CH-12235 KNCT	AH/1091	ST06-11315 GS	AI-3279	CH05-11106 PBR
AF-9378	CH-12207 PURO	AG137	CH05-11106 KNCT	AG90	CH-12278 KNCT	AH/1093	CH-12276 GS	AI-3279-08	CH05-11106 PBR
AF940K	CH06-11295 FLEET	AG139	CH-11348 GUD	AG94	CH-12238 KNCT	AH/1096	SC10-11317 GS	AI-3280	CH-12250 PBR
AF945K	CH-12275 FLEET	AG140	CH-12177 COPR	AG96	CH-12242 KNCT	AH/1109	CH-12397 GS	AI-3280	CH-16874 PBR
AF959	CH-13141 FLEET	AG140A	CH-12177 GUD	AG98	CH-12980 KNCT	AH1107	DL-17329 FLEET	AI-3282	CH-12826 PBR
AF-96	CH-12209 HAST	AG141	CH-12208 KNCT	AH/1001	SC14-12254 GS	AH1136	DL-16550 FLEET	AI-3284	CH-12386 PBR
AF969	CH-12826 FLEET	AG142	CH-12839 COPR	AH/1003	CH12-12251 GS	AH1141	DL-16560 FLEET	AI-3297-08	CH08-12221 PBR
AF970	CH-16873 FLEET	AG142	CH-12839 GUD	AH/1004	CH-12231 GS	AH1190	DL-17331 FLEET	AI-3298	ST08-11316 PBR
AF977	CH-12247 FLEET	AG145	CH12-12251 KNCT	AH/1005	CH-12264 GS	AH1196	DL-17335 FLEET	AI-3301	CH-12242 PBR
AF-9778	ST09-12265 CHAMP	AG155	CH21-17070 KNCT	AH/1006	CH12-11389 GS	AH1198	DL-17333 FLEET	AI-3302	CH-12385 PBR

Number Finder



MFRS. NO.	OUR NO. MFR	MFRS. NO.	OUR NO. MFR	MFRS. NO.	OUR NO. MFR	MFRS. NO.	OUR NO. MFR	MFRS. NO.	OUR NO. MFR
AI-3303	CH-12235 PBR	AP-11-7433	CH-12269 QIFA	AP-3350A	CH-12247 APLKH	AP-3527A	ST09-12265 APLKH	AP-846A	CH-12250 APLKH
AI-3307	CH-12231 PBR	AP-11-7435	CH-12273 QIFA	AP-3351	CH-12236 APLKH	AP-3528	CH-12276 APLKH	AP-846A	CH-16874 APLKH
AI-3309-08	CH06-11056 PBR	AP-11-7437	CH14-12245 QIFA	AP-3351A	CH-12236 APLKH	AP-3528A	CH-12276 APLKH	AP-848	CH-12262 APLKH
AI-3315	CH-12276 PBR	AP-11-7439	CH12-11389 QIFA	AP-3354A	CH08-11288 APLKH	AP-3529	SC10-11317 APLKH	AP-848A	CH-12262 APLKH
AI-3316	CH-12225 PBR	AP-11-7782	CH21-17070 QIFA	AP-3422	CH05-11106 APLKH	AP-3529A	SC10-11317 APLKH	AP-850K	CH12-12251 APLKH
AI-3320	CH-12247 PBR	AP-11-7797	CH-12268 QIFA	AP-3422K	CH05-11106 APLKH	AP-3530	CH06-11056 APLKH	AP-852A	CH-12260 APLKH
AI-3328	CH-16873 PBR	AP1185	CH-12264 TECF	AP3441	PF-15684 FCET	AP-3530A	CH06-11056 APLKH	AP-855	CH-12248 APLKH
AI-3332	ST-13531 PBR	AP-11-9363	CH08-11288 QIFA	AP-3446	CH-12231 APLKH	AP-3531	ST-12226 APLKH	AP-855A	CH-12248 APLKH
AI-3333	ST-13527 PBR	AP-12-8407	CH18-17230 QIFA	AP-3446A	CH-12231 APLKH	AP-3531A	ST-12226 APLKH	AP-856A	CH08-12243 APLKH
AI-3336-08	CH09-12244 PBR	AP-190	CH-12206 APLKH	AP-3451	CH-11211 APLKH	AP-3532	CH08-12228 APLKH	AP-860	CH08-11288 APLKH
AI-3338	CH-12266 PBR	AP-191	CH-12839 APLKH	AP-3451A	CH-11211 APLKH	AP-3532A	CH08-12228 APLKH	AP-860K	CH08-11288 APLKH
AI-3346	CH-12232 PBR	AP-192	CH-12177 APLKH	AP-3452	CH-12264 APLKH	AP-3533	ST08-12229 APLKH	AP903	CH05-11106 WPAC
AI-3350	ST09-12265 PBR	AP-192A	CH-12177 APLKH	AP-3452A	CH-12264 APLKH	AP-3533A	ST08-12229 APLKH	AP-923A	CH-12397 APLKH
AI-3352	CH-12397 PBR	AP2032	CH-12232 TECF	AP-3454	CH-12213 APLKH	AP-3550	CH06-12258 APLKH	AP-924K	CH08-12228 APLKH
AI-3357	ST-13530 PBR	AP2710	CH-12386 TECF	AP-3454A	CH-12213 APLKH	AP-3635	CH-12781 APLKH	AP-925	CH05-12222 APLKH
AI-3358	CH-12278 PBR	AP-3006K	CH-12268 APLKH	AP-3457	CH-12289 APLKH	AP-3658	ST-16487 APLKH	AP9834	CH-12385 TECF
AI-3358	CH-12278 PBR	AP-3007K	CH-12275 APLKH	AP-3486	CH-12752 APLKH	AP-3659	ST-13530 APLKH	AP9835	CH-12278 TECF
AI-3359	ST-13528 PBR	AP-3008	CH-13157 APLKH	AP-3486A	CH-12752 APLKH	AP-3660	ST-13531 APLKH	APF-3465-P	PF-15684 TOMI
AI-3361	ST-16487 PBR	AP-3008A	CH-13157 APLKH	AP-3497	CH04-11675 APLKH	AP-3661	ST-13527 APLKH	APH-3397A	CH-12091 APLKH
AI-3363	ST-16488 PBR	AP-3027	SC14-12254 APLKH	AP-3497A	CH04-11675 APLKH	AP-3662	ST-13529 APLKH	APP-190A	CH-12206 APLKH
AI-3369	CH-12604 PBR	AP-3027A	SC14-12254 APLKH	AP-3502	CH-12275 APLKH	AP367	PF-15684 WPAC	APP-191A	CH-12839 APLKH
AI-3370	CH-12605 PBR	AP-3028	CH-12266 APLKH	AP-3502A	CH-12275 APLKH	AP4440	CH-12242 TECF	APP-3132A	CH-11348 APLKH
AI-3373	CH-11789 PBR	AP-3029	CH05-12222 APLKH	AP-3504	SC12-11391 APLKH	AP4650	CH-16873 TECF	APP-3152A	CH-12249 APLKH
AI3381	CH-11211 PBR	AP-3032	CH05-12222 APLKH	AP-3504A	SC12-11391 APLKH	AP4650/1	CH-12235 TECF	APP-3342A	PF-15684 APLKH
AI-3394	CH-12387 PBR	AP-3032K	CH05-12222 APLKH	AP-3507	SC14-12254 APLKH	AP4934	CH-12214 TECF	APP-3345A	CH-12246 APLKH
AI-3410-08	CH06-11941 PBR	AP-3035A	CH-12268 APLKH	AP-3507A	SC14-12254 APLKH	AP4935	CH-13156 TECF	APP-744A	CH-12660 APLKH
AI-3446-08	CH-14211 PBR	AP-3036	CH-12208 APLKH	AP-3510	CH06-11295 APLKH	AP-500	CH-12177 APLKH	APP-764A	CH-12212 APLKH
AI-3679	CH-14387 PBR	AP-3036A	CH-12208 APLKH	AP-3510A	CH06-11295 APLKH	AP-500A	CH-12177 APLKH	AR-005	CH-12209 TECF
AI-5010	PF-15684 PBR	AP-3039A	CH-12262 APLKH	AP-3511	ST06-11315 APLKH	AP5569	CH-12283 TECF	AR-1185	CH-12264 TECF
AI-5031	PF-15686 PBR	AP-3152	CH-12249 APLKH	AP-3511A	ST06-11315 APLKH	AP6460	CH-12980 TECF	AR1570	CH21-17070 INDUC
AI-5109	PF-15690 PBR	AP-3164	CH-12215 APLKH	AP-3516	CH-12269 APLKH	AP-651	CH-12209 APLKH	AR1570SY	SC21-17075 INDUC
AI5169	PF-15693 PBR	AP-3164A	CH-12215 APLKH	AP-3516A	CH-12269 APLKH	AP-651A	CH-12209 APLKH	AR2	PF-15677 INDUC
AK-120	CH05-11106 WIX	AP-3165A	CH-12216 APLKH	AP-3517	SC-12270 APLKH	AP-700	CH12-11389 APLKH	AR-2032	CH-12232 TECF
AL-19918	CH-12275 JDEER	AP-3290	CH-12953 APLKH	AP-3517A	SC-12270 APLKH	AP-700A	CH12-11389 APLKH	AR-21424	CH08-12221 JDEER
AL-27158	CH-12275 JDEER	AP-3290A	CH-12953 APLKH	AP-3518	CH-12273 APLKH	AP-706A	CH-12660 APLKH	AR216	CH-12207 INDUC
AL-27159	ST-12226 JDEER	AP-3309	ST08-11316 APLKH	AP-3518A	CH-12273 APLKH	AP7108	CH-12231 TECF	AR224	CH-12208 INDUC
AL-3359	ST-13528 PBR	AP-3323	CH-12242 APLKH	AP-3519	SC-12274 APLKH	AP-712	CH-12213 APLKH	AR226	CH-12214 INDUC
AL-3361	ST-16487 PBR	AP-3323A	CH-12242 APLKH	AP-3519A	SC-12274 APLKH	AP-712A	CH-12213 APLKH	AR226SY	CH-13141 INDUC
AL-3363	ST-16488 PBR	AP-3331	CH-12386 APLKH	AP-3521	SC21-17075 APLKH	AP-713	CH-12653 APLKH	AR229	CH-12209 INDUC
AM044901	CH12-12251 PRPT	AP-3331A	CH-12386 APLKH	AP-3521A	SC21-17075 APLKH	AP-713A	CH-12653 APLKH	AR233	CH-12210 INDUC
AM044902	PF-15680 PRPT	AP-3335	CH-12660 APLKH	AP-3522	CH10-11308 APLKH	AP-744	CH-12660 APLKH	AR234	CH-13150 INDUC
AM044905	CH-12206 PRPT	AP-3335A	CH-12660 APLKH	AP-3522A	CH10-11308 APLKH	AP-795	CH14-12245 APLKH	AR236	CH-13156 INDUC
AM044906	CH-12839 PRPT	AP-3336	CH-12232 APLKH	AP-3523	SC10-11317 APLKH	AP-795A	CH14-12245 APLKH	AR237	CH-13157 INDUC
AM-102746	CH05-12222 JDEER	AP-3336A	CH-12232 APLKH	AP-3523A	SC10-11317 APLKH	AP8047	CH-12208 TECF	AR253	CH06-11038 INDUC
AM-1139	ST06-11315 PURO	AP-3342	PF-15684 APLKH	AP-3524	CH09-12244 APLKH	AP8048	CH-13157 TECF	AR254	CH10-12224 INDUC
AN-150200	CH05-11106 JDEER	AP-3345	CH-12246 APLKH	AP-3524A	CH09-12244 APLKH	AP-839	CH-12235 APLKH	AR256	CH05-11106 INDUC
AN-150-H	CH-11020 VRXH	AP-3347	CH-12385 APLKH	AP-3526	CH-12286 APLKH	AP-839A	CH-12235 APLKH	AR-2710	CH-12386 TECF
AN-153119	ST-14343 JDEER	AP-3347A	CH-12385 APLKH	AP-3526A	CH-12286 APLKH	AP-846	CH-12250 APLKH	AR-39540	CH-12275 JDEER
AP113	PF-15680 WPAC	AP-3350	CH-12247 APLKH	AP-3527	ST09-12265 APLKH	AP-846	CH-16874 APLKH	AR-39797	CH-12275 JDEER

Number Finder



MFRS. NO.	OUR NO. MFR	MFRS. NO.	OUR NO. MFR	MFRS. NO.	OUR NO. MFR	MFRS. NO.	OUR NO. MFR	MFRS. NO.	OUR NO. MFR
AR-39798	CH08-12221 JDEER	ARM-10-9085	SC-12274 A-R	ARM-13-1394	ST08-11110 A-R	ARM-419-K	CH05-12222 A-R	AT-131683	SC14-12254 JDEER
AR-39799	CH-12275 JDEER	ARM-10-9200	CH-12269 A-R	ARM-13-4743	CH-12268 A-R	ARM-46976	CH-14104 A-R	AT175223	CH-16689 JDEER
AR-45669	CH-14104 DEERH	ARM-10-9206	SC-12270 A-R	ARM-13-7178	CH-12268 A-R	ARM-475386	CH-12283 A-R	AT-25981	CH08-12243 JDEER
AR-45943	CH12-11389 JDEER	ARM-11-0022	CH09-12244 A-R	ARM-15-1276	ST-13530 A-R	ARM-475975	CH-12289 A-R	AT-31825	CH05-11106 JDEER
AR-46003	CH12-11389 JDEER	ARM-1113	CH-12214 A-R	ARM-15-3476	ST-13531 A-R	ARM-476769	CH-12213 A-R	AT-33363	CH-12275 JDEER
AR-46004	SC12-11391 JDEER	ARM-1114-1S	CH-12403 A-R	ARM-1553	CH-12231 A-R	ARM-492	CH-12209 A-R	AT-44377	CH08-11003 JDEER
AR-4650	CH-16873 TECF	ARM-1116	CH-12210 A-R	ARM-15-5676	ST-13527 A-R	ARM-505-K	CH06-14733 A-R	AT-44378	ST08-11110 JDEER
AR-4650/1	CH-12235 TECF	ARM-1126	CH14-12245 A-R	ARM-1700	CH-12225 A-R	ARM-510	CH-12209 A-R	AT-45018	CH10-11308 JDEER
AR-46973	CH-14104 JDEER	ARM-11-3341	CH10-11308 A-R	ARM-17064	CH-12262 A-R	ARM-520	CH-12209 A-R	AT-49022	CH14-13356 JDEER
AR-4934	CH-12214 TECF	ARM-11-3343	SC10-12395 A-R	ARM-1740	CH-12091 A-R	ARM-52-2450	CH-12605 A-R	AT-69307	SC-12274 JDEER
AR-4935	CH-13156 TECF	ARM-11-4500	ST06-11315 A-R	ARM-1750	CH-12980 A-R	ARM-6002	CH06-11941 A-R	ATA3559	PF-15683 ATSA
AR502	CH16-12253 INDUC	ARM-11-4747	CH08-12221 A-R	ARM-1753	CH-12386 A-R	ARM-600-K	CH08-12221 A-R	AV-5612	CH10-12224 NPON
AR507	CH14-12245 INDUC	ARM-1163	CH-12397 A-R	ARM-1761	CH-12278 A-R	ARM-60619	CH-12283 A-R	AZ-64724	CH05-11106 FALLI
AR507SY	SC14-12254 INDUC	ARM-11-7092	CH-12282 A-R	ARM-18-1007	CH-12268 A-R	ARM-610-K	CH08-12221 A-R	AY-2011	CH08-12243 ELGS
AR-51923	CH-12257 JDEER	ARM-11-7580	CH-12273 A-R	ARM-18-1033	CH-12262 A-R	ARM-611	CH08-12243 A-R	AZ-18968	CH-12231 JDEER
AR523	CH12-11389 INDUC	ARM-11-7781	SC21-17075 A-R	ARM-18-1034	CH12-11389 A-R	ARM-616-K	CH08-11288 A-R	AZ-20623	CH-12386 JDEER
AR536	CH-12266 INDUC	ARM-11-7782	CH21-17070 A-R	ARM-18-1035	CH12-12251 A-R	ARM-6489T	CH-12212 A-R	AZ-20625	CH09-12244 JDEER
AR-5569	CH-12283 TECF	ARM-11-7797	CH-12268 A-R	ARM-18-1042	CH18-17230 A-R	ARM-711	CH-12275 A-R	AZ-20626	CH-12386 JDEER
AR-64104	CH06-11056 JDEER	ARM-11-8211	CH14-13356 A-R	ARM-18-1044	CH-12269 A-R	ARM-711-K	CH-12275 A-R	AZ-21745	CH10-11308 JDEER
AR-6460	CH-12980 TECF	ARM-11-8216	SC14-13357 A-R	ARM-18-1046	CH14-12245 A-R	ARM-712	CH-13157 A-R	AZ-23644	CH-12232 JDEER
AR-7108	CH-12231 TECF	ARM-11-9135	CH06-11295 A-R	ARM-18-1050	CH05-11106 A-R	ARM-713	CH-13156 A-R	AZ-25498	ST-13530 JDEER
AR-71635	CH06-11056 JDEER	ARM-11-9136	CH08-11288 A-R	ARM-18-1059	CH08-11288 A-R	ARM-716	CH-13150 A-R	AZ-25867	ST09-12265 JDEER
AR-801	ST-16488 TECF	ARM-11-9363	CH08-11288 A-R	ARM-18-1063	CH09-12244 A-R	ARM-722	CH-12271 A-R	AZ-25868	CH09-12244 JDEER
AR-8047	CH-12208 TECF	ARM-11-9410	ST08-11316 A-R	ARM-18-1064	CH10-11308 A-R	ARM-806-K	CH10-11308 A-R	AZ-26007	ST-13527 JDEER
AR-8048	CH-13157 TECF	ARM-11-9538	CH06-14733 A-R	ARM-18-1102	CH-12210 A-R	ARM-8094	CH-12491 A-R	AZ-26091	CH-12242 JDEER
AR-805	ST-16487 TECF	ARM-11-9612	CH10-11308 A-R	ARM-18-1104	CH-12214 A-R	ARM-8095	CH-12485 A-R	AZ-30757	CH-12385 JDEER
AR-820	ST-13531 TECF	ARM-11-9648	CH06-11056 A-R	ARM-18-1126	CH-12403 A-R	ARM-812	CH-12207 A-R	AZ-30758	ST-13531 JDEER
AR-830	ST-13527 TECF	ARM-11-9649	ST-12226 A-R	ARM-2052	CH-12385 A-R	ARM-8155	CH-12867 A-R	AZ45870	SC14-12254 JDEER
AR-840	ST-13529 TECF	ARM-11-9775	CH06-11038 A-R	ARM-2055	CH-12232 A-R	ARM-83121	CH-12215 A-R	AZ48195	CH-12235 JDEER
AR-84228	CH06-11056 JDEER	ARM-11-9778	ST09-12265 A-R	ARM-2080	CH-12236 A-R	ARM-83122	CH-12216 A-R	AZ48196	ST-13529 JDEER
AR-859	SC10-11317 TECF	ARM-12-0022	CH09-12244 A-R	ARM-2301	CH-12242 A-R	ARM-911-K	CH12-12251 A-R	AZA003	CH-12839 COPR
AR-860	ST-13528 TECF	ARM-12-0281	CH05-11467 A-R	ARM-2302	CH-12248 A-R	ARM-912	CH-12208 A-R	AZA003T	CH-12839 COPR
AR-9835	CH-12278 TECF	ARM-12-0307	ST-13410 A-R	ARM-2350	CH-12234 A-R	ARM-99-7064	CH-12225 A-R	AZA004	CH-12206 COPR
ARM-10-0890	CH-12262 A-R	ARM-1204-A	CH-12249 A-R	ARM-2350/1	CH-12242 A-R	ARM-9972	CH-13141 A-R	AZA005	CH-12206 COPR
ARM-1009-2K	CH-12262 A-R	ARM-12-2492	CH08-12243 A-R	ARM-2400	CH-16873 A-R	ARP-15	PF-14090 A-R	AZA008	CH-12177 COPR
ARM-10-1237	CH12-12251 A-R	ARM-12-2510	CH05-11106 A-R	ARM-2401	CH-12235 A-R	ARP-15	PFM-14095 A-R	AZA008T	CH-12177 COPR
ARM-10-1275	CH05-11106 A-R	ARM-12-3160	ST-14343 A-R	ARM-2407	CH-12238 A-R	ARP-188	CH-12206 A-R	AZA009	CH-12212 COPR
ARM-10-2090	CH-12260 A-R	ARM-12-3412	PF-14090 A-R	ARM-260	CH-12491 A-R	ARP-190	CH-12206 A-R	AZA009T	CH-12212 COPR
ARM-10-2745	CH04-11675 A-R	ARM-12-3412	PFM-14095 A-R	ARM-261	CH-12485 A-R	ARP-192	CH-12177 A-R	AZA025	CH-12249 COPR
ARM-10-5043	CH08-12221 A-R	ARM-12-4164	CH08-12228 A-R	ARM-2706	CH-11211 A-R	ARP-2163	CH-11348 A-R	AZA025T	CH-12249 COPR
ARM-10-5054	CH-12275 A-R	ARM-12-4165	ST08-12229 A-R	ARM-2850	CH-12246 A-R	ARP-65	CH-12847 A-R	AZA042	CH-12385 COPR
ARM-10-5368	CH08-11288 A-R	ARM-12-4445	CH06-11295 A-R	ARM-3001	CH-12264 A-R	AS801	ST-16488 TECF	AZA043	CH-12250 COPR
ARM-10-6587	CH12-11389 A-R	ARM-12-4526	SC10-11317 A-R	ARM-3002	CH-12278 A-R	AS805	ST-16487 TECF	AZA043	CH-16874 COPR
ARM-10-6769	CH14-12245 A-R	ARM-12-7532	CH-12276 A-R	ARM-307-K	CH04-11675 A-R	AS810	ST-13530 TECF	AZA043T	CH-12250 COPR
ARM-10-6775	SC14-12254 A-R	ARM-12-7784	CH08-12228 A-R	ARM-320	CH-12272 A-R	AS820	ST-13531 TECF	AZA043T	CH-16874 COPR
ARM-10-6834	SC12-11391 A-R	ARM-12-7787	ST08-12229 A-R	ARM-3322	CH-12247 A-R	AS830	ST-13527 TECF	AZA044	CH-12213 COPR
ARM-10-8668	CH10-11308 A-R	ARM-12-8407	CH18-17230 A-R	ARM-347436	CH-12213 A-R	AS840	ST-13529 TECF	AZA044T	CH-12213 COPR
ARM-10-8674	SC10-11317 A-R	ARM-12-8408	SC18-17232 A-R	ARM-410	CH05-11106 A-R	AS860	ST-13528 TECF	AZA045	PF-15680 COPR
ARM-10-8736	CH05-12222 A-R	ARM-13-0502	CH-12286 A-R	ARM-410-K	CH05-11106 A-R	AT-1131-N	CH05-11106 JDEER	AZA089	CH-12209 COPR

Number Finder



MFRS. NO.	OUR NO. MFR	MFRS. NO.	OUR NO. MFR	MFRS. NO.	OUR NO. MFR	MFRS. NO.	OUR NO. MFR	MFRS. NO.	OUR NO. MFR
AZA098	CH-12209 COPR	AZA328T	SC10-11317 COPR	AZA852	CH-12387 COPR	C 1131	CH-13115 M&H	C16400	CH-16491 M&H
AZA101	CH-12386 COPR	AZA332	CH08-11288 COPR	AZA856	CH-12387 COPR	C 1132	CH-17512 M&H	C-1682	SC-12270 M&H
AZA123	CH-12980 COPR	AZA332T	CH08-11288 COPR	AZA863	CH-12809 COPR	C 1368	CH-13116 M&H	C-17126	SC14-12254 M&H
AZA126	CH-12397 COPR	AZA333	ST08-11316 COPR	AZA885	CH-15300 COPR	C 1633/1	CH-14950 M&H	C17134	CH-12091 M&H
AZA127	CH-12238 COPR	AZA333T	ST08-11316 COPR	AZA894	CH-14107 COPR	C.6150593	CH-16294 PPM	C17149	SC14-12254 M&H
AZA128	CH-12235 COPR	AZA335	ST08-12229 COPR	AZB100	CH-12262 COPR	C1112	CH-12953 M&H	C17201	CH-12285 M&H
AZA128T	CH-12235 COPR	AZA336	CH08-12228 COPR	AZB201	CH-12260 COPR	C11153/1014	CH-12386 CMPR	C17225	CH-12980 M&H
AZA129	CH-12231 COPR	AZA337	CH05-11106 COPR	AZC001	CH05-11106 COPR	C11158/1014	CH-12386 CMPR	C17225/2	CH-12386 M&H
AZA132	CH-12242 COPR	AZA337T	CH05-11106 COPR	AZC002	CH05-11106 COPR	C11158/1041	CH-12242 CMPR	C17225/3	CH-12386 M&H
AZA147	CH-12826 COPR	AZA340	CH08-11288 COPR	AZC005	CH05-11106 COPR	C1140	CH-17541 M&H	C17250	CH-12225 M&H
AZA150	CH-12264 COPR	AZA343	SC14-12254 COPR	AZC054	CH-12653 COPR	C11505-31	CH05-11106 PCLN	C17337	CH08-14410 M&H
AZA151	CH-12660 COPR	AZA343T	SC14-12254 COPR	AZC105	CH08-11288 COPR	C11561724	CH08-11288 CMPR	C18288	CH-12275 M&H
AZA157	CH-12215 COPR	AZA348	CH06-12258 COPR	AZC107	ST08-11316 COPR	C1176/3	CH-12397 M&H	C18436	CH09-12244 M&H
AZA158	CH-12216 COPR	AZA351	CH06-11295 COPR	AZC108	CH08-11288 COPR	C1188	CH05-11106 M&H	C19157	SC-12252 M&H
AZA159	CH-12091 COPR	AZA363	CH04-11675 COPR	AZC109	ST08-12229 COPR	C12100	SC10-11317 M&H	C1989/1	CH-15788 M&H
AZA165	CH05-12222 COPR	AZA364	ST-12226 COPR	AZC110	CH08-12221 COPR	C-12100/1	SC10-11317 M&H	C-20215	SC-12274 M&H
AZA166	CH-12225 COPR	AZA365	CH06-11056 COPR	AZC206	CH10-11308 COPR	C12114	CH-12209 M&H	C20325	CH-12232 M&H
AZA168	CH-12232 COPR	AZA366	CH09-12244 COPR	AZC207	SC10-11317 COPR	C-12119	CH-12209 M&H	C20325/2	CH-12385 M&H
AZA169	CH-12234 COPR	AZA367	ST09-12265 COPR	AZC250	CH12-11389 COPR	C1250	CH-17542 M&H	C20500	CH-16492 M&H
AZA170	CH-12236 COPR	AZA373	CH05-12222 COPR	AZC251	CH12-11389 COPR	C-1258	SC12-11391 M&H	C20550	CH-12286 M&H
AZA171	CH-16873 COPR	AZA374T	SC10-11317 COPR	AZC252	CH12-12251 COPR	C1281	SC12-11391 M&H	C20855	CH-12289 M&H
AZA175	CH-12246 COPR	AZA375	CH-12276 COPR	AZC253	CH12-12251 COPR	C13131	CH-13644 M&H	C20855/1	CH-12289 M&H
AZA176	CH-12247 COPR	AZA376	ST08-11110 COPR	AZC254	CH12-11389 COPR	C13135	CH-12287 M&H	C21338	CH-12236 M&H
AZA177	CH-12248 COPR	AZA376T	ST08-11110 COPR	AZC255	SC12-11391 COPR	C1371	CH-13157 M&H	C21431	CH10-11308 M&H
AZA179T	CH-12752 COPR	AZA386	CH06-11941 COPR	AZC300	CH14-12245 COPR	C1392	CH-12870 M&H	C21630/1	CH-16928 M&H
AZA181	CH-12268 COPR	AZA409	CH-13090 COPR	AZC301	CH14-12245 COPR	C14079	CH04-11675 M&H	C21925	CH-12826 M&H
AZA189	CH-11211 COPR	AZA421	CH-12781 COPR	AZC303	SC14-12254 COPR	C1417	CH-15696 M&H	C-22150	CH-12216 M&H
AZA189T	CH-11211 COPR	AZA430	CH-13050 COPR	AZF003 (AIR)	CH-12839 COPR	C14179/1	CH06-11056 M&H	C22224	CH-12213 M&H
AZA197T	CH-12867 COPR	AZA443	ST-13531 COPR	AZF004 (AIR)	CH-12206 COPR	C14190	CH06-11295 M&H	C-22300	CH-12207 M&H
AZA203	ST-13530 COPR	AZA446	ST-13527 COPR	AZF005	CH-12206 COPR	C1426	CH-11348 M&H	C23326	CH-12208 M&H
AZA203T	ST-13530 COPR	AZA450	ST-13529 COPR	AZF008 (AIR)	CH-12177 COPR	C14490	CH06-11295 M&H	C23440/1	CH-12242 M&H
AZA204	CH-12285 COPR	AZA462	CH-12283 COPR	AZF009 (AIR)	CH-12249 COPR	C15127/1	CH-11789 M&H	C23440/2	CH-12248 M&H
AZA251	CH-12857 COPR	AZA464A	CH-12283 COPR	B03210033	CH05-11106 JCB	C15165/1	CH-12231 M&H	C23440/3	CH-12242 M&H
AZA251T	CH-12857 COPR	AZA485	CH-12953 COPR	B140	CH-12206 T-TJ	C15165/3	CH-12231 M&H	C23500	CH-12234 M&H
AZA309	CH12-11389 COPR	AZA510	CH-12273 COPR	B161	PF-15680 T-TJ	C15248	CH-12809 M&H	C23610	CH-16881 M&H
AZA309T	CH12-11389 COPR	AZA511	SC-12274 COPR	B77	CH-12177 T-TJ	C15300	CH-16490 M&H	C24355	CH-12239 M&H
AZA311	CH12-12251 COPR	AZA511T	SC-12274 COPR	B91	CH-11348 T-TJ	C-1565	CH-12215 M&H	C24393	CH-12825 M&H
AZA311T	CH12-12251 COPR	AZA512	CH-12269 COPR	BBU4784	CH08-11935 LEYL	C16012/52	CH-12285 CMPR	C-24444	CH-12208 M&H
AZA313	CH-12653 COPR	AZA513	SC-12270 COPR	BBU6548	CH-12247 LEYL	C16012052	CH-12285 CMPR	C24444/1	CH-12208 M&H
AZA314	CH14-12245 COPR	AZA514	CH21-17070 COPR	BBU6549	CH-12231 LEYL	C16012189	CH-12385 CMPR	C24508	CH-14107 M&H
AZA314T	CH14-12245 COPR	AZA515	SC21-17075 COPR	BBU6634	CH-12857 LEYL	C16012190	CH-12242 CMPR	C24516	CH12-12251 M&H
AZA319	CH08-11288 COPR	AZA602	CH-12208 COPR	BBU8346	CH-11211 LEYL	C16140	CH-13156 M&H	C24517	CH12-11389 M&H
AZA319T	CH08-11288 COPR	AZA604	CH-13157 COPR	BRH0281	CH08-11288 SUMI	C16147	CH-13141 M&H	C24650	CH-16873 M&H
AZA323T	SC-12252 COPR	AZA608	CH-12207 COPR	BRH0282	ST06-11315 SUMI	C16153	CH-12212 M&H	C24650/1	CH-12235 M&H
AZA324T	CH16-12253 COPR	AZA609	CH-12214 COPR	BRH0575	CH10-11308 SUMI	C16154	CH08-12221 M&H	C24700/1	CH-12238 M&H
AZA326	SC12-11391 COPR	AZA610	CH-13156 COPR	BRH0576	SC10-11317 SUMI	C-16175	CH-13150 M&H	C24719	CH12-11389 M&H
AZA326T	SC12-11391 COPR	AZA611	CH-13150 COPR	BRP0027	CH12-11389 SUMI	C16190/1	CH08-12243 M&H	C24813	CH-15300 M&H
AZA327	CH10-11308 COPR	AZA612	CH-12210 COPR	BRP0028	SC12-11391 SUMI	C16247/1	CH-14387 M&H	C24870	CH-12276 M&H
AZA328	SC10-11317 COPR	AZA815	CH-12278 COPR	C 11 100	CH-16878 M&H	C16302	CH08-11288 M&H	C25710/3	CH-16969 M&H

Number Finder



MFRS. NO.	OUR NO. MFR	MFRS. NO.	OUR NO. MFR	MFRS. NO.	OUR NO. MFR	MFRS. NO.	OUR NO. MFR	MFRS. NO.	OUR NO. MFR
C26315/4	CH-12660 M&H	CA-1531SY	ST-13410 FRAM	CA-3271	CH-12250 FRAM	CA-4838	CH-12235 FRAM	CA-6916SY	ST08-12229 FRAM
C271406	CH-11211 M&H	CA-1543SY	ST06-11315 FRAM	CA-3271	CH-16874 FRAM	CA-4893	CH-12387 FRAM	CA-6918	CH-11020 FRAM
C271520	CH-11211 M&H	CA-1544SY	ST08-11316 FRAM	CA-3276	CH-12242 FRAM	CA-4919	CH-12857 FRAM	CA-6922	CH-12213 FRAM
C-27836	CH-12269 M&H	CA-1569	CH14-13356 FRAM	CA-3276SY	ST-13527 FRAM	CA-4920	CH-13050 FRAM	CA-7088	CH-12716 FRAM
C2860	PF-15684 M&H	CA-1569SY	SC14-13357 FRAM	CA-3277	CH-12248 FRAM	CA-4929	CH-13050 FRAM	CA-7111	CH-12386 FRAM
C28715	CH-12246 M&H	CA-1570	CH21-17070 FRAM	CA-3280	CH-12235 FRAM	CA-4942	CH-11211 FRAM	CA-7137SY	SC10-12395 FRAM
C28750	CH-12798 M&H	CA-1570SY	SC21-17075 FRAM	CA-3280SY	ST-13529 FRAM	CA-4947	CH-12289 FRAM	CA-7178	CH-12234 FRAM
C29 624/1	CH-12214 M&H	CA-1581	CH-12268 FRAM	CA-3281	CH-12385 FRAM	CA-4948	CH-12283 FRAM	CA-7178	CH-12242 FRAM
C291055	CH-15294 M&H	CA-1589	ST-12226 FRAM	CA-3281SY	ST-13531 FRAM	CA-4962	CH-12231 FRAM	CA-7179	CH-12232 FRAM
C-29624	CH-12214 M&H	CA-163PL	PF-14090 FRAM	CA-3283	CH-12653 FRAM	CA-5022	CH-12386 FRAM	CA-7201	CH-12604 FRAM
C-29776	CH-12210 M&H	CA-163PL	PFM-14095 FRAM	CA-3290-A	CH-12235 FRAM	CA-5026SY	CH05-11467 FRAM	CA-7201SY	CH-12605 FRAM
C-29920	CH14-12245 M&H	CA-216	CH-12207 FRAM	CA-3291-A	CH-12232 FRAM	CA-5027	CH-12271 FRAM	CA-7211SY	ST-13527 FRAM
C29939	CH14-12245 M&H	CA-224	CH-12208 FRAM	CA-3291-SY	ST-13531 FRAM	CA-507	CH14-12245 FRAM	CA-7242	CH-12397 FRAM
C301240	CH-14896 M&H	CA-226	CH-12214 FRAM	CA-3295	CH-12231 FRAM	CA-507SY	SC14-12254 FRAM	CA-7244	CH-12231 FRAM
C301353	CH-14900 M&H	CA-226SY	CH-13141 FRAM	CA-3295-SY	ST-16487 FRAM	CA-508	CH-12275 FRAM	CA-7431	CH-12272 FRAM
C301500	CH-14902 M&H	CA-229	CH-12209 FRAM	CA-3307	CH-12847 FRAM	CA-5155	CH-12283 FRAM	CA-7458	CH-12091 FRAM
C30703	CH-12387 M&H	CA-233	CH-12210 FRAM	CA-3441	PF-15684 FRAM	CA-5176	CH-12498 FRAM	CA-7458SY	ST-16879 FRAM
C30810/3	CH-16971 M&H	CA-234	CH-13150 FRAM	CA-3559	PF-15683 FRAM	CA-521	CH-12249 FRAM	CA-7459	CH-12225 FRAM
C30850/2	CH-12278 M&H	CA-236	CH-13156 FRAM	CA-3660	PF-15684 FRAM	CA-5222	CH-11789 FRAM	CA-7467	CH-12276 FRAM
C30880/1	CH-12264 M&H	CA-237	CH-13157 FRAM	CA-3794	CH-12268 FRAM	CA-523	CH12-11389 FRAM	CA-7470SY	ST06-12048 FRAM
C31 1256	CH-15304 M&H	CA-244	CH-12260 FRAM	CA-3907	CH-12953 FRAM	CA-5232	CH12-11343 FRAM	CA-7490	CH-12403 FRAM
C311093	CH-12283 M&H	CA-244-1	CH-12260 FRAM	CA-4200	CH-12232 FRAM	CA-5232	CH-13477 FRAM	CA-7670	CH-14722 FRAM
C311093/1	CH-12283 M&H	CA-252	CH-12262 FRAM	CA-4202	CH-12386 FRAM	CA-523SY	SC12-11391 FRAM	CA-7670SY	ST-14715 FRAM
C311093/2	CH-12283 M&H	CA-252-1	CH-12262 FRAM	CA-4202-SY	ST-13530 FRAM	CA-5321SY	ST-13528 FRAM	CA-7675	CH-12282 FRAM
C311226	CH16-12253 M&H	CA-2521SY	ST-12226 FRAM	CA-4203	CH-12236 FRAM	CA-534	CH-12271 FRAM	CA-7687SY	ST08-12229 FRAM
C311226/1	CH-15300 M&H	CA-2523SY	ST09-12265 FRAM	CA-4205	CH-12234 FRAM	CA-534SY	CH-12272 FRAM	CA-7690	CH08-11942 FRAM
C311495	CH-16922 M&H	CA-2524	CH06-11056 FRAM	CA-4208	CH-12238 FRAM	CA-535	CH-12273 FRAM	CA-7691	CH-12285 FRAM
C31220	CH-12249 M&H	CA-2557SY	ST-14343 FRAM	CA-4209	CH-12247 FRAM	CA-535SY	SC-12274 FRAM	CA-7709	CH-14237 FRAM
C331476	CH-13763 M&H	CA-256	CH05-11106 FRAM	CA-4210	CH-12980 FRAM	CA-5364	CH-13763 FRAM	CA-7712	CH-12980 FRAM
C331605	CH-12282 M&H	CA-2573	CH-12286 FRAM	CA-4212	CH-12246 FRAM	CA-5368	CH-12825 FRAM	CA-7712SY	ST-13530 FRAM
C33922	CH-12247 M&H	CA-258SY	ST08-11110 FRAM	CA-4214	CH-12826 FRAM	CA-541	CH-12403 FRAM	CAK-1531	CH05-11467 FRAM
C34430	CH-12250 M&H	CA-2595	CH18-17230 FRAM	CA-4215	CH-12278 FRAM	CA-5435	PF-15690 FRAM	CAK-1532	CH06-14733 FRAM
C34430	CH-16874 M&H	CA-2595SY	SC18-17232 FRAM	CA-4216	CH-12225 FRAM	CA-5453	CH-13185 FRAM	CAK-1544	CH08-11288 FRAM
C45 3265	CH21-17070 M&H	CA-2611	CH-12177 FRAM	CA-4219	CH-12285 FRAM	CA-5455SY	ST-14787 FRAM	CAK-1563	CH05-11106 FRAM
C-46155	CH08-12243 DAVEY	CA-2612	CH-12215 FRAM	CA-4221	CH-12264 FRAM	CA-546SY	SC10-11317 FRAM	CAK-2521	CH06-11056 FRAM
C5NE-9A641-#	CH-12209 FORD	CA-265	CH-12262 FRAM	CA-4276	CH-12276 FRAM	CA-5521	CH-12953 FRAM	CAK-2523	CH09-12244 FRAM
C60148	PF-15688 M&H	CA-2650	CH-12212 FRAM	CA-4277	CH-12283 FRAM	CA-559	CH14-12245 FRAM	CAK-255	CH12-12251 FRAM
C60230	PF-15690 M&H	CA-266SY	CH-13141 FRAM	CA-4278	CH-11211 FRAM	CA-5590	PF-15686 FRAM	CAK-256	CH05-11106 FRAM
C60345	PF-15693 M&H	CA-2700	CH-12249 FRAM	CA-4300	CH-12397 FRAM	CA-563	CH-12269 FRAM	CAK-3272	CH06-11295 FRAM
C630	CH-17539 M&H	CA-3105SY	ST-16488 FRAM	CA-4337	CH-12289 FRAM	CA-563SY	SC-12270 FRAM	CAK-352	CH04-11675 FRAM
C6JZ-9600-B	CH08-12243 FORD	CA-3194	CH-12278 FRAM	CA-4362	CH-12282 FRAM	CA-586	CH-14104 FRAM	CAK-3819	CH10-11308 FRAM
C7178	CH-12242 FRAM	CA-3201	CH-12216 FRAM	CA-4584	CH-12809 FRAM	CA-5872	CH-16689 FRAM	CAK-4298	CH06-12258 FRAM
C7JZ-9600-C	CH08-12243 FORD	CA-3224	CH-12213 FRAM	CA-4666	CH-14107 FRAM	CA-597	CH-12268 FRAM	CAK-4361	CH08-12228 FRAM
C7NN-9A641-#	CH-12209 FORD	CA-3224A	CH-12213 FRAM	CA-4684-SY	ST-13529 FRAM	CA-6317	CH-12234 FRAM	CAK-4414	CH09-12244 FRAM
C7NN-9A641-C	CH-12209 FORD	CA-3227	CH-12660 FRAM	CA-4685-SY	ST-13527 FRAM	CA-6526	CH-12249 FRAM	CAK-4817	CH08-11935 FRAM
C7TA-9600-G	CH10-11308 FORD	CA-3227A	CH-12660 FRAM	CA-4686	CH-12980 FRAM	CA-663PL	CH-11348 FRAM	CAK-5050S	CH08-12243 FRAM
C8TZ-9601-C	CH10-11308 FORD	CA-3249	CH-12091 FRAM	CA-4771	CH-12781 FRAM	CA-6666	CH-14107 FRAM	CAK-5052S	CH05-11106 FRAM
CA-1507-SY	SC21-17075 FRAM	CA-3261	CH10-12224 FRAM	CA-4772SY	CH-12867 FRAM	CA-667PL	CH-12839 FRAM	CAK-508	CH-12275 FRAM
CA-1527	CH-12209 FRAM	CA-3262	CH10-11308 FRAM	CA-4812	CH-14334 FRAM	CA-681PL	CH-12953 FRAM	CAK-510	CH08-12221 FRAM

Number Finder



MFRS. NO.	OUR NO. MFR	MFRS. NO.	OUR NO. MFR	MFRS. NO.	OUR NO. MFR	MFRS. NO.	OUR NO. MFR	MFRS. NO.	OUR NO. MFR
CAK-530	CH04-11675 FRAM	CF810	ST-16972 M&H	CFM816	CH-12242 CFM	CS19175	CH-13889 M&H	D-99737	CH12-11389 GLN
CAK-546	CH10-11308 FRAM	CF811	ST-16876 M&H	CFM822	CH-12235 CFM	CS19195	CH-13190 M&H	D-99739	SC12-11391 GLN
CAK-5520	CH08-14835 FRAM	CF820	ST-16879 M&H	CFM84	CH-12210 CFM	CUA616	CH-12206 HRMO	DA551/4	CH-12177 GE
CAK-553	CH05-12222 FRAM	CF821	ST-16879 M&H	CFM85	CH-13150 CFM	CUA618	CH-12839 HRMO	DDX-18911	CH08-11942 JDEER
CAK-5568	CH10-12390 FRAM	CF840	ST-12226 M&H	CFM852	PF-14090 CFM	CUA755	CH10-11308 HRMO	DDX-18913	CH-12798 JDEER
CAK-5568	CH10-14455 FRAM	CF922	ST08-11316 M&H	CFM852	PFM-14095 CFM	CUA788	CH12-12251 HRMO	DGM/L 01128	ST-14343 DIGO
CAK-565	CH08-11288 FRAM	CF923	ST06-11315 M&H	CFM884	CH18-17230 CFM	CUAF418M	CH12-11389 KOMD	DGMMO1378K	CH04-11675 DIGO
CAK-565A	CH08-11288 FRAM	CF924	ST08-11110 M&H	CFM885	SC18-17232 CFM	CUAF490M	SC12-11391 KOMD	DGMO1378K	CH04-11675 DIGO
CAK-6916	CH08-12228 FRAM	CFM1003	CH05-11467 CFM	CFM946	CH-12216 CFM	CV 20948	CH-16689 PRKN	DL9601A	CH10-12224 FORD
CAK-7082	CH-13270 FRAM	CFM101F	CH12-12251 CFM	CFM948	CH-12215 CFM	CV4170	CH14-12245 RR	DO55379	CH-12397 BOSS
CAK-7109	CH06-11941 FRAM	CFM132	CH-12206 CFM	CFM98	CH-12262 CFM	CV4180	CH12-11389 RR	DOX18913	CH-12798 JDEER
CAK-7324	CH-12770 FRAM	CFM134F	CH05-11106 CFM	CFM982	CH-12091 CFM	CV507	CH-15300 RR	DP60533-2	ST-14787 CMPR
CAK-7468	CH06-11295 FRAM	CFM142	CH-12209 CFM	CFM986	CH-16873 CFM	CV-9685	CH-15300 RR	DO08521	CH-12242 JDEER
CAK-7687	CH08-12228 FRAM	CFM2006	CH-12278 CFM	CH-12767	CH05-11106 JDEER	D.6150594	SC-16301 PPM	DO08522	ST-13527 JDEER
CAK-7702	CH06-11880 FRAM	CFM202	PF-15677 CFM	CH-15451	CH04-11675 JDEER	DO55379	CH-12397 BOSST	DRM-6200-HD	CH-12262 SHRM
CD 2502	CH10-11308 CPRH	CFM208F	CH-12275 CFM	CH18287	CH08-11288 JDEER	DOHZ-9601-G	CH14-12245 FORD	DT-0890	CH-12262 WIX
CD 2504	CH10-11308 CPRH	CFM237	CH-12249 CFM	CK-8849-1	CH-12262 WBCO	DOJJ-9600-B	CH08-12243 FORD	DT-1237	CH12-12251 WIX
CD016255028	CH-12867 AIRM	CFM249	SC14-12254 CFM	CL677434-C0	CH-12385 M-F	D0NN-9B618-E	CH-12209 FORD	DT-1275	CH05-11106 WIX
CD061550283	CH-12867 AIRM	CFM286	CH14-12245 CFM	CLE-371	CH05-11106 WOPU	D-103258	CH14-12245 GLN	DT-17064	CH-12262 WIX
CD061550683	CH-12867 AIRM	CFM361	CH-12269 CFM	CLE-390	CH09-12244 WOPU	D-103259	SC14-12254 GLN	DT-2090	CH-12260 WIX
CD0615610-83	CH-12867 AIRM	CFM385	CH12-11389 CFM	CM-921	CH08-12243 P-M	D-106576	CH10-11308 GLN	DT-42	PF-14090 WIX
CD122180582	CH-12781 AIRM	CFM421F	CH10-11308 CFM	CM-94	CH05-11106 P-M	D106587	CH12-11389 HTCH	DT-42	PFM-14095 WIX
CD1302	CH05-11106 CPRH	CFM432	SC12-11391 CFM	CM-94	CH05-11106 WHITE	D-114359	CH08-12243 GLN	DT-8047	CH-12208 WIX
CD1304	CH05-11106 CPRH	CFM434	SC10-11317 CFM	CNA-3559	PF-15683 CNCO	D-115548	CH04-11675 GLN	DT-8048	CH-13157 WIX
CD2002	CH08-11288 CPRH	CFM435	SC-12274 CFM	CP-4N0015	PF-14090 UEL	D-119394	CH05-11106 GLN	DT-9045	CH-12210 WIX
CD2004	CH08-11288 CPRH	CFM437	CH-12269 CFM	CP-4N0015	PFM-14095 UEL	D2JL-9600-B	CH10-11308 FORD	DT-9046	CH-13150 WIX
CD3002	CH12-11389 CPRH	CFM538	CH-13141 CFM	CP-6L4714	PF-15677 UEL	D2JL-9600-B 1	SC10-11317 FORD	DT-9334	CH-12214 WIX
CD3004	CH12-11389 CPRH	CFM573F	CH08-12221 CFM	CPD7012	CH-12867 VAPOR	D-40349	CH05-11106 CASE	DT-9335	CH-13156 WIX
CD3502	CH14-12245 CPRH	CFM574	CH21-17070 CFM	CPD7015	CH-12485 VAPOR	D-43712	CH05-11106 CASE	DT-9378	CH-12207 WIX
CD3504	CH14-12245 CPRH	CFM601F	CH06-14733 CFM	CPD7026	CH06-11056 VAPOR	D-48198	CH05-11106 CASE	DU1206S	CH12-11389 COPR
CF100	ST-16877 M&H	CFM608	CH-12273 CFM	CPD7029	CH-12275 VAPOR	D-53106	CH05-11106 CASE	DU-1206T	CH12-11389 DON
CF1000	ST-13531 M&H	CFM617	SC21-17075 CFM	CPD7038	ST-16487 VAPOR	D-55164	CH05-11106 CASE	DU1206TS	CH12-11389 COPR
CF1122	ST09-12265 M&H	CFM632F	CH06-11056 CFM	CPD7040	ST-13530 VAPOR	D-55203	CH05-11106 CASE	DU-1233	CH12-12251 DON
CF1200	ST-13527 M&H	CFM641	CH14-13356 CFM	CPD7078	SC10-11317 VAPOR	D-55864	CH08-11288 CASE	DU1233S	CH12-12251 COPR
CF1300	ST-13529 M&H	CFM642	SC14-13357 CFM	CPD7124	CH08-11288 VAPOR	D-56453	CH08-11288 CASE	DU1233TS	CH12-12251 COPR
CF1600	ST-13528 M&H	CFM644F	CH05-11467 CFM	CPD7129	ST-13527 VAPOR	D-56463	CH08-11288 CASE	DU1260S	CH-12260 COPR
CF200	ST-16493 M&H	CFM690F	CH08-11288 CFM	CPD7141	CH-13075 VAPOR	D-58544-A	CH-12262 CECCO	DU1454	CH-12653 COPR
CF2100	ST-17470 M&H	CFM75	CH-12260 CFM	CPD7143	SC10-12395 VAPOR	D600689	CH04-11675 BOSS	DU1518S	CH14-12245 COPR
CF300	ST-16494 M&H	CFM76	CH-12208 CFM	CPD7150	CH12-11343 VAPOR	D-60382	CH-12262 GLN	DU-1518T	CH14-12245 DON
CF-3441	PF-15684 FIRES	CFM77	CH-13157 CFM	CPD7150	CH-13477 VAPOR	D-73913	CH-12262 GLN	DU1518TS	CH14-12245 COPR
CF-3575	PF-15683 FIRES	CFM773	CH-12271 CFM	CPD7152	CH-12790 VAPOR	D-73914	CH-12262 GLN	DU1705T	CH08-11288 COPR
CF400	ST-16495 M&H	CFM777F	CH09-12244 CFM	CPD7157	CH-12980 VAPOR	D-74314	CH-12262 GLN	DU2222	CH08-11288 COPR
CF500	ST-16496 M&H	CFM78	CH-12214 CFM	CPD7177	CH-12500 VAPOR	D-79041	CH12-12251 GLN	DU2231	ST08-11316 COPR
CF600	ST-16488 M&H	CFM782F	CH05-11106 CFM	CPD7178	CH-12279 VAPOR	D-82571	CH04-11675 CASE	DU-2353.T	ST08-12229 DON
CF610	ST-16875 M&H	CFM79	CH-13156 CFM	CPD7233	CH06-14733 VAPOR	D-82775	ST-13410 CASE	DU2354	CH08-12228 COPR
CF700	ST-16487 M&H	CFM791	CH-12385 CFM	CPD7244	CH-12794 VAPOR	D-84371	CH10-12224 GLN	DU-2354	CH08-12228 DON
CF710	ST-16970 M&H	CFM799	CH-11020 CFM	CPM8006	PF-15688 VAPOR	D911519	CH12-11389 HTCH	DU2399	CH05-11106 COPR
CF711	ST-16880 M&H	CFM80	CH-12207 CFM	CRF508027	CH12-11389 LEYL	D911762	CH12-12251 HTCH	DU345S	CH-12262 COPR
CF800	ST-13530 M&H	CFM813	CH-12386 CFM	CS18106	CH-13939 M&H	D914453	SC12-11391 HTCH	DU-664	CH05-11106 DON

Number Finder



MFRS. NO.	OUR NO. MFR	MFRS. NO.	OUR NO. MFR	MFRS. NO.	OUR NO. MFR	MFRS. NO.	OUR NO. MFR	MFRS. NO.	OUR NO. MFR
DU664S	CH05-11106 COPR	E118LS	ST-13528 HGST	E70210052	CH05-11106 SXB	EBB-12-0070	CH-12214 DONH	EFA324	CH-12247 MOTR
DU664TS	CH05-11106 COPR	E120L	CH-12285 HGST	E70210066	ST06-11315 SXB	ECB08-5001	DL-16550 DON	EFA325	CH-12246 MOTR
DU-770CT	CH08-11003 DON	E124398	ST-13531 CAL	E70210067	CH06-11295 SXB	ECB08-5011	DL-16560 DON	EFA327	CH14-12245 MOTR
DU-770T	CH08-11003 DON	E12505-60	CH-12214 PCLN	E70210071	CH08-11288 SXB	ECB08-5024	DL-16862 DON	EFA328	CH-12278 MOTR
DU-879/2	CH10-12224 DON	E127L	CH-11211 HGST	E70210077	CH08-11288 SXB	ECB08-5034	DL-16859 DON	EFA329	CH-12283 MOTR
DU-879T	CH10-12224 DON	E149L	CH-12980 HGST	E70210078	ST08-11316 SXB	ECB08-5056	DL-17114 DON	EFA330	CH-11211 MOTR
DX0143/1	CH-12870 DMND	E150L	CH-12232 HGST	E70211103	CH10-11308 SXB	ECB10-0094	DL-17163 DON	EFA333	PF-15680 MOTR
DX1722	CH-12980 DMND	E151L	CH-15788 HGST	E70211401	SC10-11317 SXB	ECB10-5006	DL-16141 DON	EL1165	CH-12262 LTR
DX211	CH-13141 DMND	E199L	PF-15690 HGST	E70211501	CH-12266 SXB	ECB10-5013	DL-16864 DON	EL1354	CH-12209 LTR
DX214	CH-13157 DMND	E209L	PF-15693 HGST	E70211703	CH12-11389 SXB	ECB12-0439	DL-17111 DON	EL1357	CH-12209 LTR
DX215	CH-13156 DMND	E211-2103	CH10-11308 HYUN	E70211803	CH09-12244 SXB	ECB12-5011	DL-15751 DON	EL1684S	SC06-11252 LTR
DX2319	CH-12209 DMND	E218L	CH-12387 HGST	E70211804	ST09-12265 SXB	ECC06-5001	DL-17710 DON	EL1780S	CH-12485 LTR
DX302	CH-12386 DMND	E-230115	CH08-12243 AMHO	E70211902	SC14-12254 SXB	ECC06-5003	DL-17330 DON	EL1781P	CH-13510 LTR
DX307	CH-12397 DMND	E237L	CH-14900 HGST	E70211905	CH14-12245 SXB	ECC08-5001	DL-17333 DON	EL1781S	CH-13520 LTR
DX3088	CH-12264 DMND	E2750574	ST-13529 PCLN	E70212061	CH06-11295 SXB	ECC08-5002	DL-17331 DON	EL2106P	CH-12491 LTR
DX309	CH-12225 DMND	E275L	CH-12246 HGST	E725047003	CH05-11106 LANLI	ECC08-5004	DL-17329 DON	EL2106S	CH-12485 LTR
DX311	CH-12285 DMND	E276L	CH-12247 HGST	E7410157	CH04-11675 PLJOB	ECC08-5035	DL-17852 DON	EL2107P	CH-12500 LTR
DX3126	CH-12207 DMND	E277L	CH-12091 HGST	E7415256	CH05-14409 PLJOB	ECC10-5003	DL-17823 DON	EL2107S	CH-12279 LTR
DX315	CH-13150 DMND	E278L	CH-12225 HGST	E76L	CH-11348 HGST	ECC10-5004	DL-17335 DON	EL2134P	CH-14340 LTR
DX3760	CH-12249 DMND	E278LS	ST-16876 HGST	E9NN-9B618-E	CH-14722 FORD	ECC12-50004	DL-17336 DON	EL2134S	CH-14334 LTR
DX380	CH-12273 DMND	E280L	CH-12236 HGST	E9NN-9R500-A	ST-14715 FORD	ECC06-5008	DL-17332 DON	EL2151P	CH-12498 LTR
DX381	SC-12274 DMND	E282L	CH-12238 HGST	EAF5002	CH16-12253 DON	ECG-13-0005	CH-12268 DONH	EL3049	CH12-11389 LTR
DX3842	CH-12216 DMND	E283L	CH-12264 HGST	EAF5034	CH12-11389 DON	ECG-15-0001	CH-12282 DONH	EL3051	CH12-12251 LTR
DX3843	CH-12215 DMND	E285L	CH-12809 HGST	EAF5039	CH-12266 DON	ECG-15-0010	CH-12282 DONH	EL3053	CH05-11106 LTR
DX395	CH-12826 DMND	E286L	CH-12234 HGST	EAF5040	CH21-17070 DON	ED03013	ST08-12229 AIRM	EL3054	CH14-12245 LTR
DX4043	CH-12248 DMND	E288L	CH-12250 HGST	EAF5041	CH-12273 DON	EDC032	CH-12273 DVRI	EL3065	CH-12208 LTR
DX610	CH-12208 DMND	E288L	CH-16874 HGST	EAF5042	CH18-17230 DON	EFA120	CH-11348 MOTR	EL3083	CH-12385 LTR
DX613	CH-12214 DMND	E289L	CH-12660 HGST	EAF5044	CH-12269 DON	EFA152	CH-11348 MOTR	EL3084	CH-12235 LTR
DX674	CH-12262 DMND	E291L	CH-12283 HGST	EAF5046	CH14-12245 DON	EFA225	CH06-12258 MOTR	EL3085	CH-12248 LTR
E02505-67	CH06-11295 PCLN	E-380069	CH-12260 AMHO	EAP3518	PF-15690 COPR	EFA228	CH-12397 MOTR	EL3086	CH-12242 LTR
E025505-66	ST06-11315 PCLN	E-380069	CH-12260 BROS	EBA-13-0017	CH-12268 DONH	EFA234	CH12-11389 MOTR	EL3087	CH-12386 LTR
E08505-68	CH-12273 PCLN	E-41535	ST06-11109 CASE	EBA-13-0018	CH-12268 DONH	EFA264	CH12-11389 MOTR	EL3089	CH-16873 LTR
E100267	CH-12980 CAL	E-43780	CH06-11038 CASE	EBA-13-0023	CH-12268 DONH	EFA300	CH05-11106 MOTR	EL3090	CH-12213 LTR
E100880	CH-12385 CAL	E50-0075	CH-12653 DON	EBA-13-0024	CH-12268 DONH	EFA304	CH-12231 MOTR	EL3091	CH-12250 LTR
E101225	CH-12386 CAL	E50-0150	CH05-11106 DON	EBA-13-0025	CH-12268 DONH	EFA306	CH08-11288 MOTR	EL3091	CH-16874 LTR
E10505-06	SC21-17075 PCLN	E50-0667	CH05-11555 DON	EBA-13-0026	CH-12268 DONH	EFA307	CH-12980 MOTR	EL3304P	CH-12491 LTR
E111L	CH-12397 HGST	E50-1042	CH06-11056 DON	EBA-13-0027	CH-12268 DONH	EFA308	CH-12386 MOTR	EL3304S	CH-12485 LTR
E112LS	ST-16488 HGST	E59Z-9601-A	PF-15684 FORD	EBA-13-0028	CH-12268 DONH	EFA309	CH09-12244 MOTR	EL502N	CH-12953 KNCT
E113L	CH-12231 HGST	E59Z9601AA	PF-15684 FORD	EBA-13-0034	CH-12268 DONH	EFA310	CH-12232 MOTR	ELM-43	CH-12262 WOPU
E114L	CH-12386 HGST	E6050036	CH05-11106 PLJOB	EBA-13-0035	CH-12268 DONH	EFA311	CH-12385 MOTR	ELM-44	CH05-11106 WOPU
E114LS	ST-13530 HGST	E62-2511	CH-12260 EUC	EBA-13-0045	CH-12268 DONH	EFA313	CH-12213 MOTR	ELM-54	CH10-11308 WOPU
E115L	CH-12385 HGST	E63-2878	CH-12260 EUC	EBA-13-0049	CH-12268 DONH	EFA315	CH-12242 MOTR	ELM-56	SC10-11317 WOPU
E115LS	ST-13531 HGST	E69E-9601-AA	PF-15684 FORD	EBA-13-0051	CH-12268 DONH	EFA316	CH-12248 MOTR	ELM-74	ST08-11316 WOPU
E116L	CH-12242 HGST	E6NN-9B618-A	CH-12209 FORD	EBA-13-0054	CH-12268 DONH	EFA317	CH12-12251 MOTR	ELM-78	CH09-12244 WOPU
E116L01	CH-12248 HGST	E70-0119	CH08-11288 DON	EBA-13-0056	CH-12268 DONH	EFA318	CH-16873 MOTR	ELM-79	ST09-12265 WOPU
E116LS	ST-13527 HGST	E70-0127	CH06-11295 DON	EBA-13-0064	CH-12268 DONH	EFA319	CH-12235 MOTR	ELM-85	CH04-11675 WOPU
E117207	CH-12231 CAL	E70154329	CH-15294 SXB	EBA-13-5000	CH-12268 DONH	EFA320	CH-12238 MOTR	EMP-67	CH05-11106 P-M
E117L	CH-12235 HGST	E70154330	CH-12507 SXB	EBA-15-0004	CH-12282 DONH	EFA321	CH-12660 MOTR	EP-78	CH05-11106 WISC
E118L	CH-12278 HGST	E70210046	CH08-11288 SXB	EBA-15-0012	CH-12268 DONH	EFA323	CH-12264 MOTR	F02505-66	ST06-11315 PCLN

Number Finder



MFRS. NO.	OUR NO. MFR	MFRS. NO.	OUR NO. MFR	MFRS. NO.	OUR NO. MFR	MFRS. NO.	OUR NO. MFR	MFRS. NO.	OUR NO. MFR
F02505-90	CH-12231 PCLN	FA1462	CH-13939 PMTC	FA-525	CH-13157 MOTR	FAC982	CH-12231 FSPA	FCA-3025	CH14-12245 SOPR
F025505-67	CH06-11295 PCLN	FA-150	CH-12275 MOTR	FA-534	CH-12260 MOTR	FAC984	CH-12302 FSPA	FCA-3160	CH-12213 SOPR
F08505-45	ST-13531 PCLN	FA1566	CH-15304 PMTC	FA-536	CH-12207 MOTR	FAC985	CH-12248 FSPA	FCA-3161	CH-12660 SOPR
F08505-68	CH-12273 PCLN	FA1569	CH-15294 PMTC	FA-564	CH10-11308 MOTR	FAC986	ST-13527 FSPA	FCA-3162	CH-12250 SOPR
F09917881	CH12-12251 FALLI	FA-157	CH04-11675 MOTR	FA-565	CH12-11389 MOTR	FAC988	CH14-12245 FSPA	FCA-3162	CH-16874 SOPR
F10505-07	CH21-17070 PCLN	FA-158	SC12-11391 MOTR	FA-601	CH-12268 MOTR	FAC989	CH-12235 FSPA	FCA-3201	SC12-11391 SOPR
F12505-61	CH-13156 PCLN	FA-176	CH08-11288 MOTR	FA-616	CH-13141 MOTR	FAC990	CH05-11106 FSPA	FCA-3205	CH-12980 SOPR
F13520109002	CH-12397 FNDD	FA-185	SC14-12254 MOTR	FA-619	CH-12177 MOTR	FAC992	CH10-12224 FSPA	FCA-3206	CH08-11288 SOPR
F13520309201	CH-12091 FNDD	FA-186	CH05-12222 MOTR	FA-631	CH14-13356 MOTR	FAC993	SC14-12254 FSPA	FCA-3207S	ST08-11316 SOPR
F17526	CH08-12243 FRM	FA-188	CH12-11389 MOTR	FA-632	SC14-13357 MOTR	FAC995	CH-12213 FSPA	FCA-3258	CH-12247 SOPR
F17820009001	CH-12231 FNDD	FA-190	SC-12274 MOTR	FA-648	CH-12273 MOTR	FAC996	CH-11211 FSPA	FCA-3259	CH-12246 SOPR
F17820009002	ST-16487 FNDD	FA2100	PF-15672 LTR	FA-663	ST06-11315 MOTR	FAC999	SC12-11391 FSPA	FCA-3285	CH-12498 SOPR
F17881014001	PF-15688 FNDD	FA-211	SC10-12395 MOTR	FA-735	CH-13157 MOTR	FAF-104	CH-12208 HAST	FCA-3287	SC06-11252 SOPR
F18220009001	CH-12386 FNDD	FA-232	CH08-12221 MOTR	FA-738	CH09-12244 MOTR	FAF-108	CH-12214 HAST	FCA-3306	SC10-11317 SOPR
F18420009001	CH-12386 FNDD	FA-233	SC10-11317 MOTR	FA-740	PF-15677 MOTR	FAF-133K	CH05-11106 HAST	FCA-3307	CH06-11295 SOPR
F18420009004	ST-13530 FNDD	FA-235	CH-12269 MOTR	FA-752	PF-15684 MOTR	FAF-245K	CH10-11308 HAST	FCA-3308	CH-12276 SOPR
F18423009005	CH-12385 FNDD	FA-247	CH-12209 MOTR	FA-756	CH21-17070 MOTR	FAF-323	CH-12268 HAST	FCA-3309	ST06-11315 SOPR
F18423009010	ST-13531 FNDD	FA-270	CH-14104 MOTR	FA-772	CH-12272 MOTR	FAF-4563	CH-12268 PAI	FCA-3310	ST09-12265 SOPR
F18620009101	CH-12980 FNDD	FA-295	SC-12270 MOTR	FA-779	CH-12282 MOTR	FAF-97K	CH12-12251 HAST	FCA-3311	CH-12091 SOPR
F19820009001	CH-12386 FNDD	FA-296	CH-12273 MOTR	FA-798	CH-12206 MOTR	FC102	CH-12232 DTX	FCA-3312	CH-12225 SOPR
F19881014001	PF-15688 FNDD	FA3107	CH-14107 PMTC	FA-805	SC21-17075 MOTR	FC103	CH10-11308 DTX	FCA-3313	CH-12269 SOPR
F20520009101	ST-16488 FNDD	FA3113	CH-12809 PMTC	FA-810	CH08-11288 MOTR	FC104	CH12-11389 DTX	FCA-3314	SC-12270 SOPR
F-227F-50	CH05-11106 GRYM	FA3116	CH-12093 PMTC	FA-816	CH05-11467 MOTR	FC105	CH-12386 DTX	FCA-3315	CH09-12244 SOPR
F-227F-502	CH05-11106 CNTL	FA3121	CH-13763 PMTC	FA-822	CH06-14733 MOTR	FC106	CH-12385 DTX	FCA-3321	ST-13527 SOPR
F-277F-502	CH05-11106 GRYM	FA3123	CH-12277 PMTC	FA-836	CH-12268 MOTR	FC106	CH-12385 GPC	FCA-3322	SC14-12254 SOPR
F27820109002	CH-12285 FNDD	FA3127	CH05-11106 PMTC	FA-837	CH06-11056 MOTR	FC109	CH-12248 DTX	FCL-1697	PF-15684 PRFL
F28020009003	ST-13527 FNDD	FA3131	CH06-11295 PMTC	FA-90	CH14-12245 MOTR	FC201	CH06-11295 DTX	FDA-3103	CH-12207 SOPR
F29120009010	CH-12235 FNDD	FA3132	CH-12825 PMTC	FA-931	ST-14343 MOTR	FC202	CH09-12244 DTX	FDA-3105	CH-12214 SOPR
F29120009011	ST-13529 FNDD	FA3141	CH-12491 PMTC	FA-949	PF-15683 MOTR	FC212	CH08-11288 DTX	FDA-3106	CH-13156 SOPR
F34520009001	ST-16488 FNDD	FA3147	CH-13520 PMTC	FA-954	CH05-11106 MOTR	FC214	ST08-11316 DTX	FDA-3110	CH-13150 SOPR
F38520209001	CH-12242 FNDD	FA3150	CH-12485 PMTC	FA-991	CH04-11675 MOTR	FC215	ST06-11315 DTX	FDA-3111	CH-12210 SOPR
F434072	CH10-15371 TJK	FA3151	CH-12209 PMTC	FAC508	CH-11348 FSPA	FC216	SC10-11317 DTX	FDA-3116	CH-12208 SOPR
F-44516-X1	CH-12260 LRN	FA3153	CH-11211 PMTC	FAC677	CH05-12222 FSPA	FC217	CH-12235 DTX	FDA-3117	CH-13157 SOPR
F4BZ7A098A	SC12-11391 FORD	FA3162	CH-12283 PMTC	FAC681	CH06-11056 FSPA	FC217	CH-12235 GPC	FDA-3139	CH-12232 SOPR
FA 3126	CH06-11038 PMTC	FA3192	ST08-11316 PMTC	FAC682	ST08-11316 FSPA	FC218	CH-16873 DTX	FDA-3140	CH-12385 SOPR
FA-1010	ST08-11110 MOTR	FA3193	ST06-11315 PMTC	FAC683	CH08-11288 FSPA	FC220	CH-12231 DTX	FDA-3142	CH-12248 SOPR
FA-1013	ST-13410 MOTR	FA3291	CH-12232 PMTC	FAC800	ST08-12229 FSPA	FC221	CH-12225 DTX	FDA-3143	CH-16873 SOPR
FA-1031	PF-15684 MOTR	FA3301	CH-12980 PMTC	FAC801	CH08-12228 FSPA	FC222	CH12-12251 DTX	FDA-3144	CH-12238 SOPR
FA-124	CH-12262 MOTR	FA3320	CH-12213 PMTC	FAC804	CH06-11295 FSPA	FC252	CH-12242 GPC	FDA-3156	CH-12386 SOPR
FA-130	CH12-12251 MOTR	FA3321	CH-16873 PMTC	FAC805	ST06-11315 FSPA	FC538	CH-13763 GPC	FDA-3260	CH-12242 SOPR
FA-132	CH05-11106 MOTR	FA3322	CH-12250 PMTC	FAC934	CH-12216 FSPA	FC818	CH-16689 GPC	FDA-3261	CH-12231 SOPR
FA-136	CH-12210 MOTR	FA3322	CH-16874 PMTC	FAC935	CH-12215 FSPA	FC832	CH-16928 GPC	FDA-3263	CH-12235 SOPR
FA-137	CH-13150 MOTR	FA3431	CH-12236 PMTC	FAC972	CH-12809 FSPA	FC833	ST10-15380 GPC	FF-821	CH-12208 FLGA
FA1371	CH-12500 PMTC	FA3839	CH-12826 PMTC	FAC974	CH-12386 FSPA	FC843	CH-16294 GPC	FFA-10883	CH-12385 FINN
FA1372	CH-12279 PMTC	FA4000	CH-11789 PMTC	FAC975	CH-12385 FSPA	FC844	SC-16301 GPC	FFA-711	CH-12213 FINN
FA-138	CH-12214 MOTR	FA4101	PF-15690 PMTC	FAC976	CH-12246 FSPA	FCA-1697	PF-15684 PURO	FFA-741	CH-11348 FINN
FA-139	CH-13156 MOTR	FA4102	PF-15693 PMTC	FAC978	CH-12247 FSPA	FCA-3005	CH05-11106 SOPR	FFA-745	CH-12660 FINN
FA1433	CH-13889 PMTC	FA-508	CH-12262 MOTR	FAC980	CH-12235 FSPA	FCA-3007	CH12-12251 SOPR	FFA-746	CH-12826 FINN
FA1456	CH-13190 PMTC	FA-524	CH-12208 MOTR	FAC981	CH-12242 FSPA	FCA-3024	CH12-11389 SOPR	FFA-787	CH-12250 FINN

Number Finder



MFRS. NO.	OUR NO. MFR	MFRS. NO.	OUR NO. MFR	MFRS. NO.	OUR NO. MFR	MFRS. NO.	OUR NO. MFR	MFRS. NO.	OUR NO. MFR
FFA-787	CH-16874 FINN	FHG-08-0195	CH08-11288 DONH	FL-6276	CH-13156 FIAM	FLI-6440	CH06-11056 FIAM	FLI-6622	SC10-11317 FIAM
FFA-788	CH-16873 FINN	FHG-08-0205	CH08-11288 DONH	FL-6277	CH-12214 FIAM	FLI-6441	CH-13141 FIAM	FLI-6623	CH-12282 FIAM
FFA-792A	CH16-12253 FINN	FHG-08-0233	CH08-11288 DONH	FL-6278	CH-12215 FIAM	FLI-6446	CH12-11389 FIAM	FLI-6624	CH-12283 FIAM
FFA-792B	SC-12252 FINN	FHG-08-0270	CH08-11288 DONH	FL-6279	CH-12216 FIAM	FLI-6456	CH08-12228 FIAM	FLI-6627	CH-12285 FIAM
FFA-795	CH12-11389 FINN	FHG-08-0281	CH08-12228 DONH	FL-6304	CH-12091 FIAM	FLI-6457	ST08-12229 FIAM	FLI-6637	CH-12286 FIAM
FFA-799	CH14-12245 FINN	FHG-08-0306	CH08-11288 DONH	FL-6324A	CH-12204 FIAM	FLI-6459	CH-12231 FIAM	FLI-6689	CH-14104 FIAM
FFA-803	CH-12214 FINN	FHG-08-0307	CH08-11288 DONH	FL-6411	CH05-12222 FIAM	FLI-6461	CH-12232 FIAM	FLI-6781	CH-11789 FIAM
FFA-805	CH-12980 FINN	FHG-08-0310	ST08-11316 DONH	FL-6412	CH06-11295 FIAM	FLI-6466	CH-12234 FIAM	FLI-6788	ST-13529 FIAM
FFA-827	CH-12235 FINN	FHG-09-0021	CH09-12244 DONH	FL-6413	ST06-11315 FIAM	FLI-6467	CH-12235 FIAM	FLI-6789	ST-13527 FIAM
FFA-833	CH-12385 FINN	FHG-09-0024	CH09-12244 DONH	FL-6417	CH-12386 FIAM	FLI-6468	CH-12236 FIAM	FLI-6794	CH12-11343 FIAM
FFA-835	CH-12238 FINN	FHG-09-0025	CH09-12244 DONH	FL-6418	ST08-11316 FIAM	FLI-6471	CH-16873 FIAM	FLI-6794	CH-13477 FIAM
FFA-842	CH-12234 FINN	FHG-09-0031	ST09-12265 DONH	FL-6421	CH04-11675 FIAM	FLI-6475	CH-12238 FIAM	FLI-6799	ST-16487 FIAM
FFA-843	CH-12232 FINN	FHG-09-0046	ST09-12265 DONH	FL-6423	CH10-11308 FIAM	FLI-6491	CH-12242 FIAM	FLI-6801	ST-13531 FIAM
FFA-895	CH12-12251 FINN	FHG-09-0053	ST09-12265 DONH	FL-6424	SC10-11317 FIAM	FLI-6495	CH09-12244 FIAM	FLI-6818	CH-12825 FIAM
FFA-897	CH-12660 FINN	FHG-09-0081	CH09-12244 DONH	FL-6438	CH-12225 FIAM	FLI-6496	CH14-12245 FIAM	FLI-6826	CH-15673 FIAM
FFA-898	CH-12283 FINN	FHG-10-0028	CH10-11308 DONH	FL-6439	ST-12226 FIAM	FLI-6500	CH-12246 FIAM	FLI-6838	CH-14107 FIAM
FFA-899	CH-12213 FINN	FHG-10-0035	CH10-11308 DONH	FL-6440	CH06-11056 FIAM	FLI-6501	CH-12247 FIAM	FLI-6860	ST-16880 FIAM
FFA-900	CH-12248 FLGA	FHG-10-0044	CH10-11308 DONH	FL-6441	CH-13141 FIAM	FLI-6503	CH-12248 FIAM	FLI-6862	ST-16879 FIAM
FFA-901	CH-12386 FLGA	FHG-10-0123	CH10-11308 DONH	FL-6446	CH12-11389 FIAM	FLI-6504	CH-12249 FIAM	FM8104273	ST-13530 FNWK
FFA-905	CH-12397 FLGA	FHG-12-0012	CH12-11389 DONH	FL-6457	ST08-12229 FIAM	FLI-6505	CH-12250 FIAM	FM8104273	ST-13530 LINDE
FFA-913	CH-12262 FINN	FHG-12-0037	CH12-11389 DONH	FLA-3007	CH12-12251 SOPR	FLI-6505	CH-16874 FIAM	FMA1532K	CH06-14733 FLTRM
FFA-937	CH-12242 FINN	FHG-12-0062	CH12-11389 DONH	FLI-6181	CH-12207 FIAM	FLI-6507	CH-12980 FIAM	FMA1544S	ST08-11316 FLTRM
FFA-944	CH-13156 FINN	FHG-12-0102	CH12-11389 DONH	FLI-6194	CH-12208 FIAM	FLI-6510	CH12-12251 FIAM	FMA1570	CH21-17070 FLTRM
FFA-952	CH-12264 FINN	FHG-12-0105	CH12-11389 DONH	FLI-6195	CH-13157 FIAM	FLI-6515	SC12-11391 FIAM	FMA1570S	SC21-17075 FLTRM
FFA-953	CH-12246 FINN	FHG-12-0106	CH12-11389 DONH	FLI-6200	CH-12209 FIAM	FLI-6516	SC14-12254 FIAM	FMA2	PF-15677 FLTRM
FFA-955	CH-11211 FINN	FHG-12-0134	CH12-11389 DONH	FLI-6202	CH-12210 FIAM	FLI-6523	SC06-11252 FIAM	FMA216	CH-12207 FLTRM
FHG-05-2558	CH05-11467 DONH	FHG-12-0135	CH12-11389 DONH	FLI-6203	CH-13150 FIAM	FLI-6524	CH-12491 FIAM	FMA224	CH-12208 FLTRM
FHG-05-2559	CH05-11467 DONH	FHG-12-0152	SC10-11317 DONH	FLI-6273	CH-12660 FIAM	FLI-6525	CH-12485 FIAM	FMA226	CH-12214 FLTRM
FHG-05-2560	CH05-11467 DONH	FHG-12-0154	SC12-11391 DONH	FLI-6274	CH-12213 FIAM	FLI-6528	CH-13510 FIAM	FMA229	CH-12209 FLTRM
FHG-05-2561	CH05-11467 DONH	FHG-14-0023	CH14-12245 DONH	FLI-6276	CH-13156 FIAM	FLI-6529	CH-13520 FIAM	FMA244	CH-12260 FLTRM
FHG-05-2562	CH05-11467 DONH	FHG-14-0055	CH14-12245 DONH	FLI-6277	CH-12214 FIAM	FLI-6546	CH08-12228 FIAM	FMA253	CH06-11038 FLTRM
FHG-05-2567	CH05-12222 DONH	FHG-14-0065	CH14-12245 DONH	FLI-6278	CH-12215 FIAM	FLI-6579	CH-11211 FIAM	FMA254K	CH10-12224 FLTRM
FHG-05-2594	CH05-11106 DONH	FHG-14-0103	CH14-12245 DONH	FLI-6279	CH-12216 FIAM	FLI-6580	CH06-12258 FIAM	FMA256K	CH05-11106 FLTRM
FHG-05-2595	CH05-11106 DONH	FHG-14-0118	CH14-12245 DONH	FLI-6304	CH-12091 FIAM	FLI-6582	CH-12260 FIAM	FMA258K	CH08-11003 FLTRM
FHG-05-2599	CH05-11106 DONH	FHG-14-0121	CH14-12245 DONH	FLI-6324A	CH-12204 FIAM	FLI-6584	CH-12262 FIAM	FMA258SY	ST08-11110 FLTRM
FHG-06-5104	CH06-14733 DONH	FHG-14-0152	SC14-12254 DONH	FLI-6406	CH08-12221 FIAM	FLI-6587	CH-12264 FIAM	FMA3659S	CH-12272 FLTRM
FHG-06-5115	CH06-14733 DONH	FHG-14-0164	CH14-12245 DONH	FLI-6411	CH05-12222 FIAM	FLI-6588	ST09-12265 FIAM	FMA4N0015	PF-14090 FLTRM
FHG-06-5124	CH06-11295 DONH	FHG-14-0194	CH14-12245 DONH	FLI-6412	CH06-11295 FIAM	FLI-6589	CH-12266 FIAM	FMA4N0015	PFM-14095 FLTRM
FHG-06-5137	CH06-11295 DONH	FHG-14-0208	CH14-12245 DONH	FLI-6413	ST06-11315 FIAM	FLI-6593	CH-12269 FIAM	FMA4N0326	CH-12271 FLTRM
FHG-06-5140	ST-12226 DONH	FHG-16-0225	CH16-12253 DONH	FLI-6416	CH-12385 FIAM	FLI-6594	SC-12270 FIAM	FMA502	CH16-12253 FLTRM
FHG-06-5152	CH06-11056 DONH	FHG-16-0254	CH16-12253 DONH	FLI-6417	CH-12386 FIAM	FLI-6595	CH-12271 FIAM	FMA502SY	SC-12252 FLTRM
FHG-06-5155	CH06-11295 DONH	FL-6042	CH-12206 FIAM	FLI-6418	ST08-11316 FIAM	FLI-6596	CH-12272 FIAM	FMA507	CH14-12245 FLTRM
FHG-06-5175	CH06-11056 DONH	FL-6044	CH-11348 FIAM	FLI-6421	CH04-11675 FIAM	FLI-6599	CH-12273 FIAM	FMA523	CH12-11389 FLTRM
FHG-06-5181	CH06-11056 DONH	FL-6181	CH-12207 FIAM	FLI-6423	CH10-11308 FIAM	FLI-6600	SC-12274 FIAM	FMA523SY	SC12-11391 FLTRM
FHG-06-5191	CH06-11056 DONH	FL-6194	CH-12208 FIAM	FLI-6424	SC10-11317 FIAM	FLI-6601	CH-12275 FIAM	FMA535	CH-12273 FLTRM
FHG-06-5199	CH06-11056 DONH	FL-6195	CH-13157 FIAM	FLI-6427	CH05-11106 FIAM	FLI-6604	CH-14334 FIAM	FMA535SY	SC-12274 FLTRM
FHG-06-5205	ST06-11315 DONH	FL-6200	CH-12209 FIAM	FLI-6435	CH08-11288 FIAM	FLI-6613	CH-12276 FIAM	FMA536	CH-12266 FLTRM
FHG-06-5207	ST-12226 DONH	FL-6202	CH-12210 FIAM	FLI-6438	CH-12225 FIAM	FLI-6619	CH-12278 FIAM	FMA546	CH10-11308 FLTRM
FHG-06-5211	CH06-11056 DONH	FL-6203	CH-13150 FIAM	FLI-6439	ST-12226 FIAM	FLI-6620	CH08-11935 FIAM	FMA546SY	SC10-11317 FLTRM

Number Finder



MFRS. NO.	OUR NO. MFR	MFRS. NO.	OUR NO. MFR	MFRS. NO.	OUR NO. MFR	MFRS. NO.	OUR NO. MFR	MFRS. NO.	OUR NO. MFR
FMA563	CH-12269 FLTRM	FWA-12-0061	CH12-12251 DONH	FWG-12-0059	CH12-12251 DONH	G12-0022	CH09-12244 GRDIN	GA.1017	CH-12215 GUT
FMA563SY	SC-12270 FLTRM	FWA-12-0063	CH12-12251 DONH	FWG-12-0061	CH12-12251 DONH	G12-0281	CH05-11467 GRDIN	GA.1018	CH-12216 GUT
FPA-3014	CH-11348 SOPR	FWA-12-0075	CH12-12251 DONH	FWG-12-0063	CH12-12251 DONH	G12-0307	ST-13410 GRDIN	GA.1050	CH-12248 GUT
FPA-3254	PF-15684 SOPR	FWA-12-0082	CH12-12251 DONH	FWG-12-0084	CH12-12251 DONH	G12-2492	CH08-12243 GRDIN	GA.1060	CH-12249 GUT
FR-1006	ST-13529 FAML	FWA-12-0084	CH12-12251 DONH	FWG-12-0109	CH12-12251 DONH	G12-2510	CH05-11106 GRDIN	GA.1065	CH-12660 GUT
FR-1018	CH08-11288 FAML	FWA-12-0085	CH12-12251 DONH	FWG-12-0111	CH12-12251 DONH	G12-3160	ST-14343 GRDIN	GA.1066	CH-12386 GUT
FR-1023	CH18-17230 FAML	FWA-12-0091	CH12-12251 DONH	FWG-14-0028	CH14-12245 DONH	G12-4164	CH08-12228 GRDIN	GA.1067	CH-12385 GUT
FR-1024	SC18-17232 FAML	FWA-12-0092	CH12-12251 DONH	FWG-14-0052	CH14-12245 DONH	G12-4526	SC10-11317 GRDIN	GA.1068	CH-12248 GUT
FR-861	CH-12231 FAML	FWA-12-0094	CH12-12251 DONH	FWG-14-0118	CH14-12245 DONH	G12-7532	CH-12276 GRDIN	GA.1070	CH-12235 GUT
FR-865	CH-12235 FAML	FWA-12-0098	CH12-12251 DONH	G01-7064	CH-12262 GRDIN	G12-7787	ST08-12229 GRDIN	GA.1087	CH-16873 GUT
FR-868	ST-13527 FAML	FWD-04-2501	CH04-11675 DONH	G02505-91	CH-12385 PCLN	G12-8407	CH18-17230 GRDIN	GA.1090	CH-12232 GUT
FR-972	CH-12232 FAML	FWG-04-2501	CH04-11675 DONH	G04-2133	PF-15684 GRDIN	G12-8408	SC18-17232 GRDIN	GA.229	CH-12209 GUT
FR-983	CH-16873 FAML	FWG-04-2503	CH04-11675 DONH	G08505-46	ST-16487 PCLN	G-1285M	CH-13157 GNHR	GA.252	CH-12262 GUT
FR-985	ST-16487 FAML	FWG-04-2504	CH04-11675 DONH	G08505-69	SC-12274 PCLN	G13-0502	CH-12286 GRDIN	GA.255	CH12-12251 GUT
FR-986	ST-13530 FAML	FWG-04-2529	CH04-11675 DONH	G10-0890	CH-12262 GRDIN	G13-0761	CH06-11056 GRDIN	GA.256	CH05-11106 GUT
FR-987	ST-13531 FAML	FWG-05-2509	CH05-11106 DONH	G10-1222	CH06-11038 GRDIN	G13-0763	CH-12275 GRDIN	GA.2650	CH-12212 GUT
FS19605	PF-16800 FLEET	FWG-05-2510	CH05-11106 DONH	G10-1237	CH12-12251 GRDIN	G13-0771	CH-14104 GRDIN	GA.3224	CH-12213 GUT
FS19615	PF-15660 FLEET	FWG-05-2511	CH05-11106 DONH	G10-1275	CH05-11106 GRDIN	G13-1333	CH-12273 GRDIN	GA.3271	CH-12250 GUT
FS19733	PF-16805 FLEET	FWG-05-2512	CH05-11106 DONH	G10-2090	CH-12260 GRDIN	G13-1394	ST08-11110 GRDIN	GA.3271	CH-16874 GUT
FS19752	PF-16803 FLEET	FWG-05-2513	CH05-11106 DONH	G10-2745	CH04-11675 GRDIN	G13-6390	CH-12209 GRDIN	GA.507	CH14-12245 GUT
FS19803	PF-16738 FLEET	FWG-05-2516	CH05-11106 DONH	G10-3951	PF-15677 GRDIN	G15-1276	ST-13530 GRDIN	GA.523	CH12-11389 GUT
FWA-05-2526	CH05-11106 DONH	FWG-05-2518	CH05-11106 DONH	G10-6587	CH12-11389 GRDIN	G17-1340	CH-12091 GRDIN	GA.663	CH-11348 GUT
FWA-05-2527	CH05-11106 DONH	FWG-05-2522	CH05-11106 DONH	G10-6632	CH16-12253 GRDIN	G17-2250	CH-12980 GRDIN	GA.666	CH-12206 GUT
FWA-05-2542	CH05-11106 DONH	FWG-05-2523	CH05-11106 DONH	G10-6769	CH14-12245 GRDIN	G17-2253	CH-12386 GRDIN	GA-1008	CH-12207 GNHR
FWA-05-2551	CH05-11106 DONH	FWG-05-2525	CH05-12222 DONH	G10-6775	SC14-12254 GRDIN	G17-2500	CH-12225 GRDIN	GA-1008M	CH-12207 GNHR
FWA-05-2552	CH05-11106 DONH	FWG-05-2527	CH05-11106 DONH	G10-6834	SC12-11391 GRDIN	G23-4401	CH-12242 GRDIN	GA-106	CH14-12245 GNHR
FWA-05-2563	CH05-11106 DONH	FWG-05-2528	CH05-11106 DONH	G10-8668	CH10-11308 GRDIN	G23-4402	CH-12248 GRDIN	GA-106M	CH14-12245 GNHR
FWA-08-0054	CH08-12243 DONH	FWG-05-2530	CH05-11106 DONH	G10-8674	SC10-11317 GRDIN	G23-5000	CH-12234 GRDIN	GA-118	CH05-12222 GNHR
FWA-08-0055	CH08-12243 DONH	FWG-05-2539	CH05-11106 DONH	G10-8736	CH05-12222 GRDIN	G23-5001	CH-12242 GRDIN	GA-118M	CH-12231 GNHR
FWA-08-0517	CH08-12221 DONH	FWG-05-2545	CH05-11106 DONH	G10-9085	SC-12274 GRDIN	G24-6501	CH-12235 GRDIN	GA-1285	CH-13157 GNHR
FWA-08-0518	CH08-12221 DONH	FWG-05-2563	CH04-11675 DONH	G10-9086	CH-12273 GRDIN	G24-7001	CH-12238 GRDIN	GA-1285M	CH-13157 GNHR
FWA-08-0519	CH08-12221 DONH	FWG-05-2575	CH05-11106 DONH	G10-9155	CH-12266 GRDIN	G-2S1285	CH-13157 GRDIN	GA-1286	CH-13156 GNHR
FWA-08-0520	CH08-12221 DONH	FWG-05-2579	CH05-11106 DONH	G10-9200	CH-12269 GRDIN	G-2S1286	CH-13156 GRDIN	GA-1286M	CH-13156 GNHR
FWA-09-3304	CH-12275 DONH	FWG-05-2597	CH05-11106 DONH	G10-9206	SC-12270 GRDIN	G-2S1287	CH-13150 GRDIN	GA-1287	CH-13156 GNHR
FWA-10-0002	CH10-12224 DONH	FWG-05-2619	CH05-11106 DONH	G11-3343	SC10-12395 GRDIN	G43-0510	CH-12209 GRDIN	GA-1287M	CH-13150 GNHR
FWA-10-0012	CH10-12224 DONH	FWG-08-0035	CH08-12221 DONH	G11-4500	ST06-11315 GRDIN	G43-1600	CH-11020 GRDIN	GA-18	CH-12209 GNHR
FWA-10-0051	CH10-12224 DONH	FWG-08-0044	CH08-11288 DONH	G11-4747	CH08-12221 GRDIN	G47-5975	CH-12289 GRDIN	GA-18M	CH-12209 GNHR
FWA-10-0064	CH10-12224 DONH	FWG-08-0228	CH08-12243 DONH	G11-7092	CH-12282 GRDIN	G-4M8047	CH-12208 GRDIN	GA-206	SC14-12254 GNHR
FWA-10-0065	CH10-12224 DONH	FWG-08-0229	CH08-12243 DONH	G11-7781	SC21-17075 GRDIN	G-4M9334	CH-12214 GRDIN	GA-206M	SC14-12254 GNHR
FWA-12-0003	CH12-12251 DONH	FWG-08-0239	CH08-12221 DONH	G11-7782	CH21-17070 GRDIN	G-4M9378	CH-12207 GRDIN	GA-2286	CH-13141 GNHR
FWA-12-0008	CH12-12251 DONH	FWG-08-0276	CH08-11003 DONH	G11-8211	CH14-13356 GRDIN	G-4N0015	PF-14090 GRDIN	GA-24M	CH12-12251 GNHR
FWA-12-0024	CH12-12251 DONH	FWG-09-0071	CH-14104 DONH	G11-8216	SC14-13357 GRDIN	G-4N0015	PFM-14095 GRDIN	GA-262	SC-12274 GNHR
FWA-12-0025	CH12-12251 DONH	FWG-10-0007	SC12-11391 DONH	G11-9135	CH06-11295 GRDIN	G-4N313X	CH-12272 GRDIN	GA-271	PF-15683 GNHR
FWA-12-0035	CH12-12251 DONH	FWG-10-0038	CH10-12224 DONH	G11-9136	CH08-11288 GRDIN	G-4N326X	CH-12271 GRDIN	GA-271M	PF-15683 GNHR
FWA-12-0036	CH12-12251 DONH	FWG-10-0084	CH09-12244 DONH	G11-9363	CH08-11288 GRDIN	G-7M9045	CH-12210 GRDIN	GA-277	PF-15684 GNHR
FWA-12-0044	CH12-12251 DONH	FWG-10-0086	CH10-12224 DONH	G11-9410	ST08-11316 GRDIN	G80-3915	CH14-12245 GRDIN	GA-2798M	CH-12242 GNHR
FWA-12-0051	CH12-12251 DONH	FWG-12-0015	CH12-12251 DONH	G11-9538	CH06-14733 GRDIN	G83-2121	CH-12216 GRDIN	GA-326	CH14-12245 GNHR
FWA-12-0053	CH12-12251 DONH	FWG-12-0024	CH12-12251 DONH	G11-9649	ST-12226 GRDIN	G83-2122	CH-12215 GRDIN	GA-326M	CH14-12245 GNHR
FWA-12-0054	CH12-12251 DONH	FWG-12-0034	CH12-11389 DONH	G11-9778	ST09-12265 GRDIN	G-9S9972	CH-13141 GRDIN	GA-33	CH05-11106 GNHR

Number Finder



MFRS. NO.	OUR NO. MFR	MFRS. NO.	OUR NO. MFR	MFRS. NO.	OUR NO. MFR	MFRS. NO.	OUR NO. MFR	MFRS. NO.	OUR NO. MFR
GA-33M	CH05-11106 GNHR	HCF-11590	CH08-12243 CLARK	HDA5061	CH05-11106 RYCO	HDA5327	CH10-11308 RYCO	HDA5741	CH-12847 RYCO
GA-356	CH-12266 GNHR	HCF-14205	CH08-12243 CLARK	HDA5081	CH-12209 RYCO	HDA5328	SC10-11317 RYCO	HDA5757	CH-12278 RYCO
GA-360	CH12-11389 GNHR	HCF-15919	CH08-12243 CLARK	HDA5109	CH-13157 RYCO	HDA5330	CH05-12222 RYCO	HDA5760	CH-12770 RYCO
GA-360M	CH12-11389 GNHR	HDA-0022	CH09-12244 HDA	HDA5110	CH-13156 RYCO	HDA5334	SC-12274 RYCO	HDA-5961	PF-15677 HDA
GA-361	SC12-11391 GNHR	HDA-0281	CH05-11467 HDA	HDA5111	CH-13150 RYCO	HDA5335	CH-12273 RYCO	HDA-6256	CH10-11308 HDA
GA-405	CH-12235 GNHR	HDA-0307	ST-13410 HDA	HDA5114	CH-12271 RYCO	HDA5336	CH-12266 RYCO	HDA-6257	CH08-11003 HDA
GA-416	CH06-11056 GNHR	HDA-0313	CH-12272 HDA	HDA5119	CH10-11308 RYCO	HDA5338	CH-12269 RYCO	HDA-6259	CH06-11056 HDA
GA-461	CH-12605 GNHR	HDA-0326	CH-12271 HDA	HDA5120	CH10-12224 RYCO	HDA5339	SC-12270 RYCO	HDA-6390	CH-12209 HDA
GA-569	CH21-17070 GNHR	HDA-0502	CH-12286 HDA	HDA5121	CH-12207 RYCO	HDA5357	SC10-12395 RYCO	HDA-6399	CH-12212 HDA
GA-569M	CH21-17070 GNHR	HDA-0591	CH09-12244 HDA	HDA5132	CH12-12251 RYCO	HDA5364	ST06-11315 RYCO	HDA-6587	CH12-11389 HDA
GA-570M	SC21-17075 GNHR	HDA-0760	CH06-11056 HDA	HDA5133	CH-12208 RYCO	HDA5367	CH08-12221 RYCO	HDA-6658	CH21-17070 HDA
GA-8047	CH-12208 GNHR	HDA-0761	CH06-11056 HDA	HDA5157	CH-12214 RYCO	HDA5395	SC21-17075 RYCO	HDA-6659	SC21-17075 HDA
GA-890M	CH-12262 GNHR	HDA-0763	CH-12275 HDA	HDA5159	CH-12210 RYCO	HDA5396	CH21-17070 RYCO	HDA-6660	SC-12252 HDA
GA-892	ST06-11315 GNHR	HDA-0771	CH-14104 HDA	HDA5162	CH-12397 RYCO	HDA5397	CH-12268 RYCO	HDA-6769	CH14-12245 HDA
GA-89M	CH-12262 GNHR	HDA-0776	ST-12226 HDA	HDA5165	CH-12249 RYCO	HDA5402	CH14-13356 RYCO	HDA-6775	SC14-12254 HDA
GA-9045	CH-12210 GNHR	HDA-0890	CH-12262 HDA	HDA5183	CH-12231 RYCO	HDA5403	SC14-13357 RYCO	HDA-6834	SC12-11391 HDA
GA-9045M	CH-12210 GNHR	HDA-0949	ST05-14980 HDA	HDA5184	CH-12209 RYCO	HDA5409	CH06-11295 RYCO	HDA-6840	CH05-11106 HDA
GA-9334	CH-12214 GNHR	HDA-1237	CH12-12251 HDA	HDA5192	CH-12225 RYCO	HDA5414	ST08-11316 RYCO	HDA-6984	ST-12226 HDA
GA-9334M	CH-12214 GNHR	HDA-1240-1	CH04-11675 HDA	HDA5193	CH-12091 RYCO	HDA5415	CH06-14733 RYCO	HDA-6989	CH-12269 HDA
GA-98M	CH08-12221 GNHR	HDA-1275	CH05-11106 HDA	HDA5194	CH-12980 RYCO	HDA5417	CH10-11308 RYCO	HDA-6990	SC-12270 HDA
GAK-1532	CH06-14733 GNHR	HDA-1282	CH09-12244 HDA	HDA5199	CH-12232 RYCO	HDA5418	CH06-11056 RYCO	HDA-7092	CH-12282 HDA
GAK-216	CH06-11056 GNHR	HDA-1285	CH-13157 HDA	HDA5202	CH-12248 RYCO	HDA5419	ST-12226 RYCO	HDA-7443	CH16-12253 HDA
GAK-24	CH12-12251 GNHR	HDA-1286	CH-13156 HDA	HDA5206	CH-16873 RYCO	HDA5420	ST09-12265 RYCO	HDA-7532	CH-12276 HDA
GAK-625	CH09-12244 GNHR	HDA-1287	CH-13150 HDA	HDA5207	CH-12235 RYCO	HDA5422	CH09-12244 RYCO	HDA-7781	SC21-17075 HDA
GAK-98	CH08-12221 GNHR	HDA-1328	CH10-11308 HDA	HDA5210	CH14-12245 RYCO	HDA5426	CH05-11467 RYCO	HDA-7784	CH08-12228 HDA
GAK-98M	CH08-12221 GNHR	HDA-1329	CH10-11308 HDA	HDA5212	CH-11211 RYCO	HDA5427	ST-13410 RYCO	HDA-7797	CH-12268 HDA
GAK-99	CH-12275 GNHR	HDA-1333	CH-12273 HDA	HDA5213	CH-12246 RYCO	HDA5442	CH05-11106 RYCO	HDA-7868	CH08-11288 HDA
GAP-379	PF-15677 GNHR	HDA-1334	SC10-12395 HDA	HDA5214	CH-12264 RYCO	HDA-5444	CH05-11106 HDA	HDA-8047-1	CH-12208 HDA
GAP-379M	PF-15677 GNHR	HDA-1344	ST08-11316 HDA	HDA5216	CH-12247 RYCO	HDA5447	ST-14343 RYCO	HDA-8216	SC14-13357 HDA
GAP-381	PF-14090 GNHR	HDA-1346	CH06-11056 HDA	HDA5226	CH-12212 RYCO	HDA5450	PF-14090 RYCO	HDA-8336	ST06-12048 HDA
GAP-381	PFM-14095 GNHR	HDA-1350	SC10-11317 HDA	HDA5232	CH-12867 RYCO	HDA5450	PFM-14095 RYCO	HDA-8407	CH18-17230 HDA
GDQ621001	CH05-11106 AVBA	HDA-1351-1	SC12-11391 HDA	HDA5246	CH-13141 RYCO	HDA5459	CH08-12228 RYCO	HDA-8408	SC18-17232 HDA
GF-219	SC14-12254 HAST	HDA-1352	SC14-12254 HDA	HDA5265	CH-12215 RYCO	HDA5465	SC10-11317 RYCO	HDA-8668	CH10-11308 HDA
GFE1102	CH-12857 UNIP	HDA-1394	ST08-11110 HDA	HDA5266	CH-12216 RYCO	HDA5488	CH-12276 RYCO	HDA-8674	SC10-11317 HDA
GFE1202	CH12-11389 UNIP	HDA-1399	SC-12252 HDA	HDA5272	CH-12283 RYCO	HDA5490	CH08-12228 RYCO	HDA-8736	CH05-12222 HDA
GFE1204	PF-15680 UNIP	HDA-2090	CH-12260 HDA	HDA5276	CH-12262 RYCO	HDA5493	CH18-17230 RYCO	HDA-8748	CH05-11106 HDA
GFE1206	CH08-11288 UNIP	HDA-2115-1	CH-12275 HDA	HDA5280	CH10-12224 RYCO	HDA5494	SC18-17232 RYCO	HDA-8846	CH-12215 HDA
GFE2102	CH12-11389 UNIP	HDA-2745	CH04-11675 HDA	HDA5281	CH12-12251 RYCO	HDA5504	CH-12286 RYCO	HDA-8852	CH-12216 HDA
GG420-31932	CH04-11675 JDEER	HDA-3149	CH16-12253 HDA	HDA5285	CH08-11003 RYCO	HDA5507	ST08-11110 RYCO	HDA-8999	CH04-11675 HDA
H08505-01	ST09-12265 PCLN	HDA-3152	SC-12252 HDA	HDA5286	CH05-11106 RYCO	HDA5526	ST-13530 RYCO	HDA-9085	SC-12274 HDA
H10105-78	SC10-11317 PCLN	HDA-3160	ST-14343 HDA	HDA5288	CH-12260 RYCO	HDA5527	ST-13531 RYCO	HDA-9135	CH06-11295 HDA
H10505-78	SC10-11317 PCLN	HDA-3179	CH-12273 HDA	HDA5292	CH04-11675 RYCO	HDA5528	ST-13527 RYCO	HDA-9200	CH-12269 HDA
H-425256	CH05-11106 CASE	HDA-3313	CH-12260 HDA	HDA5305	CH08-12221 RYCO	HDA5588	CH-12285 RYCO	HDA-9206	SC-12270 HDA
H51-5200-090-	CH-16928 FNDT	HDA-4500	ST06-11315 HDA	HDA5306	CH-12275 RYCO	HDA5623	CH-12225 RYCO	HDA-9334	CH-12214 HDA
H51-5200-090-	ST10-15380 FNDT	HDA-4526	SC10-11317 HDA	HDA5308	CH08-11288 RYCO	HDA5664	CH06-11295 RYCO	HDA-9340	CH05-11106 HDA
H716.200.090.	CH-16928 FNDT	HDA-4714	PF-15677 HDA	HDA5317	CH12-11389 RYCO	HDA5666	CH06-11038 RYCO	HDA-9363	CH08-11288 HDA
H716.200.090.	ST10-15380 FNDT	HDA-4747	CH08-12221 HDA	HDA5321	CH14-12245 RYCO	HDA-5695	SC-12274 HDA	HDA-9378	CH-12207 HDA
H-99737	CH12-11389 GLN	HDA5050	CH04-11675 RYCO	HDA5322	SC14-12254 RYCO	HDA-5700	CH14-12245 HDA	HDA-9410	ST08-11316 HDA
HCF-11054	CH-12262 CLARK	HDA5055	CH-12272 RYCO	HDA5323	SC12-11391 RYCO	HDA5711	CH-12238 RYCO	HDA-9538	CH06-14733 HDA

Number Finder



MFRS. NO.	OUR NO. MFR	MFRS. NO.	OUR NO. MFR	MFRS. NO.	OUR NO. MFR	MFRS. NO.	OUR NO. MFR	MFRS. NO.	OUR NO. MFR
HDA-9576	CH-12273 HDA	IT117782	CH21-17070 REYTR	KA-14K	CH12-12251 KRK	L2650576	CH10-12390 PPM	LA-134	CH05-11106 KRAL
HDA-9778	ST09-12265 HDA	IT118211	CH14-13356 REYTR	KA-15	CH05-11106 KRK	L2650576	CH10-14455 PPM	LA-134F	CH05-11106 KRAL
HDA-9972	CH-13141 HDA	IT118216	SC14-13357 REYTR	KA-15K	CH05-11106 KRK	L3	CH-12091 DMND	LA-135	CH08-12243 KRAL
HDA-9972-1	CH-13141 HDA	IT120022	CH09-12244 REYTR	KA-18	CH12-1389 KRK	L-30937	CH12-12251 CASE	LA-140	ST08-11110 KRAL
IA-378	CH04-11675 ASHI	IT128407	CH18-17230 REYTR	KA-21	CH-12653 KRK	L-33913	CH10-12224 CASE	LA-142	CH-12209 KRAL
IH20223	CH-13075 SEM	IT128408	SC18-17232 REYTR	KA-22K	CH08-11288 KRK	L-35495	CH14-12245 CASE	LA1434	CH-12225 KRAL
IS124	CH-12980 MAST	IT510	CH-12209 REYTR	KA-23	CH-12213 KRK	L-35496	SC14-12254 CASE	LA1434	CH-12225 M&H
IS126	CH-12232 MAST	IT712	CH-13157 REYTR	KA-26	CH-12250 KRK	L-422	CH12-12251 MOPR	LA1490	CH08-11942 KRAL
IS129	CH-12250 MAST	IT713	CH-13156 REYTR	KA-26	CH-16874 KRK	L-52042	CH08-12243 CASE	LA1491	CH-12485 KRAL
IS129	CH-16874 MAST	IT912	CH-12208 REYTR	KA-29	CH-12660 KRK	L551E/4	CH12-11389 GE	LA1500	CH-12491 KRAL
IS152	CH-16873 MAST	IT9972	CH-13141 REYTR	KA-30	CH14-12245 KRK	L551H/4	CH-12262 GE	LA1526	CH-12716 KRAL
IS153	CH-12209 MAST	JF35/6	CH-12206 LSTRP	KA-71	CH-12209 KRK	L551M/4	CH12-12251 GE	LA1531	CH-12272 KRAL
IS164	CH12-11389 MAST	JF35A/6	CH-12177 LSTRP	KA-83	CH-12262 KRK	L551N/4	CH14-12245 GE	LA1538F	CH06-11880 KRAL
IS166	CH-12235 MAST	JLH0100	CH08-11935 SUMI	KA-87	CH-12264 KRK	L-575	PF-15683 MOPR	LA1553	CH-14722 KRAL
IS177	CH-12385 MAST	JLH100	CH08-11935 L-BL	KA-96	CH-12235 KRK	L-82775	CH08-11288 CASE	LA1584	CH06-11941 KRAL
IS187	CH-12283 MAST	JLH101	ST08-11316 L-BL	KA-97	CH-12248 KRK	L95-407	CH-12653 COPR	LA-161F	CH08-12221 KRAL
IS190	CH-12242 MAST	JLH101	ST08-11316 SUMI	KAP0482	CH-12770 JCB	L95-408	CH12-11389 COPR	LA1623	ST06-12048 KRAL
IS193	CH-12212 MAST	JVA003	CH-12262 EMCO	KAX-00-0171	CH04-11675 DONH	L95-409	CH-12262 COPR	LA1625	ST-14715 KRAL
IS196	CH-12264 MAST	JVA3	CH-12262 EMCO	KAX-00-0372	CH-12262 DONH	L95-412K	CH12-12251 COPR	LA1628	ST05-14980 KRAL
IS207	CH-11211 MAST	JVM10	CH-12262 EMCO	KAX-00-0486	CH-12260 DONH	L95-414K	CH05-11106 COPR	LA1638F	CH08-11003 KRAL
IS210	CH-12236 MAST	JVM3	CH-12262 EMCO	KAX-00-0510	CH05-11106 DONH	L95-417	CH-12826 COPR	LA1765	ST-13529 KRAL
IS214	CH-12386 MAST	JVM5	CH-12262 EMCO	KAX-00-0514	SC12-11391 DONH	L95-419	CH14-12245 COPR	LA-18	PF-14090 KRAL
IS219	CH-12289 MAST	K17505-62	CH-12278 PCLN	KAX-00-2079	CH12-11389 DONH	L95-423	CH-12208 COPR	LA-18	PFM-14095 KRAL
IS244	CH-12206 MAST	K-26046	CH14-12245 BOSS	KAX-00-2371	CH10-12224 DONH	L95-424	CH-12210 COPR	LA-202	PF-15677 KRAL
IS248	CH-12397 MAST	K480 AIR	CH05-11106 DX	KAX-00-2416	CH12-11389 DONH	L95-425	CH-12214 COPR	LA-202B	PF-15677 KRAL
IS74	CH-12213 MAST	K532 AIR	CH-12262 DX	KAX-00-2459	CH12-11389 DONH	L95-426	CH-12207 COPR	LA-208F	CH-12275 KRAL
IS75	CH-12660 MAST	K567 AIR	CH08-11288 DX	KAX-00-2594	CH14-12245 DONH	L95-431	CH-12209 COPR	LA-231F	CH08-11288 KRAL
IS91	CH-12826 MAST	K591 AIR	CH12-12251 DX	KAX-00-2595	CH16-12253 DONH	L95-432	CH-12213 COPR	LA-237	CH-12249 KRAL
IT100853	CH06-14733 REYTR	K592 AIR	CH05-12222 DX	KAX-00-3845	CH14-12245 DONH	L95-434	CH-12250 COPR	LA-249	SC14-12254 KRAL
IT101222	CH06-11038 REYTR	K-6275	CH05-11106 KRNG	KF11	CH-13157 HAST	L95-434	CH-16874 COPR	LA-286	CH14-12245 KRAL
IT101234	CH10-12224 REYTR	K685AIR	CH04-11675 DX	KF12	CH-13156 HAST	L95-445	CH-12660 COPR	LA-288	CH12-12251 WAKO
IT101246	CH08-11003 REYTR	K703 AIR	CH08-12221 DX	KF13	CH-13141 HAST	LA-1001	PF-15683 KRAL	LA-298	CH-12177 KRAL
IT101275	CH05-11106 REYTR	K705 AIR	CH08-11288 DX	KF9	CH-13150 HAST	LA-1003	CH05-11467 KRAL	LA-315	CH-12212 KRAL
IT102090	CH-12260 REYTR	K706 AIR	CH-12275 DX	KRH0786	SC12-11391 L-BL	LA-101F	CH12-12251 KRAL	LA-325	CH14-12245 KRAL
IT106587	CH12-11389 REYTR	K767 AIR	CH10-11308 DX	KSP0027	CH12-11389 SUMI	LA-1048	CH-12283 KRAL	LA-346	CH-11348 KRAL
IT106641	SC-12252 REYTR	K783 AIR	CH09-12244 DX	KSP0028	SC12-11391 SUMI	LA-1049	CH-11211 KRAL	LA-361	CH-12269 KRAL
IT106769	CH14-12245 REYTR	K-922630	CH-12177 CASE	KYX-00-0460	CH-13157 DONH	LA-1050	CH-12264 KRAL	LA-364	CH04-11675 KRAL
IT106775	SC14-12254 REYTR	KA-100	CH-12214 KRK	KYX-00-0461	CH-13156 DONH	LA-1102	ST-13530 KRAL	LA-364F	CH04-11675 KRAL
IT106834	SC12-11391 REYTR	KA-108	CH-12260 KRK	KYX-00-0462	CH-12210 DONH	LA-1103	ST-13531 KRAL	LA-367S	CH10-12224 WAKO
IT108674	SC10-11317 REYTR	KA-11	CH-12262 KRK	KYX-00-2574	CH-12260 DONH	LA-1104	ST-13527 KRAL	LA-368	CH10-11308 WAKO
IT109085	SC-12274 REYTR	KA-111	CH-12242 KRK	KYX-00-3507	SC10-11317 DONH	LA-1106	CH-12289 KRAL	LA-368S	CH10-11308 WAKO
IT109086	CH-12273 REYTR	KA-112	CH-12216 KRK	L03505-30	CH-12385 PCLN	LA-1113F	CH06-11038 KRAL	LA-385	CH12-11389 KRAL
IT109155	CH-12266 REYTR	KA-113	CH-12385 KRK	L08505-50	SC-12270 PCLN	LA-1142	PF-15684 KRAL	LA-390	CH-12403 KRAL
IT109200	CH-12269 REYTR	KA-114	CH-12386 KRK	L-13534	CH12-12251 CASEH	LA-1159	CH-12278 KRAL	LA-395	CH-12847 KRAL
IT109206	SC-12270 REYTR	KA-122	CH-12208 KRK	L-151	PF-14090 MOPR	LA-1166	CH-12278 KRAL	LA-397	CH-12206 KRAL
IT1113	CH-12214 REYTR	KA-125	CH-12397 KRK	L-151	PFM-14095 MOPR	LA-1258F	CH08-12228 KRAL	LA-399F	CH05-12222 KRAL
IT1116	CH-12210 REYTR	KA-126	CH-16873 KRK	L-176	CH05-11106 GRYM	LA-1259	ST08-12229 KRAL	LA-421F	CH10-11308 KRAL
IT114500	ST06-11315 REYTR	KA-136	CH-12213 KRK	L-177	CH05-11106 GRYM	LA1281	CH-12605 KRAL	LA-432	SC12-11391 KRAL
IT117781	SC21-17075 REYTR	KA-14	CH12-12251 KRK	L-22045	CH-12206 GRDN	LA-132	CH-12206 KRAL	LA-434	SC10-11317 KRAL

Number Finder



MFRS. NO.	OUR NO. MFR	MFRS. NO.	OUR NO. MFR	MFRS. NO.	OUR NO. MFR	MFRS. NO.	OUR NO. MFR	MFRS. NO.	OUR NO. MFR
LA-435	SC-12274 KRAL	LA-818	CH-12238 KRAL	LAF-1723	ST06-11315 LBRF	LAF-3710	CH-12867 LBRF	LAF8166	CH-13889 LBRF
LA-437	SC-12270 KRAL	LA-822	CH-12235 KRAL	LAF-1725	ST09-12265 LBRF	LAF-3714	CH-12276 LBRF	LAF-8211	CH14-13356 CHAMP
LA-472	CH-14104 KRAL	LA-84	CH-12210 KRAL	LAF-1726	CH-12278 LBRF	LAF-3715	CH-12264 LBRF	LAF-8211	CH14-13356 LBRF
LA-538	CH-13141 KRAL	LA-85	CH-13150 KRAL	LAF1727	ST-13528 LBRF	LAF-378	CH-12207 LBRF	LAF-8216	SC14-13357 LBRF
LA-549	SC10-12395 KRAL	LA-852	PF-14090 KRAL	LAF-1727	ST-13528 LBRF	LAF-3951	PF-15677 LBRF	LAF-8407	CH18-17230 LBRF
LA-573F	CH08-12221 KRAL	LA-852	PFM-14095 KRAL	LAF1732	CH-12397 LBRF	LAF-398	CH-14104 LBRF	LAF-8408	SC18-17232 LBRF
LA-574	CH21-17070 KRAL	LA-880	CH-12246 KRAL	LAF-1733	CH-12091 LBRF	LAF4127/15-2	CH05-12222 CHMPI	LAF8503	CH-12980 LBRF
LA-60	CH-12262 KRAL	LA-884	CH18-17230 KRAL	LAF1734	CH06-11056 LBRF	LAF4139/15-2	CH08-12228 CHMPI	LAF-8513	SC-12270 LBRF
LA-601F	CH06-14733 KRAL	LA-885	SC18-17232 KRAL	LAF1735	ST-12226 LBRF	LAF4177/15-2	CH06-12258 CHMPI	LAF-8515	CH06-11941 LBRF
LA-608	CH-12273 KRAL	LA-890	CH08-12228 KRAL	LAF-1737	CH-12781 LBRF	LAF4322/15-2	CH-12232 CHMPI	LAF-8517	CH06-12258 LBRF
LA-617	SC21-17075 KRAL	LA-890F	CH08-12228 KRAL	LAF1739	CH-13050 LBRF	LAF4345/15-2	CH-12215 CHMPI	LAF-8525	ST06-11109 LBRF
LA-618	CH-12268 KRAL	LA-891	ST08-12229 KRAL	LAF-1741	CH-12285 LBRF	LAF-45	CH-12210 CHAMP	LAF-8526	ST06-11109 LBRF
LA-632	CH06-11056 KRAL	LA-905	CH-12286 KRAL	LAF-1743	CH-11211 LBRF	LAF-45	CH-12210 LBRF	LAF-8529	CH-12857 LBRF
LA-632F	CH06-11056 KRAL	LA-906	CH-12276 KRAL	LAF-1747	CH-12283 LBRF	LAF4514	CH-12775 CHMPI	LAF-8549	CH-12272 LBRF
LA-633	ST-12226 KRAL	LA-907	SC10-11317 KRAL	LAF1750	CH-12387 LBRF	LAF4514	CH-12775 LBRF	LAF-8550	CH-12271 LBRF
LA-641	CH14-13356 KRAL	LA-913	CH-12231 KRAL	LAF1763	CH-12246 LBRF	LAF4544	CH08-17365 LBRF	LAF-8557	CH-12283 LBRF
LA-642	SC14-13357 KRAL	LA-915	PF-15684 KRAL	LAF1764	CH-12247 LBRF	LAF4545	ST08-14413 LBRF	LAF8560	ST10-11239 LBRF
LA-643	CH-12250 KRAL	LA-946	CH-12215 KRAL	LAF-1766	CH-12206 LBRF	LAF-46	CH-13150 CHAMP	LAF8561	CH10-11117 LBRF
LA-643	CH-16874 KRAL	LA-948	CH-12216 KRAL	LAF1777	SC14-13357 LBRF	LAF-46	CH-13150 LBRF	LAF8562	ST05-11108 LBRF
LA-644	CH05-11467 KRAL	LA-977	CH-12397 KRAL	LAF-1793	ST-14343 LBRF	LAF-47	CH-12208 CHAMP	LAF8564	CH-12660 LBRF
LA-644F	CH05-11467 KRAL	LA-98	CH-12262 KRAL	LAF-1798	CH-12234 LBRF	LAF-47	CH-12208 LBRF	LAF-8567	CH-12225 LBRF
LA-649	CH-12209 KRAL	LA-981	CH-12225 KRAL	LAF-1826	CH-12403 LBRF	LAF-4714	PF-15677 CHAMP	LAF-8568	ST-16876 LBRF
LA-658	CH08-11288 KRAL	LA-982	CH-12091 KRAL	LAF-1842	CH08-12221 LBRF	LAF-4714	PF-15677 LBRF	LAF8569	CH-12302 LBRF
LA-658F	CH08-11288 KRAL	LA-985	CH-12236 KRAL	LAF1948	ST-13410 LBRF	LAF-4747	CH08-12221 LBRF	LAF8570	CH-12213 LBRF
LA-672	CH-12282 KRAL	LA-986	CH-16873 KRAL	LAF-2052	CH-12385 LBRF	LAF-4759	CH-12289 LBRF	LAF8571	CH-12826 LBRF
LA-675	ST08-11316 KRAL	LA-992	ST-14343 KRAL	LAF-237	CH12-12251 CHAMP	LAF-48	CH-13157 CHAMP	LAF-8571	CH-12213 LBRF
LA-690F	CH08-11288 KRAL	LAF-1246B	CH08-12243 LBRF	LAF-237	CH12-12251 LBRF	LAF-48	CH-13157 LBRF	LAF8576	CH-12809 LBRF
LA-691	ST06-11315 KRAL	LAF-1275	CH05-11106 CHAMP	LAF-237A	CH12-12251 LBRF	LAF-5043	CH08-12221 LBRF	LAF8579	CH-12653 LBRF
LA-692	CH06-11295 KRAL	LAF-1275	CH05-11106 LBRF	LAF-2608	CH-11020 LBRF	LAF-5054	CH-12275 LBRF	LAF8580	CH-12236 LBRF
LA-75	CH-12260 KRAL	LAF-1275B	CH05-11106 LBRF	LAF-265	CH-12262 CHAMP	LAF-5054A	CH-12275 CHAMP	LAF8581	CH-12215 LBRF
LA-755	ST09-12265 KRAL	LAF-131	CH-12209 CHAMP	LAF-265	CH-12262 LBRF	LAF-5054A	CH-12275 LBRF	LAF8582	CH-12216 LBRF
LA-76	CH-12208 KRAL	LAF-131	CH-12209 LBRF	LAF-265HD	CH-12262 CHAMP	LAF-5054B	CH-12275 LBRF	LAF8583	CH08-11935 LBRF
LA-77	CH-13157 KRAL	LAF-1394	ST08-11110 LBRF	LAF-265HD	CH-12262 LBRF	LAF-5368	CH08-11288 CHAMP	LAF8584	CH-13185 LBRF
LA-770	CH-12272 KRAL	LAF1466	CH06-11941 LBRF	LAF2736	CH-13157 LBRF	LAF-5368	CH08-11288 LBRF	LAF8589	ST-14787 LBRF
LA-773	CH-12271 KRAL	LAF-15	PF-14090 LBRF	LAF-2745	CH04-11675 LBRF	LAF5859	CH-12752 LBRF	LAF8598	ST-14183 LBRF
LA-773	CH-12215 WAKO	LAF-15	PFM-14095 LBRF	LAF-2745A	CH04-11675 CHAMP	LAF-6587	CH12-11389 CHAMP	LAF8601	CH-12238 LBRF
LA-776F	CH10-11308 KRAL	LAF-1544	CH08-11288 LBRF	LAF-2745A	CH04-11675 LBRF	LAF-6587	CH12-11389 LBRF	LAF8602	CH-13811 LBRF
LA-777F	CH09-12244 KRAL	LAF-1711	ST-16488 LBRF	LAF-281	CH05-11467 CHAMP	LAF-6769	CH14-12245 CHAMP	LAF8603	CH-13270 LBRF
LA-78	CH-12214 KRAL	LAF-1712	CH-12231 LBRF	LAF-281	CH05-11467 LBRF	LAF-6769	CH14-12245 LBRF	LAF8604	CH-12250 LBRF
LA-781F	CH08-12243 KRAL	LAF-1713	ST-16487 LBRF	LAF-290A	CH-12260 CHAMP	LAF-6775	SC14-12254 LBRF	LAF8604	CH-16874 LBRF
LA-782F	CH05-11106 KRAL	LAF-1714	CH-12386 LBRF	LAF-290A	CH-12260 LBRF	LAF-6834	SC12-11391 CHAMP	LAF8605	ST-14183 LBRF
LA-79	CH-13156 KRAL	LAF-1715	ST-13530 LBRF	LAF-334	CH-12214 CHAMP	LAF-6834	SC12-11391 LBRF	LAF8606	CH-12485 LBRF
LA-791	CH-12385 KRAL	LAF-1716	CH-12242 LBRF	LAF-334	CH-12214 LBRF	LAF-7092	CH-12282 CHAMP	LAF8607	CH-12491 LBRF
LA-80	CH-12207 KRAL	LAF-1717	ST-13527 LBRF	LAF-335	CH-13156 CHAMP	LAF-7092	CH-12282 LBRF	LAF8608	CH-12498 LBRF
LA-812	CH-12980 KRAL	LAF-1718	CH-12235 LBRF	LAF-335	CH-13156 LBRF	LAF-7672	CH14-12245 LBRF	LAF8609	CH-11789 LBRF
LA-813	CH-12386 KRAL	LAF-1719	ST-13529 LBRF	LAF336	CH-13141 LBRF	LAF-7781	SC21-17075 LBRF	LAF8610	CH08-11942 LBRF
LA-814	CH-12232 KRAL	LAF-1720	ST-13531 LBRF	LAF-3702	CH-16873 LBRF	LAF-7782	CH21-17070 LBRF	LAF8611	CH-12500 LBRF
LA-816	CH-12242 KRAL	LAF-1721	ST08-11316 LBRF	LAF-3703	CH-12232 LBRF	LAF-7797	CH-12268 CHAMP	LAF8612	CH-12279 LBRF
LA-817	CH-12248 KRAL	LAF1722	CH06-11295 LBRF	LAF-3704	CH-12248 LBRF	LAF-7797	CH-12268 LBRF	LAF8613	CH-12302 LBRF

Number Finder



MFRS. NO.	OUR NO. MFR	MFRS. NO.	OUR NO. MFR	MFRS. NO.	OUR NO. MFR	MFRS. NO.	OUR NO. MFR	MFRS. NO.	OUR NO. MFR
LAF8617	CH-12286 LBRF	LAF9972	CH-13141 LBRF	LK-3521	SC21-17075 APLKH	LL1884	CH12-11389 BALD	LX273	CH-12278 MAHLE
LAF8618	ST08-12229 LBRF	LH42924001	CH06-11038 HTCH	LK-3522	CH10-11308 APLKH	LL1885	CH14-12245 BALD	LX274	CH-12238 MAHLE
LAF8619	CH08-12228 LBRF	LH8617	CH-12286 LBRF	LK-3523	SC10-11317 APLKH	LL1886	CH-12273 BALD	LX275	CH-12231 MAHLE
LAF8623	ST-16879 LBRF	LI-2616	CH-11348 FSPA	LK-3524	CH09-12244 APLKH	LL1894	CH-12266 BALD	LX28	CH12-11389 MAHLE
LAF8625	CH-12177 LBRF	LI-2695	CH-11348 FSPA	LK-3527	ST09-12265 APLKH	LL1895	CH-12269 BALD	LX28	CH-12246 MAHLE
LAF8628	PF-15686 LBRF	LI-2695	CH-11348 PURO	LK-3528	CH-13050 APLKH	LL1902-FN	CH10-11308 BALD	LX29	CH14-12245 MAHLE
LAF8635	CH-13824 LBRF	LI-3868	CH-12249 PURO	LK-3529	SC10-11317 APLKH	LL1926	CH-12271 BALD	LX31	CH-12268 MAHLE
LAF8649	CH-15300 LBRF	LI-4112	CH-12216 PURO	LK-3530	CH06-11056 APLKH	LL2344-FN	CH05-11467 BALD	LX32	CH06-11295 MAHLE
LAF8651	CH-12825 LBRF	LI-4113	CH-12215 PURO	LK-3531	ST-12226 APLKH	LL2360-FN	CH06-14733 BALD	LX33	CH09-12244 MAHLE
LAF8658	CH-14107 LBRF	LK-191	CH-12839 APLKH	LK-3532	CH08-12228 APLKH	LL2426FN	CH09-12244 BALD	LX334	PF-15690 MAHLE
LAF8659	CH05-12222 LBRF	LK-192	CH-12177 APLKH	LK-3533	ST08-12229 APLKH	LL2453	CH21-17070 BALD	LX335	PF-15693 KNCT
LAF-8662	CH10-11308 LBRF	LK-3008	CH-13157 APLKH	LK-3550	CH06-12258 APLKH	LL2562	CH18-17230 BALD	LX345	CH-14107 KNCT
LAF8664	CH-12798 LBRF	LK-3027	SC14-12254 APLKH	LK-3635	CH-12781 APLKH	LL2608	CH-11020 BALD	LX437	CH-12870 KNCT
LAF8665	SC06-11252 LBRF	LK-3028	CH-12266 APLKH	LK-3658	ST-16487 APLKH	LL2641	CH-12276 BALD	LX47	CH-12213 MAHLE
LAF-8668	CH10-11308 CHAMP	LK-3029	CH05-12222 APLKH	LK-3659	ST-13530 APLKH	LL2783	CH-12286 BALD	LX496	CH-11789 KNCT
LAF-8668	CH10-11308 LBRF	LK-3032	CH05-12222 APLKH	LK-3660	ST-13531 APLKH	LL-5448	CH-12260 P-M	LX530	CH-12250 KNCT
LAF-8674	SC10-11317 CHAMP	LK-3036	CH-12208 APLKH	LK-3661	ST-13527 APLKH	LL-847-144	CH14-12245 P-M	LX530	CH-16874 KNCT
LAF-8674	SC10-11317 LBRF	LK-3152	CH-12249 APLKH	LK-3662	ST-13529 APLKH	LL-847-43	CH12-12251 P-M	LX531	CH-12387 KNCT
LAF-8736	CH05-12222 LBRF	LK-3164	CH-12215 APLKH	LK-3682	CH-12283 APLKH	LO-176	CH05-11106 CNTL	LX584	CH-14104 KNCT
LAF8804	CH06-11880 LBRF	LK-3165	CH-12216 APLKH	LK-3719	CH-13050 APLKH	LO-176	CH05-11106 WISC	LX612	CH-14900 KNCT
LAF8809	CH-13090 LBRF	LK-3290	CH-12953 APLKH	LK-3740	CH-12857 APLKH	LO-177	CH05-11106 GRYM	LX631	CH-15304 KNCT
LAF8811	CH-13520 LBRF	LK-3309	ST08-11316 APLKH	LK-3748	CH-12867 APLKH	LX102	CH-12264 MAHLE	LX83	CH-12809 MAHLE
LAF8814	CH-12239 LBRF	LK-3323	CH-12242 APLKH	LK-500	CH-12177 APLKH	LX116	CH-12208 MAHLE	LX84	CH-11211 MAHLE
LAF8817	CH-13510 LBRF	LK-3331	CH-12386 APLKH	LK-651	CH-12209 APLKH	LX13	CH04-11675 MAHLE	LX-84	CH-11211 PURO
LAF8818	CH-12770 LBRF	LK-3335	CH-12660 APLKH	LK-700	CH12-11389 APLKH	LX14	CH05-11106 MAHLE	LX93	CH-12283 MAHLE
LAF8819	CH-12605 LBRF	LK-3336	CH-12232 APLKH	LK-712	CH-12213 APLKH	LX15	CH-12209 MAHLE	LX99	CH-12285 MAHLE
LAF8820	CH-12953 LBRF	LK-3342	PF-15684 APLKH	LK-713	CH-12653 APLKH	LX155	CH-12249 MAHLE	LXS19	CH-13157 MAHLE
LAF8821	CH-12604 LBRF	LK-3345	CH-12246 APLKH	LK-795	CH14-12245 APLKH	LX174	CH-12177 MAHLE	LXS201	SC12-11391 MAHLE
LAF8822	CH10-12390 LBRF	LK-3347	CH-12385 APLKH	LK-839	CH-12235 APLKH	LX179	CH-11789 MAHLE	LXS212	ST06-11315 MAHLE
LAF8822	CH10-14455 LBRF	LK-3350	CH-12247 APLKH	LK-846	CH-12250 APLKH	LX18	CH08-11288 MAHLE	LXS214	ST08-11316 MAHLE
LAF8823	CH-12716 LBRF	LK-3351	CH-12236 APLKH	LK-846	CH-16874 APLKH	LX192	CH-12953 MAHLE	LXS25	SC14-12254 MAHLE
LAF8974E	CH-13075 LBRF	LK-3422	CH05-11106 APLKH	LK-848	CH-12262 APLKH	LX196	CH-12091 MAHLE	LXS30	SC10-11317 MAHLE
LAF8976E	CH-12790 LBRF	LK-3446	CH-12231 APLKH	LK-850	CH12-12251 APLKH	LX21	CH12-12251 MAHLE	LXS34	ST09-12265 MAHLE
LAF8977E	CH-12794 LBRF	LK-3451	CH-11211 APLKH	LK-852	CH-12260 APLKH	LX22	CH-12212 MAHLE	LXS37	ST-13531 MAHLE
LAF8979E	CH12-11343 LBRF	LK-3452	CH-12264 APLKH	LK-855	CH-12248 APLKH	LX227	CH-12242 MAHLE	LXS371	ST-13531 KNCT
LAF8979E	CH-13477 LBRF	LK-3454	CH-12213 APLKH	LK-860	CH08-11288 APLKH	LX231	CH-12248 MAHLE	LXS40	ST-16488 MAHLE
LAF8980E	CH-13190 LBRF	LK-3457	CH-12289 APLKH	LK-920	PF-15680 APLKH	LX236	CH-12386 MAHLE	LXS401	ST-16488 KNCT
LAF8991	CH-13763 LBRF	LK-3486	CH-12752 APLKH	LK-925	CH05-12222 APLKH	LX240	CH-12234 MAHLE	LXS41	ST-13530 MAHLE
LAF-9001	CH09-12244 LBRF	LK-3497	CH04-11675 APLKH	LKS37	ST-13531 KNCT	LX241	CH-16873 MAHLE	LXS411	ST-13530 KNCT
LAF-9085	SC-12274 CHAMP	LK-3502	CH-12275 APLKH	LL1615	CH-12208 BALD	LX242	CH-12980 MAHLE	LXS42	ST-13527 MAHLE
LAF-9085	SC-12274 LBRF	LK-3504	SC12-11391 APLKH	LL1634	CH-12214 BALD	LX243	CH-12232 MAHLE	LXS421	ST-13527 KNCT
LAF-9086	CH-12273 LBRF	LK-3507	SC14-12254 APLKH	LL1636-FN	CH10-12224 BALD	LX259	PF-15684 KNCT	LXS43	ST-13529 MAHLE
LAF-9155	CH-12266 CHAMP	LK-3510	CH06-11295 APLKH	LL1646-FN	CH12-12251 BALD	LX263	CH-12246 MAHLE	LXS431	ST-13529 KNCT
LAF-9200	CH-12269 CHAMP	LK-3511	ST06-11315 APLKH	LL1649	CH-12260 BALD	LX265	CH-12385 MAHLE	LXS44	ST-13528 MAHLE
LAF-9200	CH-12269 LBRF	LK-3516	CH-12269 APLKH	LL1667-FN	CH06-11038 BALD	LX268	CH-12247 MAHLE	LXS51	ST-16487 KNCT
LAF-9373	SC14-12254 LBRF	LK-3517	SC-12270 APLKH	LL1669	CH-12210 BALD	LX269	CH-12236 MAHLE	LXS61	ST-16880 KNCT
LAF-9410	ST08-11316 LBRF	LK-3518	CH-12273 APLKH	LL1681-FN	CH08-11003 BALD	LX27	CH10-11308 MAHLE	LXS62	ST-16876 MAHLE
LAF-9538	CH06-14733 LBRF	LK-3519	SC-12274 APLKH	LL1690-FN	CH05-11106 BALD	LX271	CH-12235 MAHLE	M08505-29	SC-12252 PCLN
LAF-9778	ST09-12265 LBRF	LK-3520	CH21-17070 APLKH	LL1846	CH16-12253 BALD	LX272	CH-12397 MAHLE	M08505-51	CH-12269 PCLN

Number Finder



MFRS. NO.	OUR NO. MFR	MFRS. NO.	OUR NO. MFR	MFRS. NO.	OUR NO. MFR	MFRS. NO.	OUR NO. MFR	MFRS. NO.	OUR NO. MFR
M12000149	CH-12273 VME	MD152K	CH05-11106 ALCO	MF-706A	CH-12660 PURO	P-055591	CH12-11389 LRN	P11-0558	CH14-12245 DON
M12000149	CH-12273 VCE	MD160	CH-12660 ALCO	MF-712A	CH-12213 PURO	P10.11420.111	PF-15703 PRIN	P11-0559	SC14-12254 DON
M21505-34	CH-12798 PCLN	MD200	CH-12250 ALCO	MF-713A	CH-12653 PURO	P10.15401.11C	CH05-11106 PRIN	P11-1065	CH-12284 DON
M-27265-1	CH05-11106 AMHO	MD200	CH-16874 ALCO	MF-839A	CH-12235 PURO	P10.15606.11C	CH06-11038 PRIN	P11-1098	PF-15677 DON
MA-289	CH-12206 GRDN	MD202	CH-12653 ALCO	MF-860K	CH08-11288 PURO	P10.15741.11C	CH-12716 PRIN	P11-1776	SC-12274 DON
MA3660	PF-15684 MOTRI	MD220K	CH12-12251 ALCO	MFP-191A	CH-12839 PURO	P10-0590	CH-12262 DON	P11-2031	CH12-12251 DON
MA384	CH12-11389 CLEAN	MD222	CH14-12245 ALCO	MFP-192A	CH-12177 PURO	P10-0890	CH-12262 DON	P11-2830	CH-12262 DON
MA-4481	CH-14211 AMC	MD224	CH12-11389 ALCO	MFP-764A	CH-12249 PURO	P101	PF-15677 HRMO	P11-3179	CH-12273 DON
MA-463	CH10-12224 ASHI	MD230	CH-12385 ALCO	MG-221406	CH05-11467 JDEER	P10-1203	CH-12262 DON	P11-3341	CH10-11308 DON
MA-464	CH10-11308 ASHI	MD234	CH-12238 ALCO	MG-272744	ST-13410 JDEER	P10-1237	CH12-12251 DON	P11-3343	SC10-12395 DON
MA521	CH-12282 CLEAN	MD238	CH-12235 ALCO	MG621100301	CH-12269 AVBA	P10-1275	CH05-11106 DON	P11-3501	CH-14104 DON
MA567	CH-12278 CLEAN	MD260K	CH08-11288 ALCO	MG621100302	SC-12270 AVBA	P10-2090	CH-12260 DON	P11-4500	ST06-11315 DON
MA-583	CH-12215 ASHI	MD-26814	CH-12266 MRPY	MHC203252	CH-12385 CASEI	P10-2237	CH-12260 DON	P11-4506	ST06-11315 DON
MA6611P	CH-12385 M	MD292	CH-12262 ALCO	MM510109	CH04-11675 MTSB	P102525	CH12-12251 DON	P11-4747	CH08-12221 DON
MA6618	CH-16873 M	MD300	CH-12386 ALCO	MT621024302	SC10-11317 AVBA	P10-2745	CH04-11675 DON	P11-4748	CH-12275 DON
MA6620	CH-12660 M	MD320K	CH08-12221 ALCO	MZ311786	CH-14211 MTSB	P102913	ST08-11316 PRKN	P11-5623	CH12-11389 DON
MA6621P	CH-12250 M	MD352	CH-12210 ALCO	N01371	CH12-12251 BAUR	P10-3688	PF-15677 DON	P11-6501	CH12-11389 DON
MA6621P	CH-16874 M	MD360	CH-12214 ALCO	N02206	CH05-11106 BAUR	P10-3951	PF-15677 DON	P11-6502	SC12-11391 DON
MA6622P	CH-12980 M	MD382	CH-12242 ALCO	N07698	CH08-11288 BAUR	P10-4384	CH-13157 DON	P11-6541	SC12-11391 DON
MA6623P	CH-12232 M	MD388	CH-11211 ALCO	N08109	CH09-12244 BAUR	P10-4385	CH-13156 DON	P11-6570	CH-13141 DON
MA6628	CH-12283 M	MD-38-82	CH12-11389 MRPY	N08152	CH06-11295 BAUR	P10-4387	CH-13150 DON	P11-7053	CH-12260 DON
MA6632P	CH-12209 M	MD-38-83	SC12-11391 MRPY	N08176	CH12-11389 BAUR	P10-5043	CH08-12221 DON	P11-7089	CH-12282 DON
MA6637P	CH-12242 M	MD392	CH-12225 ALCO	N08177	SC12-11391 BAUR	P-1050506	SC21-17075 CASE	P11-7092	CH-12282 DON
MA6643	CH-12264 M	MD410	PF-15680 ALCO	N08463	CH14-12245 BAUR	P-1050507	CH21-17070 CASE	P11-7433	CH-12269 DON
MA6655	CH-12653 M	MD436	PF-15684 ALCO	N08464	SC14-12254 BAUR	P10-5054	CH-12275 DON	P11-7435	CH-12273 DON
MA6659	CH-12246 M	MD478	CH-12264 ALCO	N08466	ST09-12265 BAUR	P10-5368	CH08-11288 DON	P11-7437	CH14-12245 DON
MA6679	CH-12386 M	MD480	CH-12246 ALCO	N08505-29	SC-12252 PCLN	P10-5555	CH04-11675 DON	P11-7439	CH12-11389 DON
MA6680	CH-12206 M	MD484	CH-16873 ALCO	N08567	CH10-11308 BAUR	P10-5629	CH05-11106 DON	P11-7441	CH-12266 DON
MA6681	CH-12249 M	MD486	CH-12246 ALCO	N08568	SC10-11317 BAUR	P10-5961	PF-15677 DON	P11-7443	CH16-12253 DON
MA6682	CH-12213 M	MD488	CH-12980 ALCO	N10119	ST08-11316 BAUR	P10-6273	CH-12262 DON	P11-7580	CH-12273 DON
MA6683	CH-12289 M	MD492	CH-12091 ALCO	N-6656	CH-12269 CASE	P10-6278	CH-12260 DON	P11-7781	SC21-17075 DON
MA6684	CH-11211 M	MD494	CH-12285 ALCO	N-6660	SC12-11391 CASE	P10-6587	CH12-11389 DON	P11-7782	CH21-17070 DON
MA6702	CH-12397 M	MD498	CH-12231 ALCO	N-6778	CH06-14733 CASE	P10-6769	CH14-12245 DON	P11-7939	CH12-11389 DON
MA6708	CH-12177 M	MD512	CH-12273 ALCO	N-7028	CH09-12244 CASE	P10-6775	SC14-12254 DON	P11-8159	CH10-12224 DON
MA6709	CH12-11389 M	MD514	SC-12274 ALCO	N-8153	ST08-11316 CASE	P10-6834	SC12-11391 DON	P11-8160	CH08-11003 DON
MA6713	CH-12839 M	MD520	CH-12248 ALCO	NCM101	CH05-11106 COFAM	P10-7672	CH14-12245 DON	P11-8166	CH10-11308 DON
MA6720	CH-12236 M	MD522K	CH05-12222 ALCO	NCM109	CH-12272 COFAM	P10-7868	CH08-11288 DON	P11-8211	CH14-13356 DON
MA673P	CH-12213 M	MD524	CH-12213 ALCO	ND-104344-A	CH-12262 DMNDT	P10-8668	CH10-11308 DON	P11-8216	SC14-13357 DON
MA674P	CH-12660 M	MD-620563	CH-14211 MTSB	NE6003	CH14-12245 NEM	P10-8674	SC10-11317 DON	P11-8678	CH-12275 DON
MA684	CH-12235 M	MDA-38-23	CH12-12251 MRPY	NE625S	CH10-11308 NEM	P10-8736	CH05-12222 DON	P11-9100	CH09-12244 DON
MA744	CH-12809 CLEAN	ME-033617	CH10-12224 MTSB	OE30128	CH-12262 RR	P10-9085	SC-12274 DON	P-11913	CH12-12251 LRN
MAK271	PF-15683 MOTRI	ME-060219	CH10-12224 MTSB	OE45176	CH10-11308 RR	P10-9200	CH-12269 DON	P11-9135	CH06-11295 DON
MAK6693	CH05-11106 M	ME-063874	CH14-12245 MTSB	OPA3192	PF-15683 XSV	P10-9206	SC-12270 DON	P11-9136	CH08-11288 DON
MAT 6702	CH-12397 M	ME-063879	CH10-11308 MTSB	OPA3465	PF-15684 XSV	P11-0544	CH04-11675 DON	P11-9235	CH-12273 DON
MAT-6684	CH-11211 M	MF-190	CH-12206 PURO	P01-7064	CH-12262 DON	P11-0545	CH05-11106 DON	P11-9237	CH16-12253 DON
MD022	CH-12177 ALCO	MF-192A	CH-12177 PURO	P01-8706	CH-12210 DON	P11-0554	CH10-11308 DON	P11-9238	CH-12260 DON
MD062	CH-12206 ALCO	MF-500A	CH-12177 PURO	P01-8709	CH-12208 DON	P11-0555	SC10-11317 DON	P11-9247	CH10-12224 DON
MD116	CH-12209 ALCO	MF-651A	CH-12209 PURO	P01-9159	CH-12214 DON	P11-0556	CH12-11389 DON	P11-9340	CH05-11106 DON
MD124	CH-12212 ALCO	MF-700A	CH12-11389 PURO	P01-9167	CH-12207 DON	P11-0557	SC12-11391 DON	P11-9363	CH08-11288 DON

Number Finder



MFRS. NO.	OUR NO. MFR	MFRS. NO.	OUR NO. MFR	MFRS. NO.	OUR NO. MFR	MFRS. NO.	OUR NO. MFR	MFRS. NO.	OUR NO. MFR
P11-9370	SC-12274 DON	P12-2510	CH05-11106 DON	P13-1328	CH10-11308 DON	P13-6991	SC18-17232 DON	P14-5444	CH05-11106 DON
P11-9371	SC-12270 DON	P12-2694	CH-12262 DON	P13-1329	CH10-11308 DON	P13-7178	CH-12268 DON	P14-5520	CH-12269 DON
P11-9372	SC-12252 DON	P12-2696	CH12-12251 DON	P13-1333	CH-12273 DON	P13-8133	CH-12273 DON	P14-5521	CH-12273 DON
P11-9373	SC14-12254 DON	P12-2836	CH16-12253 DON	P13-1334	SC10-12395 DON	P13-8336	ST06-12048 DON	P14-5655	CH04-11675 DON
P11-9374	SC12-11391 DON	P12-2837	SC-12252 DON	P13-1344	ST08-11316 DON	P13-8338	CH-12247 DON	P14-5695	SC-12274 DON
P11-9375	SC10-11317 DON	P12-2860	CH06-11056 DON	P13-1346	CH06-11056 DON	P13-8428	CH-13050 DON	P14-5700	CH-12798 DON
P11-9409	CH08-11288 DON	P12-2991	ST08-11316 DON	P13-1350	SC10-11317 DON	P13-8748	CH05-11106 DON	P14-5895	CH09-12244 DON
P11-9410	ST08-11316 DON	P12-3160	ST-14343 DON	P13-1351	SC12-11391 DON	P13-8751	CH-12208 DON	P14-8380	CH12-11389 DON
P11-9538	CH06-14733 DON	P12-3405	CH08-11288 DON	P13-1352	SC14-12254 DON	P13-8752	CH-12214 DON	P14-8381	CH10-11308 DON
P11-9576	CH-12273 DON	P12-3412	PF-14090 DON	P13-1394	ST08-11110 DON	P13-8753	CH-12210 DON	P14-8383	CH05-11106 DON
P11-9612	CH10-11308 DON	P12-3412	PFM-14095 DON	P13-1399	SC-12252 DON	P13-8845	CH-12207 DON	P14-8384	ST09-12265 DON
P11-9613	SC10-12395 DON	P12-3753	CH08-11288 DON	P13-1403	CH08-11288 DON	P13-8861	CH-12403 DON	P14-8821	CH12-11389 DON
P11-9648	CH06-11056 DON	P12-3770	ST09-12265 DON	P13-2566	CH06-11056 DON	P13-8999	CH04-11675 DON	P14-8823	ST08-12229 DON
P11-9649	ST-12226 DON	P12-4154	CH08-11003 DON	P13-2597	CH14-12245 DON	P14-0101	CH-12278 DON	P14-8967	CH05-11467 DON
P11-9674	CH08-11003 DON	P12-4156	CH05-11106 DON	P13-2598	SC-12252 DON	P14-0110	CH-12235 DON	P14-8969	CH05-11106 DON
P11-9677	SC-12274 DON	P12-4164	CH08-12228 DON	P13-2599	SC-12274 DON	P14-0122	CH-16873 DON	P14-8970	CH04-11675 DON
P11-9693	CH-12262 DON	P12-4173	CH08-11288 DON	P13-2601	CH14-12245 DON	P14-0123	CH-12385 DON	P15-0061	CH14-12245 DON
P11-9696	CH12-12251 DON	P12-4176	CH12-12251 DON	P13-2604	CH12-11389 DON	P14-0132	CH-12232 DON	P15-0135	PF-14090 DON
P11-9775	CH06-11038 DON	P12-4177	CH10-12224 DON	P13-2605	SC12-11391 DON	P14-0135	CH-12249 DON	P15-0135	PFM-14095 DON
P11-9776	CH05-11106 DON	P12-4179	CH-12653 DON	P13-2609	SC14-12254 DON	P14-0136	CH-12242 DON	P15-0610	CH08-11288 DON
P11-9778	ST09-12265 DON	P12-4525	CH-12276 DON	P13-2976	CH08-12243 DON	P14-0137	CH-12212 DON	P15-0611	CH06-14733 DON
P12-0022	CH09-12244 DON	P12-4526	SC10-11317 DON	P13-2977	CH05-11106 DON	P14-0185	CH-12238 DON	P15-0612	CH09-12244 DON
P12-0057	CH-12272 DON	P12-6334	CH10-11308 DON	P13-3138	SC10-12395 DON	P14-0186	CH-12231 DON	P15-0906	CH-12210 DON
P12-0058	CH-12271 DON	P12-6343	SC12-11391 DON	P13-3140	CH10-11308 DON	P14-0187	CH-12386 DON	P15-0907	CH-12208 DON
P12-0113	CH05-11106 DON	P12-6984	ST-12226 DON	P13-3149	CH16-12253 DON	P14-0237	CH21-17070 DON	P15-0908	CH-12214 DON
P12-0281	CH05-11467 DON	P12-7128	CH08-11003 DON	P13-3152	SC-12252 DON	P14-0537	CH04-11675 DON	P15-0909	CH-12207 DON
P12-0307	ST-13410 DON	P12-7532	CH-12276 DON	P13-3320	CH12-11389 DON	P14-0633	CH-12246 DON	P15-0921	CH-13141 DON
P12-0591	CH09-12244 DON	P12-7784	CH08-12228 DON	P13-3321	CH14-12245 DON	P141628	CH14-12245 DON	P15-0924	CH-12272 DON
P12-0841	CH16-12253 DON	P12-7787	ST08-12229 DON	P13-3322	SC12-11391 DON	P14-1629	SC14-12254 DON	P15-0925	CH-12271 DON
P12-0842	CH14-12245 DON	P12-8047	CH18-17230 DON	P13-3323	SC14-12254 DON	P14-1770	CH-12867 DON	P15-0933	CH-13157 DON
P12-0949	ST05-14980 DON	P12-8149	CH08-11288 DON	P13-3525	CH10-12224 DON	P14-2012	CH-12260 DON	P15-0934	CH-13156 DON
P12-1200	CH05-11106 DON	P12-8406	SC18-17232 DON	P13-3546	CH05-11106 DON	P14-2115	CH-12275 DON	P15-0935	CH-13150 DON
P12-1240	CH04-11675 DON	P12-8407	CH18-17230 DON	P13-4009	CH-12209 DON	P142141	CH-12386 DON	P15-1135	CH18-17230 DON
P12-1414	ST-12226 DON	P12-8408	SC18-17232 DON	P13-4020	CH-12212 DON	P142145	CH-12216 DON	P15-1145	CH08-11288 DON
P12-1415	ST06-11315 DON	P12-8517	SC-12274 DON	P13-4743	CH-12268 DON	P142146	CH-12215 DON	P15-1156	CH12-12251 DON
P12-1642	CH06-11056 DON	P12-8531	ST08-11110 DON	P13-6173	CH-12282 DON	P14-2742	CH-12269 DON	P15-1157	CH14-12245 DON
P12-1643	ST-12226 DON	P12-8846	CH-12215 DON	P13-6256	CH10-11308 DON	P14-2743	CH-12273 DON	P15-1179	CH06-14733 DON
P12-1673	CH10-11308 DON	P12-8852	CH-12216 DON	P13-6257	CH08-11003 DON	P14-2744	CH12-11389 DON	P15-1323	CH05-11106 DON
P12-1674	CH12-11389 DON	P12-8952	CH-12268 DON	P13-6259	CH06-11056 DON	P14-2746	SC21-17075 DON	P15-1596	CH-12273 DON
P12-1675	CH14-12245 DON	P12-9200	CH-12269 DON	P13-6390	CH-12209 DON	P14-2747	CH21-17070 DON	P15-1757	ST06-11315 DON
P12-2026	ST08-11316 DON	P12-9610	CH21-17070 DON	P13-6399	CH-12212 DON	P14-2750	SC-12274 DON	P15-1771	CH14-12245 DON
P12-2073	CH08-11288 DON	P13-0502	CH-12286 DON	P13-6657	SC-12274 DON	P14-2751	SC-12270 DON	P15-1774	CH08-11288 DON
P12-2074	ST08-11316 DON	P13-0760	CH06-11056 DON	P13-6658	CH21-17070 DON	P14-2752	SC-12252 DON	P15-1775	CH06-14733 DON
P12-2133	ST09-12265 DON	P13-0761	CH06-11056 DON	P13-6659	SC21-17075 DON	P14-2753	SC12-11391 DON	P15-1776	CH05-11467 DON
P12-2155	SC10-11317 DON	P13-0765	CH12-11389 DON	P13-6660	SC-12252 DON	P14-2755	ST09-12265 DON	P15-1777	CH18-17230 DON
P12-2156	SC12-11391 DON	P13-0771	CH-14104 DON	P13-6824	SC-12274 DON	P14-2756	CH09-12244 DON	P15-1874	CH-12264 DON
P12-2157	SC14-12254 DON	P13-0776	ST-12226 DON	P13-6840	CH05-11106 DON	P14314/1	CH08-11003 MTBR	P15-1903	SC14-12254 DON
P12-2329	CH12-11389 DON	P13-1280	CH14-13356 DON	P13-6989	CH-12269 DON	P14-3316	CH12-11389 DON	P15-1904	CH12-12251 DON
P12-2330	CH14-12245 DON	P13-1282	CH09-12244 DON	P13-6990	SC-12270 DON	P14-3571	CH04-11675 DON	P15-1905	ST09-12265 DON

Number Finder



MFRS. NO.	OUR NO. MFR	MFRS. NO.	OUR NO. MFR	MFRS. NO.	OUR NO. MFR	MFRS. NO.	OUR NO. MFR	MFRS. NO.	OUR NO. MFR
P15-1906	CH09-12244 DON	P17-0180	CH06-11880 DON	P18-2072	CH05-11467 DON	P52-7829	CH-12289 DON	P77-0666	CH12-11343 DON
P15-1910	SC10-11317 DON	P-17064	CH-12262 DON	P18-2090	CH-12276 DON	P52-8221	CH-12206 DON	P77-0666	CH-13477 DON
P15-1915	CH-12260 DON	P18-1007	CH-12268 DON	P18-2092	CH-12286 DON	P52-8225	PF-15684 DON	P77-0677	CH-12794 DON
P15-1917	SC-12274 DON	P18-1033	CH-12262 DON	P182173	CH14-12245 DON	P52-9556	ST-13410 DON	P77-0709	CH-15300 DON
P15-1918	CH-12273 DON	P18-1034	CH12-11389 DON	P18-4033	CH-12262 DON	P52-9596	CH16-12253 DON	P77-0734	CH-12798 DON
P15-1921	CH14-12245 DON	P18-1035	CH12-12251 DON	P18-4034	CH12-11389 DON	P53-1034	ST-13531 DON	P77-0736	SC14-12254 DON
P15-1951	CH-12234 DON	P18-1036	CH-12260 DON	P18-4035	CH12-12251 DON	P53-2003	ST-13529 DON	P77-0739	CH14-12245 DON
P15-1966	SC18-17232 DON	P18-1041	CH-12273 DON	P18-4036	CH-12260 DON	P53-2006	ST-16488 DON	P77-0800	CH-12790 DON
P15-2038	CH-12385 DON	P18-1042	CH18-17230 DON	P18-4041	CH-12273 DON	P53-2007	ST-13531 DON	P77-0833	CH10-12390 DON
P15-2302	ST05-14980 DON	P18-1044	CH-12269 DON	P18-4042	CH18-17230 DON	P53-2008	ST-13527 DON	P77-0833	CH10-14455 DON
P15-2576	CH14-12245 DON	P18-1046	CH14-12245 DON	P18-4044	CH-12269 DON	P53-2012	CH-12980 DON	P77-0834	CH-12345 DON
P15-2583	CH14-12245 DON	P18-1050	CH05-11106 DON	P18-4046	CH14-12245 DON	P53-2021	CH-12209 DON	P77-0954	CH-14237 DON
P15-2643	CH05-11106 DON	P18-1059	CH08-11288 DON	P18-5002	CH16-12253 DON	P53-3332	CH-12716 DON	P77-1004	CH-14104 DON
P15-2644	CH08-11288 DON	P18-1062	CH06-14733 DON	P18-5034	CH12-11389 DON	P53-5089	PF-15686 DON	P77-1006	CH-12275 DON
P15-2647	CH04-11675 DON	P18-1063	CH09-12244 DON	P18-5039	CH-12266 DON	P53-5332	ST07-14270 DON	P77-1174	SC-15604 DON
P15-2648	CH12-12251 DON	P18-1064	CH10-11308 DON	P18-5040	CH21-17070 DON	P53-5362	CH-12716 DON	P77-1504	CH-12276 DON
P15-2652	CH09-12244 DON	P18-1072	CH05-11467 DON	P18-5041	CH-12273 DON	P53-7876	CH-16689 DON	P77-1507	CH-16873 DON
P15-2654	CH06-14733 DON	P18-1088	CH-12386 DON	P18-5042	CH18-17230 DON	P53-8494	CH05-15887 DON	P77-1508	CH-12242 DON
P15-2655	CH10-11308 DON	P18-1089	CH-12231 DON	P18-5044	CH-12269 DON	P53-9465	CH-12213 DON	P77-1509	CH-12238 DON
P15-2656	CH05-11467 DON	P18-1090	CH-12276 DON	P18-5046	CH14-12245 DON	P53-9466	CH-12091 DON	P77-1510	CH-12246 DON
P15-2659	CH12-11389 DON	P18-1092	CH-12286 DON	P-18706	CH-12210 DON	P55-5089	PF-15686 DON	P77-1511	CH10-11117 DON
P15-2712	ST-13410 DON	P18-1102	CH-12210 DON	P-18709	CH-12208 DON	P-55591	CH12-11389 LRN	P77-1515	CH-12752 DON
P15-2714	ST09-12265 DON	P18-1103	CH-12208 DON	P-19159	CH-12214 DON	P-55596	CH12-11389 LRN	P77-1516	CH-12248 DON
P15-2716	SC12-11391 DON	P18-1104	CH-12214 DON	P-19167	CH-12207 DON	P-55602	SC12-11391 LRN	P77-1519	CH-12282 DON
P15-2718	SC10-11317 DON	P18-1105	CH-12207 DON	P20505-09	CH-12214 PCLN	P-55605	CH14-12245 LRN	P77-1520	CH-12794 DON
P15-3336	CH-12266 DON	P18-1116	CH-12260 DON	P2150506	SC10-12395 CASE	P-55606	SC14-12254 LRN	P77-1521	CH-15300 DON
P15-3351	CH12-12251 DON	P18-1119	CH-12271 DON	P250566	ST06-11315 CASE	P7271/1	CH05-11106 MTBR	P77-1522	CH-12798 DON
P15-3352	CH12-11389 DON	P18-1126	CH-12403 DON	P250581	ST08-11316 CASE	P77-0027	CH-12283 DON	P77-1527	CH12-11343 DON
P15-3353	SC12-11391 DON	P18-1137	CH-12235 DON	P-250599	CH09-12244 CASE	P77-0035	CH-11211 DON	P77-1527	CH-13477 DON
P15-3354	CH14-12245 DON	P18-1173	CH14-12245 DON	P26510192	CH05-11106 FAIEX	P77-0145	CH06-11056 DON	P77-1528	CH-12250 DON
P15-3355	CH10-11308 DON	P18-1184	CH-12235 DON	P26510214	CH08-11288 FAIEX	P77-0180	CH06-11880 DON	P77-1528	CH-16874 DON
P15-3356	SC14-12254 DON	P18-1186	CH-11020 DON	P-2881	CH-12262 DMMNDT	P77-0181	ST06-12048 DON	P77-1529	CH08-11942 DON
P15-3358	CH04-11675 DON	P18-1206	CH-12091 DON	P-2881	CH-12262 WHITE	P77-0197	CH08-11935 DON	P77-1530	CH-12790 DON
P15-3359	CH05-11106 DON	P18-2002	CH16-12253 DON	P-29748	CH12-11389 FRAM	P77-0198	ST08-11316 DON	P77-1531	CH-12345 DON
P15-3361	SC10-11317 DON	P18-2034	CH12-11389 DON	P-29870	CH-12266 FRAM	P77-0221	CH-12752 DON	P77-1532	CH-14237 DON
P15-3386	CH14-13356 DON	P18-2036	CH-12260 DON	P-31488	CH-12235 FRAM	P77-0227	CH-12660 DON	P77-1534	CH-14104 DON
P15-4003	ST-14343 DON	P18-2039	CH-12266 DON	P-33058	CH-12289 FRAM	P77-0234	CH-12250 DON	P77-1537	CH-12653 DON
P15-4631	ST-14343 DON	P18-2040	CH21-17070 DON	P398991	CH05-11106 T-K	P77-0234	CH-16874 DON	P77-1545	CH10-11308 DON
P15-4632	CH08-11288 DON	P18-2041	CH-12273 DON	P450543	CH-12276 CASE	P77-0364	CH-13074 DON	P77-1549	CH06-11880 DON
P15-5334	ST08-11316 DON	P18-2042	CH18-17230 DON	P450544	SC10-11317 CASE	P77-0367	CH08-11942 DON	P77-1550	CH08-11935 DON
P15-5698	SC18-17232 DON	P18-2044	CH-12269 DON	P-47629	CH08-12243 ASTR	P77-0373	CH05-11106 DON	P77-1551	CH-12660 DON
P15-8182	CH-12385 DON	P18-2045	CH10-12224 DON	P-49360	CH08-12243 ASTR	P77-0382	CH-13050 DON	P77-1552	CH-13074 DON
P15-8557	CH08-11288 DON	P18-2046	CH14-12245 DON	P52-2450	CH-12605 DON	P77-0414	CH-12276 DON	P77-1553	CH08-14835 DON
P15-8661	CH-13157 DON	P18-2050	CH05-11106 DON	P52-2839	CH-12242 DON	P77-0494	SC10-11317 DON	P77-1555	CH10-12390 DON
P15-8662	CH-13156 DON	P18-2052	CH06-11038 DON	P52-4382	PF-15683 DON	P77-0495	ST09-12265 DON	P77-1555	CH10-14455 DON
P15-8663	CH-13150 DON	P18-2054	CH08-11003 DON	P52-5027	CH04-11675 DON	P77-0504	CH-12248 DON	P77-1556	CH-14386 DON
P15-8669	CH-13141 DON	P18-2062	CH06-14733 DON	P52-6504	CH-12867 DON	P77-0520	SC10-11317 DON	P77-1557	CH-12225 DON
P15-8671	CH-12272 DON	P18-2063	CH09-12244 DON	P52-6660	CH06-14733 DON	P77-0576	CH-12282 DON	P77-1558	CH-12278 DON
P160558	CH08-12243 DON	P18-2064	CH10-11308 DON	P52-6755	CH10-11308 DON	P77-0589	CH08-17365 DON	P77-1561	CH-12385 DON

Number Finder



MFRS. NO.	OUR NO. MFR	MFRS. NO.	OUR NO. MFR	MFRS. NO.	OUR NO. MFR	MFRS. NO.	OUR NO. MFR	MFRS. NO.	OUR NO. MFR
P77-1562	CH-12275 DON	P77-4551	CH-15304 DON	P77-7654	CH-15475 DON	P81-2016	CH10-11308 DON	P90-0250	CH-12272 DON
P77-1563	CH-12247 DON	P77-4552	CH-15300 DON	P77-7655	CH-15475 DON	P81-2204	CH12-11389 DON	P90-0349	CH-12289 DON
P77-1564	CH08-12228 DON	P77-4576	CH-15294 DON	P77-7868	CH-16294 DON	P81-2223	CH12-11389 DON	P90-0433	CH08-11288 DON
P77-1572	CH-13404 DON	P77-4578	CH-13473 DON	P77-7869	SC-16301 DON	P81-2405	CH14-12245 DON	P90-0434	ST06-11315 DON
P77-1575	CH-12387 DON	P77-4583	SC14-12254 DON	P77-7871	CH-16521 DON	P81-2408	CH14-12245 DON	P90-0635	CH-12225 DON
P77-1583	CH-12247 DON	P77-5064	CH-12507 DON	P77-7875	SC-16522 DON	P81-2506	CH05-11106 DON	P90-0685	CH-12225 DON
P77-1593	CH-12285 DON	P77-5074	CH-12507 DON	P77-8131	ST-16876 DON	P81-2513	CH-12770 DON	P90-0715	CH14-12245 DON
P77-1594	CH-12091 DON	P77-5298	ST05-14402 DON	P77-8335	CH-14896 DON	P81-2600	CH16-12253 DON	P90-0717	SC14-12254 DON
P77-2504	CH-12276 DON	P77-5300	ST07-14270 DON	P77-8336	CH-14902 DON	P81-2602	CH16-12253 DON	P90-0763	CH-12272 DON
P77-2519	CH-12282 DON	P77-5302	ST08-14413 DON	P77-8404	CH-12397 DON	P81-4539	SC12-11391 DON	P90-0799	CH-12247 DON
P77-2520	CH-12794 DON	P77-5339	SC-15681 DON	P77-8441	CH-14107 DON	P81-4723	CH-12770 DON	P90-0830	CH10-11308 DON
P77-2521	CH-15300 DON	P77-5366	ST-16488 DON	P77-8472	CH-12236 DON	P81-5267	CH-12739 DON	P90-0831	SC10-11317 DON
P77-2522	CH-12798 DON	P77-5367	ST-16487 DON	P77-8509	CH-14387 DON	P81-5288	CH08-11935 DON	P90-0832	CH-12604 DON
P77-2527	CH12-11343 DON	P77-5368	ST-13530 DON	P78-0272	CH-13185 DON	P-81571	CH05-11106 ASTR	P90-0833	CH-12605 DON
P77-2527	CH-13477 DON	P77-5369	ST-13527 DON	P78-0522	CH09-16729 DON	P81-5840	CH04-11675 DON	P90-0836	CH08-11288 DON
P77-2529	CH08-11942 DON	P77-5370	ST-13529 DON	P78-0523	ST09-16731 DON	P81-5850	CH05-11106 DON	P90-0929	CH-12790 DON
P77-2530	CH-12790 DON	P77-5371	ST-13528 DON	P78-0622	CH-16523 DON	P815851	CH05-11106 DON	P90-0942	CH-12794 DON
P77-2531	CH-12345 DON	P77-5372	ST-13531 DON	P78-0647	CH07-14074 DON	P81-5852	CH05-11106 DON	P90-1512	CH-13157 DON
P77-2532	SC10-11317 DON	P77-5457	ST08-14829 DON	P78-0910	CH-16689 DON	P81-5861	CH06-11038 DON	P90-1514	CH-13156 DON
P77-2534	CH-14104 DON	P77-5500	SC-15604 DON	P78-1039	CH10-15371 DON	P81-5880	CH08-11288 DON	P90-1516	CH-13150 DON
P77-2545	CH10-11308 DON	P77-5631	CH05-14409 DON	P78-1741	CH-16922 DON	P81-5881	CH08-11288 DON	P90-1524	CH-12208 DON
P77-2549	CH06-11880 DON	P77-5687	CH-12770 DON	P78-1911	CH08-14410 DON	P82-1575	CH05-15887 DON	P90-1526	CH-12214 DON
P77-2550	CH08-11935 DON	P77-5704	ST-16879 DON	P78-2099	CH-16294 DON	P82-2143	SC12-11391 DON	P90-1528	CH-12207 DON
P77-2552	CH-13074 DON	P77-5739	CH-12386 DON	P78-4015	PF-15700 DON	P82-2144	SC14-12254 DON	P90-1530	CH-12271 DON
P77-2553	CH08-14835 DON	P77-5792	CH-12231 DON	P78-4574	PF-15701 DON	P82-2686	CH04-14412 DON	P90-1546	CH-12210 DON
P77-2555	CH10-12390 DON	P77-5803	CH-12507 DON	P80-1843	CH10-11308 DON	P82-2768	CH06-16050 DON	P90-1550	CH-13141 DON
P77-2555	CH10-14455 DON	P77-5804	CH-15304 DON	P80-2507	SC-12252 DON	P82-2769	ST06-16054 DON	P90-3914	CH14-12245 DON
P77-2564	CH08-12228 DON	P77-5843	CH-13763 DON	P80-2781	SC14-12254 DON	P82-2858	ST05-16108 DON	PA-1621-2-OP	CH-12262 BALD
P77-2565	CH-13075 DON	P77-6260	CH-12825 DON	P80-3914	CH14-12245 DON	P-82301	CH05-11106 ASTR	PA-1621-OPC	CH-12262 BALD
P77-2578	CH05-14409 DON	P77-6284	CH10-12390 DON	P80-3915	CH14-12245 DON	P82-3333	ST08-14413 DON	PA-1634	CH-12214 BALD
P77-2579	CH07-14074 DON	P77-6284	CH10-14455 DON	P80-4874	SC14-12254 DON	P82-6982	SC12-11391 DON	PA-1646-FN	CH12-12251 BALD
P77-2580	CH08-14410 DON	P77-6358	CH06-11941 DON	P80-6412	ST-14343 DON	P82-7653	CH-17490 DON	PA-1647	CH-13157 BALD
P77-2581	CH-15673 DON	P77-6565	ST06-11109 DON	P80-6426	CH14-12245 DON	P82-7655	CH-15475 DON	PA-1649	CH-12260 BALD
P77-2585	CH-15294 DON	P77-6694	ST-13530 DON	P80-6660	SC-12252 DON	P82-8889	CH08-17365 DON	PA-1649-OPC	CH-12260 BALD
P77-2586	CH-15565 DON	P77-6695	ST-13531 DON	P80-6766	SC14-12254 DON	P82-9332	ST07-14270 DON	PA-1669	CH-12210 BALD
P77-2587	CH-14154 DON	P77-6696	ST-13527 DON	P80-6767	CH14-12245 DON	P82-9333	ST08-17366 DON	PA-1670	CH-13150 BALD
P77-2597	CH-13473 DON	P77-6697	ST-13529 DON	P80-7219	CH14-12245 DON	P-850501	ST09-12265 CASE	PA-1673	CH-12207 BALD
P77-3521	CH-12282 DON	P77-6745	CH-16523 DON	P80-7335	SC14-13357 DON	P-850550	SC-12270 CASE	PA-1675	CH-13156 BALD
P77-3605	CH-13270 DON	P77-6895	ST-14787 DON	P80-7336	CH14-13356 DON	P-850551	CH-12269 CASE	PA-1683	CH-12209 BALD
P77-4501	CH-15565 DON	P77-7279	CH-16689 DON	P80-7628	ST-12226 DON	P-850561	SC12-11391 CASE	PA-1690-FN	CH05-11106 BALD
P77-4502	CH12-11389 DON	P77-7408	SC-16290 DON	P80-7641	CH06-11056 DON	P-850562	CH12-11389 CASE	PA-1718	CH-12206 BALD
P77-4504	CH-12276 DON	P77-7409	CH-14888 DON	P80-9315	CH14-12245 DON	P-850568	CH-12273 CASE	PA-1719	CH-12177 BALD
P77-4505	CH-12269 DON	P77-7414	SC-16290 DON	P81-1004	CH10-11308 DON	P-850569	SC-12274 CASE	PA-1753-FN	CH08-12221 BALD
P77-4509	CH08-11935 DON	P77-7523	ST-16488 DON	P81-1200	CH12-12251 DON	P-85059	CH09-12244 ASTR	PA-1765	PF-15677 BALD
P77-4518	CH14-12245 DON	P77-7524	ST-16487 DON	P81-1203	CH12-11389 DON	P85148	ST-13410 ATHY	PA-1794-FN	CH-12275 BALD
P77-4521	CH-12282 DON	P77-7551	ST-13528 DON	P81-1213	CH12-12251 DON	P85149	CH05-11467 ATHY	PA-1822-FN	CH08-11288 BALD
P77-4524	CH14-12245 DON	P77-7579	CH-14900 DON	P81-1413	CH14-12245 DON	P85842	CH12-11389 ATHY	PA-1865-FN	CH04-11675 BALD
P77-4538	CH-12798 DON	P77-7638	CH-16928 DON	P81-1500	CH05-11106 DON	P85843	SC12-11391 ATHY	PA-1865N	CH04-11675 BALD
P77-4550	CH08-11935 DON	P77-7639	ST10-15380 DON	P81-2004	CH10-12224 DON	P90-0152	CH-12231 DON	PA-1868	CH-12212 BALD

Number Finder



MFRS. NO.	OUR NO. MFR	MFRS. NO.	OUR NO. MFR	MFRS. NO.	OUR NO. MFR	MFRS. NO.	OUR NO. MFR	MFRS. NO.	OUR NO. MFR
PA-1878	CH-12403 BALD	PA-2554	PF-14090 BALD	PA2869	CH-12213 BALD	PA3807	CH-12236 BALD	PAK-939	CH06-11056 PERY
PA-1884	CH12-11389 BALD	PA-2554	PFM-14095 BALD	PA2888	CH-12809 BALD	PA3808-FN	CH-13473 BALD	PAK-988	CH08-11288 PERY
PA-1885	CH14-12245 BALD	PA-2562	CH18-17230 BALD	PA2891	CH-12248 BALD	PA3839	PF-15441 BALD	PAK-992	CH10-11308 PERY
PA-1886	CH-12273 BALD	PA-2563	SC18-17232 BALD	PA2911	CH-12231 BALD	PA3842	PF-15690 BALD	PAT-44377	CH08-11003 JDEER
PA-1889	CH-12847 BALD	PA-2570	ST08-11110 BALD	PA2912	CH-12870 BALD	PA3843	PF-15693 BALD	PBC-257001	CH-12209 CVTR
PA-1893	SC14-12254 BALD	PA-2571	PF-14090 FRAM	PA2917	CH-16873 BALD	PA3848FN	CH-13811 BALD	PC-10	CH-12209 AC
PA-1895	CH-12269 BALD	PA-2571	PFM-14095 FRAM	PA2964	CH-12225 BALD	PA3849	CH-12790 BALD	PC-125	CH-12249 AC
PA-1902-FN	CH10-11308 BALD	PA-2588	CH-12867 BALD	PA2976FN	CH06-11880 BALD	PA3850	CH12-11343 BALD	PC-134K	CH12-12251 AC
PA-1904	SC-12274 BALD	PA-2602	ST-13410 BALD	PA2977-FN	CH-13270 BALD	PA3850	CH-13477 BALD	PC-135	CH14-12245 AC
PA-1906	SC-12270 BALD	PA-2608	CH-11020 BALD	PA2978	CH-12206 BALD	PA3854FN	CH10-12390 BALD	PC-138	CH05-11106 AC
PA-1907-FN	CH05-12222 BALD	PA-2641	CH-12276 BALD	PA-302	PF-14090 PERY	PA3854FN	CH10-14455 BALD	PC-138K	CH05-11106 AC
PA-1911	SC12-11391 BALD	PA-2645	CH-14334 BALD	PA-302	PFM-14095 PERY	PA3855FN	CH-12345 BALD	PC-139	CH-12653 AC
PA-1912	SC10-11317 BALD	PA-2649	CH-12289 BALD	PA3405	CH-12857 BALD	PA3859	CH-13075 BALD	PC-140	CH-12262 AC
PA-1919	SC10-11317 BALD	PA-2653	CH-12403 BALD	PA3414	PF-15686 BALD	PA3860	CH-12794 BALD	PC-177	CH-12231 AC
PA-1940	CH-14104 BALD	PA-2664	CH-12604 BALD	PA3427	CH-12660 BALD	PA3866	ST06-11109 BALD	PC-178	CH-12980 AC
PA-1981	SC10-12395 BALD	PA-2665	CH-12605 BALD	PA3428	CH08-11935 BALD	PA4082	CH-12272 BALD	PC-179	CH-12386 AC
PA-2	PF-15677 FRAM	PA-2669-FN	CH08-12228 BALD	PA3437	CH-13811 BALD	PA-474	CH08-12243 PERY	PC-181	CH-12212 AC
PA-2001	CH-12206 BALD	PA-2670	ST08-12229 BALD	PA3476	CH-12716 BALD	PA-480	CH05-11106 PERY	PC-183	CH-12385 AC
PA-2103	PF-15684 BALD	PA-2707	CH-12283 BALD	PA3477	CH-16873 BALD	PA-497	CH-12210 PERY	PC-185	CH-12242 AC
PA-2104	PF-15683 BALD	PA-2713	PF-15680 FRAM	PA3491	CH-14722 BALD	PA-498	CH-13150 PERY	PC-186	CH-12248 AC
PA2222	PF-15856 BALD	PA-2727	CH-12491 BALD	PA3492	ST-14715 BALD	PA-499	CH-12214 PERY	PC-187	CH-12235 AC
PA-2310	CH-13141 BALD	PA-2728	CH-12485 BALD	PA3494	ST-13528 BALD	PA-589	CH-12403 PERY	PC-188	CH-12177 AC
PA-2312	CH-12268 BALD	PA2757	CH-11211 BALD	PA3558	CH-15304 BALD	PA-597	CH-12207 PERY	PC-190	CH-12260 AC
PA-2331	CH-12209 BALD	PA2764	CH-12653 BALD	PA3566	CH-12507 BALD	PA-598	CH-13157 PERY	PC-196	CH-12397 AC
PA-2332	ST06-11315 BALD	PA-2765	CH-12397 BALD	PA3572	CH-12238 BALD	PA-599	CH-12208 PERY	PC-197	CH-12238 AC
PA-2337	CH-12249 BALD	PA-2767	CH-12231 BALD	PA3593	CH-12387 BALD	PA-600	CH-13156 PERY	PC-200	CH-12234 AC
PA-2344-FN	CH05-11467 BALD	PA-2768-FN	CH08-12228 BALD	PA3597	CH-12825 BALD	PA-608	PF-14090 BALD	PC-212	CH-12091 AC
PA-2345	CH14-13356 BALD	PA-2769	ST08-12229 BALD	PA3605	CH-12234 BALD	PA-608	PFM-14095 BALD	PC-215	CH-12235 AC
PA-2346	SC14-13357 BALD	PA2770	PF-15680 BALD	PA3612	CH-12397 BALD	PA-695	CH-12209 PERY	PC-217	CH-12177 AC
PA-2360-FN	CH06-14733 BALD	PA-2772	CH-12285 BALD	PA3653	CH-12216 BALD	PA-7001	PF-15684 FIAM	PC-299K	CH08-11288 AC
PA-2380-FN	CH06-11056 BALD	PA2773	CH-12302 BALD	PA3654	CH-12215 BALD	PA-706	CH-12275 PERY	PC-33	CH-12206 AC
PA-2381	ST-12226 BALD	PA-2776	CH-12278 BALD	PA-3669-FN	CH08-11935 BALD	PA-789	CH-14104 PERY	PC-331	CH10-11308 AC
PA-2398	CH-12282 BALD	PA-2783	CH-12286 BALD	PA3675	CH-12798 BALD	PA-834	CH-12268 PERY	PC-333	SC10-11317 AC
PA-2405	CH-12385 BALD	PA-2790-FN	CH06-11941 BALD	PA3682	ST-16880 BALD	PA-835	CH14-12245 PERY	PC-334	CH09-12244 AC
PA-2413	CH-12272 BALD	PA-2801	CH-12264 BALD	PA3683	ST-16876 BALD	PA-836	CH12-11389 PERY	PC-347	CH-12213 AC
PA-2416	CH-12386 BALD	PA2808	CH-12781 BALD	PA3684	ST-16879 BALD	PA-929	CH-12209 PERY	PC-360	PF-15684 AC
PA-2418-FN	CH08-11288 BALD	PA-2810	CH-13050 BALD	PA3686	ST-16487 BALD	PA-972	CH-12273 PERY	PC-370	CH-12213 AC
PA-2419	ST08-11316 BALD	PA-2812	CH-12246 BALD	PA3687	ST-16488 BALD	PA-975	CH05-12222 PERY	PC-378	CH-12247 AC
PA-2420	CH08-11288 BALD	PA-2813	CH-12387 BALD	PA3688	CH-15300 BALD	PAK-480	CH05-11106 PERY	PC-389	CH-12225 AC
PA-2422	CH-12091 BALD	PA-2814	ST-13529 BALD	PA3690	CH08-11942 BALD	PAK-530	CH-12262 PERY	PC-390	CH-12285 AC
PA-2423	CH-12225 BALD	PA-2833	CH-15565 BALD	PA3698	CH-12271 BALD	PAK-532	CH-12262 PERY	PC-400	CH-12247 AC
PA-2426-FN	CH09-12244 BALD	PA-2834	SC-15604 BALD	PA3699	CH-15294 BALD	PAK-568	CH-12260 PERY	PC-41	CH-11348 AC
PA-2427	ST09-12265 BALD	PA2835	ST-13531 BALD	PA3752	CH-12980 BALD	PAK-591	CH12-12251 PERY	PC-411	ST08-11316 AC
PA-2453	CH21-17070 BALD	PA2836	ST-13527 BALD	PA3752	CH-11789 BALD	PAK-703	CH08-12221 PERY	PC-420	CH-12236 AC
PA-2454	SC21-17075 BALD	PA2837	ST-13530 BALD	PA3753	CH-12980 BALD	PAK-705	CH08-11288 PERY	PC-421	CH-12246 AC
PA-2474	CH-12242 BALD	PA2838	CH-12247 BALD	PA3754	CH-13763 BALD	PAK-706	CH-12275 PERY	PC-422	CH-12826 AC
PA-2475	CH-12235 BALD	PA2845	CH-12386 BALD	PA3772	CH-12093 BALD	PAK-826	ST-12226 PERY	PC-437	CH-12264 AC
PA-2489	ST-14343 BALD	PA2862	CH-12953 BALD	PA3779FN	CH08-12228 BALD	PAK-827	CH05-11467 PERY	PC-445	CH-11211 AC
PA-2541-FN	CH06-11295 BALD	PA2866	CH-12232 BALD	PA3787	ST-17470 BALD	PAK-925	CH14-13356 PERY	PC-49	PF-15680 AC

Number Finder



MFRS. NO.	OUR NO. MFR	MFRS. NO.	OUR NO. MFR	MFRS. NO.	OUR NO. MFR	MFRS. NO.	OUR NO. MFR	MFRS. NO.	OUR NO. MFR
PC-67	CH-12249 AC	PEA-549	CH-12216 PURO	PM-1707	CH-12246 PURO	PMA-4M9335	CH-13156 CYCL	QSA-229	CH-12209 OS
PC-75	CH-12250 AC	PEA-559	SC12-11391 PURO	PM-1709	CH-12385 PURO	PMA-4M9378	CH-12207 CYCL	QSA-233	CH-12210 OS
PC-75	CH-16874 AC	PEA-562	CH-12249 PURO	PM-1714	CH-12247 PURO	PMA-6500HD	CH-12847 CYCL	QSA-234	CH-13150 OS
PC-88	CH12-11389 AC	PF-60011	CH05-11106 PRKN	PM-1715	CH-12236 PURO	PMA-722HD	CH-12271 CYCL	QSA-236	CH-13156 OS
PCA1532	CH06-14733 CONTI	PF60053	CH12-12251 PRKN	PM-175	CH-12235 PURO	PMA-7M9045	CH-12210 CYCL	QSA-237	CH-13157 OS
PCA1543SY	ST06-11315 CONTI	PF60999	ST-14183 PRKN	PM-1750	CH-12235 PURO	PMA-7M9046	CH-13150 CYCL	QSA-244	CH-12260 OS
PCA1544SY	ST08-11316 CONTI	PG621523301	CH14-12245 AVBA	PM-1758	CH-12397 PURO	PO-11913	CH12-12251 LRN	QSA-252	CH-12262 OS
PCA1570	CH21-17070 CONTI	PG621523302	SC14-12254 AVBA	PM-1760	CH-12278 PURO	PX 102	CH12-11389 PIPRC	QSA-265	CH-12262 OS
PCA1570SY	SC21-17075 CONTI	PI02619	ST10-11239 PRKN	PM-1761	CH-12238 PURO	PX 1030	CH08-12228 PIPRC	QSA-3307	CH-12847 OS
PCA216	CH-12207 CONTI	PI02620	ST12-11390 PRKN	PM-1762	CH-12231 PURO	PX 104	CH06-11038 PIPRC	QSA-3441	PF-15684 OS
PCA224	CH-12208 CONTI	PI02673	ST06-11315 PRKN	PM-2080	CH08-11288 PURO	PX 105	CH05-11106 PIPRC	QSA-3559	PF-15683 OS
PCA226	CH-12214 CONTI	PI02679	CH08-11288 PRKN	PMA-10-0890K	CH-12262 CYCL	PX 1052	ST-16488 PIPRC	QSA-507	CH14-12245 OS
PCA226SY	CH-13141 CONTI	PI02688	ST08-11316 PRKN	PMA-10-1237	CH12-12251 CYCL	PX 1053	ST-16487 PIPRC	QSA-507-SY	SC14-12254 OS
PCA229	CH-12209 CONTI	PI026880	ST08-11316 PRKN	PMA-10-1237K	CH12-12251 CYCL	PX 106	CH-12242 PIPRC	QSA-523	CH12-11389 OS
PCA233	CH-12210 CONTI	PI02689	ST09-12265 PRKN	PMA-10-1246	CH08-12243 CYCL	PX 108	CH-12246 PIPRC	QSA-523-SY	SC12-11391 OS
PCA234	CH-13150 CONTI	PI02707	SC10-11317 PRKN	PMA-10-1275K	CH05-11106 CYCL	PX 109	CH14-12245 PIPRC	QSA-535	CH-12273 OS
PCA236	CH-13156 CONTI	PI02871	CH05-11555 PRKN	PMA-10-2090K	CH-12260 CYCL	PX 110	CH-12385 PIPRC	QSA-535-SY	SC-12274 OS
PCA237	CH-13157 CONTI	PI02876	CH10-11117 PRKN	PMA-10-2745	CH04-11675 CYCL	PX 111	CH10-12224 PIPRC	QSA-546-SY	SC10-11317 OS
PCA244	CH-12260 CONTI	PI02912	ST08-11110 PRKN	PMA-10-2745K	CH04-11675 CYCL	PX 112	CH12-12251 PIPRC	QSA-563	CH-12269 OS
PCA2523	CH09-12244 CONTI	PI02913	ST08-11316 PRKN	PMA-10-3951	PF-15677 CYCL	PX 115	CH08-11288 PIPRC	QSA-563-SY	SC-12270 OS
PCA2523SY	ST09-12265 CONTI	PI02914	ST05-11108 PRKN	PMA-10-5043K	CH08-12221 CYCL	PX 118	CH-12826 PIPRC	QSA-586	CH-14104 OS
PCA254	CH10-12224 CONTI	PI02916	ST05-11618 PRKN	PMA-10-5054K	CH-12275 CYCL	PX 120	CH-12213 PIPRC	QSA-597	CH-12268 OS
PCA256	CH05-11106 CONTI	PI02917	CH08-11935 PRKN	PMA-10-5368K	CH08-11288 CYCL	PX 122	CH-12289 PIPRC	QSAK-1531	CH05-11467 OS
PCA2571	PF-14090 CONTI	PI02924	SC12-11391 PRKN	PMA-10-6587	CH12-11389 CYCL	PX 123	CH-12235 PIPRC	QSAK-1544	CH08-11288 OS
PCA2571	PFM-14095 CONTI	PI02927	CH06-11056 PRKN	PMA-10-6769	CH14-12245 CYCL	PX 124	CH-11211 PIPRC	QSAK-1563	CH05-11106 OS
PCA258	CH08-11003 CONTI	PI02928	ST-12226 PRKN	PMA-10-6775	SC14-12254 CYCL	PX 127	CH-12214 PIPRC	QSAK-255	CH12-12251 OS
PCA2595	CH18-17230 CONTI	PI02929	ST06-12048 PRKN	PMA-10-8668K	CH10-11308 CYCL	PX 128	CH-12264 PIPRC	QSAK-256	CH05-11106 OS
PCA2595SY	SC18-17232 CONTI	PI02930	CH06-11880 PRKN	PMA-10-8674	SC10-11317 CYCL	PX 134	CH-16873 PIPRC	QSAK-508	CH-12275 OS
PCA3280	CH-12235 CONTI	PI02931	CH07-14074 PRKN	PMA-10-8736	CH05-12222 CYCL	PX 140	CH-12273 PIPRC	QSAK-510	CH08-12221 OS
PCA3660	PF-15684 CONTI	PI02932	ST07-14270 PRKN	PMA-10-9085	SC-12274 CYCL	PX 142	CH-12283 PIPRC	QSAK-530	CH04-11675 OS
PCA502	CH-12283 CONTI	PM-1042	CH-12953 PURO	PMA-10-9200	CH-12269 CYCL	PX 144	CH10-11308 PIPRC	QSAK-546	CH10-11308 OS
PCA502SY	SC-12252 CONTI	PM-1058	CH-12209 PURO	PMA-10-9206	SC-12270 CYCL	PX 149	CH-12248 PIPRC	QSAK-553	CH05-12222 OS
PCA507	CH14-12245 CONTI	PM-1073	CH-12091 PURO	PMA-11-7092	CH-12282 CYCL	PX 158	CH-12752 PIPRC	QSAK-565	CH08-11288 OS
PCA507SY	SC14-12254 CONTI	PM-1087	CH-12216 PURO	PMA-11-7781	SC21-17075 CYCL	PX 175	CH-12234 PIPRC	R01000/89	CH-12177 CMPR
PCA510	CH08-12221 CONTI	PM-1088	CH-12215 PURO	PMA-11-7782	CH21-17070 CYCL	PX 859	CH-12980 PIPRC	R-1050	CH-12278 ROMA
PCA523	CH12-11389 CONTI	PM-1102	SC12-11391 PURO	PMA-11-7797	CH-12268 CYCL	PX 938	CH14-12245 PIPRC	R-1070	CH-12249 ROMA
PCA523SY	SC12-11391 CONTI	PM-1123	ST08-11316 PURO	PMA-11-8211	CH14-13356 CYCL	PZA-117	PF-15684 PNZO	R-1096-S	SC10-11317 ROMA
PCA535	CH-12273 CONTI	PM-1139	ST06-11315 PURO	PMA-11-8216	SC14-13357 CYCL	PZA-123	PF-15683 PNZO	R-1185	CH-12264 ROMA
PCA535SY	SC-12274 CONTI	PM-1141	ST08-11316 PURO	PMA-11-9649	ST-12226 CYCL	Q01505-49	CH12-12251 PCLN	R-28797	CH10-11308 CASE
PCA536	CH-12266 CONTI	PM-1151	CH-12250 PURO	PMA-1424HD	CH12-11389 CYCL	Q02505-99	CH09-12244 PCLN	R-29295	CH10-11308 CASE
PCA546	CH10-11308 CONTI	PM-1151	CH-16874 PURO	PMA-17064K	CH-12262 CYCL	QSA-1543-SY	ST06-11315 OS	R-3005	SC12-11391 ROMA
PCA546SY	SC10-11317 CONTI	PM-1568	CH-12242 PURO	PMA-192HD	CH-12177 CYCL	QSA-1544-SY	ST08-11316 OS	R-36361	SC10-11317 CASE
PCA563	CH-12269 CONTI	PM-1574	CH-12248 PURO	PMA-250C110	CH-12209 CYCL	QSA-1569	CH14-13356 OS	R-39392	CH05-11467 CASE
PCA563SY	SC-12270 CONTI	PM-1588	CH-12660 PURO	PMA-250C5S	CH-12209 CYCL	QSA-1569-SY	SC14-13357 OS	R-39393	ST-13410 CASE
PCA6526	CH-12249 CONTI	PM-1605	CH-12386 PURO	PMA-316HD	CH-12206 CYCL	QSA-1581	CH-12268 OS	R-517	CH-12235 ROMA
PCA7087	PF-15683 CONTI	PM-1621	CH-12234 PURO	PMA-46976	CH-14104 CYCL	QSA-216	CH-12207 OS	R-517S	ST-13529 ROMA
PE-6169	CH-12215 PMC	PM-1623	CH-16873 PURO	PMA-4M8047	CH-12208 CYCL	QSA-224	CH-12208 OS	R-5386	CH-12283 ROMA
PEA-526	CH-12653 PURO	PM-1627	CH-12980 PURO	PMA-4M8048	CH-13157 CYCL	QSA-226	CH-12214 OS	R-637	CH14-12245 ROMA
PEA-537	CH-12215 PURO	PM-1628	CH-12232 PURO	PMA-4M9334	CH-12214 CYCL	QSA-226-SY	CH-13141 OS	R-637-S	SC14-12254 ROMA

Number Finder



MFRS. NO.	OUR NO. MFR	MFRS. NO.	OUR NO. MFR	MFRS. NO.	OUR NO. MFR	MFRS. NO.	OUR NO. MFR	MFRS. NO.	OUR NO. MFR
R-641	CH-12209 ROMA	RT600501111	ST08-14413 JDEER	SA-430	SC10-11317 WGB	SE120	ST-13531 KNCT	SMP77-1527	CH-13477 DON
R-6460	CH-12980 ROMA	RTC3479	CH-12857 LEYL	SA-434	CH08-11288 WGB	SE150	ST-13527 KNCT	SMP77-1528	CH-12250 DON
R-650	CH-16873 ROMA	S010042783	CH08-11935 SEDEM	SA-435	CH-12282 WGB	SE210	ST-13529 KNCT	SMP77-1528	CH-16874 DON
R-797	CH-12386 ROMA	S08505-10	CH08-11288 PCLN	SA-448	CH09-12244 WGB	SE280	ST-13528 KNCT	SMP77-1529	CH08-11942 DON
R80-0969	SC14-12254 DON	S-113979	CH05-11467 CASE	SA-449	ST09-12265 WGB	SKS-41373	CH05-11106 HYST	SMP77-1530	CH-12790 DON
R-804	CH-12231 ROMA	S-117745	CH09-12244 CASE	SA-469	CH06-11295 WGB	SKS-41373-2	CH05-11106 HYST	SMP77-1531	CH-12345 DON
R80-4200	CH-12798 DON	S-117746	ST09-12265 CASE	SA-79	CH-12262 WGB	SMP18-1007	CH-12268 DON	SMP77-1532	SC10-11317 DON
R80-4201	CH14-12245 DON	S-221106	CH10-12224 CASE	SA-919	CH-14387 SAVAR	SMP18-1033	CH-12262 DON	SMP77-1534	CH-14104 DON
R80-4300	CH12-11389 DON	S-221313	CH12-12251 CASE	SA-97-A	CH12-12251 WGB	SMP18-1034	CH12-11389 DON	SMP77-1537	CH-12653 DON
R80-4301	CH14-13356 DON	S-224637	CH-12266 CASE	SAF-300	PF-15684 STP	SMP18-1035	CH12-12251 DON	SMP77-1545	CH10-11308 DON
R80-4523	ST-14343 DON	S-231996	CH12-11389 CASE	SAF-602	PF-15683 STP	SMP18-1036	CH-12260 DON	SMP77-1549	CH06-11880 DON
R80-4523	ST06-11109 DON	S-236468	CH05-11467 CASE	S-AJ502	CH-12385 SHLU	SMP18-1041	CH-12273 DON	SMP77-1550	CH08-11935 DON
R80-4570	ST09-12265 DON	S7356A	CH08-14410 SOFM	SBA31453036	CH04-11675 FORD	SMP18-1042	CH18-17230 DON	SMP77-1551	CH-12660 DON
R-8047	CH-12208 ROMA	SA-100	CH05-11106 WGB	SBA31453107	CH05-11106 FORD	SMP18-1044	CH-12269 DON	SMP77-1552	CH-13074 DON
R-8047-S	CH-13157 ROMA	SA-100-A	CH05-11106 WGB	SBG-12-0005	CH-12262 DONH	SMP18-1046	CH14-12245 DON	SMP77-1553	CH-13270 DON
R-9045	CH-12210 ROMA	SA-107	CH-12262 WGB	SBG-12-0017	CH-12262 DONH	SMP18-1050	CH05-11106 DON	SMP77-1555	CH10-12390 DON
R-918	CH05-11106 ROMA	SA-109	CH-12262 WGB	SBG-12-0022	CH-12262 DONH	SMP18-1059	CH08-11288 DON	SMP77-1555	CH10-14455 DON
R-930-S	ST-16488 ROMA	SA-110	CH-13157 WGB	SBG-12-0032	CH-12262 DONH	SMP18-1062	CH06-14733 DON	SMP77-1562	CH-12275 DON
R-940-S	ST-13531 ROMA	SA-112	CH-12260 WGB	SBG-12-0035	CH-12262 DONH	SMP18-1063	CH09-12244 DON	SMP77-1563	CH-12247 DON
R-941	CH-12232 ROMA	SA-113	CH-12214 WGB	SBG-12-0250	CH-12262 DONH	SMP18-1064	CH10-11308 DON	SMP77-1564	CH-12385 DON
R-9601-S	ST-13527 ROMA	SA-128	CH-12208 WGB	SBG-12-0251	CH-12262 DONH	SMP18-1072	CH05-11467 DON	SMP77-1572	CH-13404 DON
RDK6220	SC14-12254 LEYL	SA-130	CH-13156 WGB	SBG-12-0252	CH-12262 DONH	SMP18-1088	CH-12386 DON	SMP77-1594	CH-12091 DON
RE-33884	CH08-11942 JDEER	SA-131	CH-12207 WGB	SBG-12-0253	CH-12262 DONH	SMP18-1089	CH-12231 DON	SMP77-3521	CH-12282 DON
RE35522	ST06-12048 JDEER	SA-133	CH-12210 WGB	SBG-12-0257	CH-12262 DONH	SMP18-1090	CH-12276 DON	SRG-20-0031	SC21-17075 DONH
RE-35523	CH-13074 JDEER	SA-134	CH-13150 WGB	SBG-12-0258	CH-12262 DONH	SMP18-1092	CH-12286 DON	STG-14-0338	CH-12273 DONH
RE42725	CH-12345 JDEER	SA-146	CH-12209 WGB	SBG-12-0259	CH-12262 DONH	SMP18-1102	CH-12210 DON	STRCOUH-37E	CH08-12243 SHRM
RE-42725	CH-12345 JDEER	SA-15	PF-14090 WGB	SBG-16-0024	CH-12260 DONH	SMP18-1103	CH-12208 DON	SW621074301	CH-12260 AVBA
RE-45827	CH08-12228 JDEER	SA-15	PFM-14095 WGB	SBG-16-0031	CH-12260 DONH	SMP18-1104	CH-12214 DON	SW621456A 3I	CH21-17070 AVBA
RE-45828	ST08-12229 JDEER	SA-188	CH-12262 WGB	SBG-16-0035	CH-12260 DONH	SMP18-1105	CH-12207 DON	SW621456A 3I	SC21-17075 AVBA
RO-34083	CH05-11106 R-P	SA-194	CH-12262 WGB	SBG-16-0059	CH-12260 DONH	SMP18-1116	CH-12260 DON	SX50-06	CH06-11295 BOSST
RS 3544	CH08-17365 BALD	SA-209	CH-11348 WGB	SBG-16-0113	CH-12260 DONH	SMP18-1119	CH-12271 DON	T-10-0890	CH-12262 TR-A
RS3542	CH07-14074 BALD	SA-229	CH-12275 WGB	SBG-16-0121	CH-12260 DONH	SMP18-1126	CH-12403 DON	T-10-1237	CH12-12251 TR-A
RS3543	ST07-14270 BALD	SA-229-A	CH-12275 WGB	SBG-16-0124	CH-12260 DONH	SMP18-1137	CH-12235 DON	T-10-2090	CH-12260 TR-A
RS3544	CH08-17365 BALD	SA-243	CH-12260 WGB	SBG-16-0350	CH-12260 DONH	SMP18-1184	CH-12235 DON	T-10-3951	PF-15677 TR-A
RS3545	ST08-14413 BALD	SA-263	CH12-11389 WGB	SBG-16-0351	CH-12260 DONH	SMP18-1186	CH-11020 DON	T-10-5043	CH08-12221 TR-A
RS3546	CH05-14409 BALD	SA-270	SC14-12254 WGB	SBG-16-0354	CH-12260 DONH	SMP18-1206	CH-12091 DON	T-10-5368	CH08-11288 TR-A
RS3547	ST05-14402 BALD	SA-278	CH08-12221 WGB	SBG-16-0355	CH-12260 DONH	SMP77-1174	SC-15604 DON	T-10-6587	CH12-11389 TR-A
RS3702	CH06-16050 BALD	SA-283	CH14-12245 WGB	SBG-16-0359	CH-12260 DONH	SMP77-1504	CH-12276 DON	T-10-6769	CH14-12245 TR-A
RS3703	ST06-16054 BALD	SA-294	CH08-12243 WGB	SDG-12-0067	CH-12262 DONH	SMP77-1507	CH-16873 DON	T-10-6834	SC12-11391 TR-A
RS3714	CH-14900 BALD	SA-330	PF-15677 WGB	SDG-12-0110	CH-12262 DONH	SMP77-1508	CH-12242 DON	T-10-7672	CH14-12245 TR-A
RS3715	CH04-14412 BALD	SA-334	SC12-11391 WGB	SDG-12-0140	CH-12262 DONH	SMP77-1509	CH-12238 DON	T-10-8668	CH10-11308 TR-A
RS3724	CH-14896 BALD	SA-368	CH-12268 WGB	SDG-12-0150	CH-12262 DONH	SMP77-1510	CH-12246 DON	T-10-9085	SC-12274 TR-A
RS3726	CH-14902 BALD	SA-374	CH05-12222 WGB	SDG-12-0211	CH-12262 DONH	SMP77-1515	CH-12752 DON	T-11-4747	CH08-12221 TR-A
RS3727	CH-16523 BALD	SA-380	CH14-12245 WGB	SDG-12-0240	CH-12262 DONH	SMP77-1516	CH-12248 DON	T-115437	ST-14343 JDEER
RS3744	CH-16689 BALD	SA-387	CH-12177 WGB	SE045	ST-16488 KNCT	SMP771519	CH-12282 DON	T-11-7797	CH-12268 TR-A
RS3870	CH-16294 BALD	SA-418	CH10-11308 WGB	SE046	ST-16880 KNCT	SMP77-1520	CH-12794 DON	T-1286	CH-13156 TR-A
RS3871	SC-16301 BALD	SA-420	CH-14104 WGB	SE080	ST-13530 KNCT	SMP77-1521	CH-15300 DON	T-1287	CH-13150 TR-A
RS3885	ST10-15380 BALD	SA-422	CH08-11288 WGB	SE081	ST-16876 KNCT	SMP77-1522	CH-12798 DON	T-17064	CH-12262 TR-A
RT600501111	CH08-14410 JDEER	SA-423	ST08-11316 WGB	SE082	ST08-11316 KNCT	SMP77-1527	CH12-11343 DON	T19505-55	CH08-11935 PCLN

Number Finder



MFRS. NO.	OUR NO. MFR	MFRS. NO.	OUR NO. MFR	MFRS. NO.	OUR NO. MFR	MFRS. NO.	OUR NO. MFR	MFRS. NO.	OUR NO. MFR
T-236	CH-11348 LUCS	TA-7467	CH-14104 TR-A	UT-41251	CH08-12243 UTEQ	VPD7036	ST06-12048 VAPOR	W27-676	PF-15683 WP
T-402	CH-12216 LUCS	TAX-33N	CH09-12244 JOY	V02505-50	ST08-11316 PCLN	VPD7038	ST-16487 VAPOR	W-6L-4714	PF-15677 NW
T-40348	CH05-11106 CASE	TC-1020610-2	CH12-12251 HYST	V02505-81	ST08-11316 PCLN	VPD7039	ST-16488 VAPOR	W705	CH-12386 CHMPI
T-40348	CH05-11106 DAVEY	TC3181	CH06-12258 MLPT	V04504-43	CH-12276 PCLN	VPD7040	ST-13530 VAPOR	W706	CH-12285 CHMPI
T-40349	CH05-11106 CASE	TD-427F-43	CH08-12243 GRYM	V-250D253FS	CH-13141 UAC	VPD7045	CH08-11942 VAPOR	W711	CH-12231 CHMPI
T-46316	CH10-11308 JDEER	TDX-27493	CH05-11106 M-F	V-36474	CH04-11675 CASE	VPD7056	ST06-12048 VAPOR	WA-6622	CH-12262 WBCCO
T-46317	SC10-12395 JDEER	TI950555	CH08-11935 PCLN	V-37721	CH-12386 CASE	VPD7061	ST08-11316 VAPOR	WA-8537	CH-12215 NPON
T-46976	CH-14104 TR-A	TRA8273234	CH05-11467 M-F	VA-1697	PF-15684 GR7	VPD7062	ST08-11316 VAPOR	WGA100	CH-12214 WDGT
T-8047	CH-12208 TR-A	TRA8273235	ST-13410 CASEI	VA-3192	PF-15683 GR7	VPD7063	ST-12226 VAPOR	WGA1028S	ST-16938 WDGT
T-9045	CH-12210 TR-A	TRA8273235	ST-13410 M-F	VA-3465	PF-15684 GR7	VPD7069	CH-12386 VAPOR	WGA1029	CH-12093 WDGT
T-9334	CH-12214 TR-A	TRA8273267	CH06-14733 M-F	VA-40	PF-15683 VALV	VPD7073	ST08-12229 VAPOR	WGA1030K	CH10-12390 WDGT
T-966133	CH12-12251 HYST	TX56178	CH09-12244 PRKN	VA-54	PF-15684 VALV	VPD7074	CH08-12228 VAPOR	WGA1030K	CH10-14455 WDGT
TA-2324	CH-12260 WBCH	U0-0890	CH-12262 UAC	VA-69	PF-15684 VALV	VPD7075	CH-12385 VAPOR	WGA1032	PF-15686 WDGT
TA-46	PF-15683 TXCO	U0-1237	CH12-12251 UAC	VE1061	SC18-17232 KOMD	VPD7076	ST-13531 VAPOR	WGA1042	CH08-11942 WDGT
TA-7315	CH-12177 TR-A	U0-1275	CH05-11106 UAC	VE1062	CH18-17230 KOMD	VPD7078	SC10-11317 VAPOR	WGA1049K	CH-12345 WDGT
TA-7320	CH-12206 TR-A	U0-1760	CH06-11038 UAC	VF-1364	CH-12260 WBCH	VPD7079	CH-12091 VAPOR	WGA105	CH-12249 WDGT
TA-7356	CH-12847 TR-A	U0-2090	CH-12260 UAC	VF-160R	CH-11020 A-R	VPD7084	ST-16876 VAPOR	WGA1050S	ST06-12048 WDGT
TA-7364	CH-12208 TR-A	U0-2745	CH04-11675 UAC	VF-160R	CH-11020 VRTX	VPD7086	CH08-11288 VAPOR	WGA1054K	CH-13824 WDGT
TA-7365	CH-13157 TR-A	U04505-43	CH-12276 PCLN	VH-3179	CH-12260 WBCCO	VPD7087	CH06-12258 VAPOR	WGA1057	CH-15300 WDGT
TA-7366	CH-12214 TR-A	U0-5043	CH08-12221 UAC	VH-4812	CH-12260 WBCH	VPD7091	CH06-11941 VAPOR	WGA1060	CH-12825 WDGT
TA-7367	CH-13156 TR-A	U0-5054	CH-12275 UAC	VJ-0560	CH12-11389 WBCCO	VPD7093	CH-13185 VAPOR	WGA107	CH-12283 WDGT
TA-7368	CH-12207 TR-A	U0-6587	CH12-11389 UAC	VJ-0561	SC12-11391 WBCCO	VPD7097	CH-13270 VAPOR	WGA1070S	CH-12225 WDGT
TA-7374	CH-12210 TR-A	U0-6769	CH14-12245 UAC	VJ-1881	CH14-12245 WBCCO	VPD7100	CH-12653 VAPOR	WGA1072	CH-15565 WDGT
TA-7375	CH-13150 TR-A	U0-6775	SC14-12254 UAC	VJ-1882	CH12-11389 WBCCO	VPD7129	ST-13527 VAPOR	WGA1075K	CH06-11880 WDGT
TA-7378	CH-12262 TR-A	U0-6834	SC12-11391 UAC	VJ-1884	SC14-12254 WBCCO	VPD7150	CH12-11343 VAPOR	WGA1077S	ST05-14402 WDGT
TA-7383	CH12-12251 TR-A	U0-7868	CH08-11288 UAC	VJ-1885	SC12-11391 WBCCO	VPD7150	CH-13477 VAPOR	WGA1079	CH07-14074 WDGT
TA-7386B	CH08-12243 TR-A	U0-8668	CH10-11308 UAC	VJ-2325	SC-12274 WBCCO	VPD7152	CH-12790 VAPOR	WGA108	CH-12260 WDGT
TA-7387	CH05-11106 TR-A	U0-8674	SC10-11317 UAC	VJ-3024	CH-12260 WBCCO	VPD7157	CH-12980 VAPOR	WGA1080	CH08-14410 WDGT
TA-7387B	CH05-11106 TR-A	U0-8736	CH05-12222 UAC	VJ-5139	CH-12266 WBCCO	VPD7178	CH-12279 VAPOR	WGA1083S	CH-13520 WDGT
TA-7388	CH-12260 TR-A	U0-9085	SC-12274 UAC	VJ5175	CH21-17070 KOMD	VPD7233	CH06-14733 VAPOR	WGA1087	CH-12716 WDGT
TA-7392	CH04-11675 TR-A	U0-9155	CH-12266 UAC	VJ-5175	CH21-17070 WBCCO	VPM8006	PF-15688 VAPOR	WGA108E	CH-12260 WDGT
TA-7392B	CH04-11675 TR-A	U0-9200	CH-12269 UAC	VJ-5176	SC21-17075 WBCCO	VS-1956	CH10-11308 WBCCO	WGA1091S	ST06-12048 WDGT
TA-7399	PF-15677 TR-A	U1-3343	SC10-12395 UAC	VP-0357	CH12-11389 WBCCO	VS-1968	CH12-11389 WBCCO	WGA1093	CH-13763 WDGT
TA-7401	CH08-12221 TR-A	U1-3501	CH-14104 UAC	VP125395	CH05-14409 LNDI	VS-2317	SC-12270 WBCCO	WGA1094	CH-12790 WDGT
TA-7402	CH-12275 TR-A	U1-9370	SC-12274 UAC	VP-4365	CH12-11389 WBCH	VS-2318	CH-12269 WBCCO	WGA11	CH-12262 WDGT
TA-7402B	CH-12275 TR-A	U-44956	SC14-12254 JDEER	VP-4711	CH10-11308 WBCH	VS-2395	SC10-11317 WBCCO	WGA1109	CH06-16050 WDGT
TA-7404	CH08-11288 TR-A	U-44957	CH14-12245 JDEER	VP-4712	CH14-12245 WBCH	VS-630	CH-12260 WBCH	WGA111	CH-12242 WDGT
TA-7410	CH12-11389 TR-A	U4M-383	CH-12208 UAC	VP-7377	CH10-11308 WBCH	VS-6300	CH-12260 WBCH	WGA111S	ST-13527 WDGT
TA-7413	CH14-12245 TR-A	U4M-3976	CH-12207 UAC	VPD 7124	CH08-11288 VAPOR	VY-5281	CH14-12245 WBCH	WGA112	CH-12216 WDGT
TA-7414	SC14-12254 TR-A	U4M-8048	CH-13157 UAC	VPD 7141	CH-13075 VAPOR	VY-8537	CH-12273 WBCCO	WGA113	CH-12385 WDGT
TA-7415	CH05-11106 TR-A	U4M-9334	CH-12214 UAC	VPD7003	CH-12209 VAPOR	VY-8538	SC-12274 WBCCO	WGA113S	ST-13531 WDGT
TA-7417	SC-12274 TR-A	U4M-9335	CH-13156 UAC	VPD7012	CH-12867 VAPOR	VY-9209	CH14-12245 WBCCO	WGA114	CH-12386 WDGT
TA-7418	CH-12273 TR-A	U4M-9376	CH-12207 UAC	VPD7015	CH-12485 VAPOR	VY-9210	SC14-12254 WBCCO	WGA114S	ST-13530 WDGT
TA-7427	ST06-11315 TR-A	U7M-9045	CH-12210 UAC	VPD7016	CH-12491 VAPOR	W 04505-43	CH-12276 PPM	WGA1179	CH-15304 WDGT
TA-7437	CH-12268 TR-A	U7M-9046	CH-13150 UAC	VPD7022	CH-12209 VAPOR	W0350586	CH-12235 PCLN	WGA122	CH-12208 WDGT
TA-7445	CH-12209 TR-A	UD080300107	CH-12847 AIRM	VPD7026	CH06-11056 VAPOR	W04505-44	SC10-11317 PCLN	WGA125	CH-12397 WDGT
TA-7450	CH-12209 TR-A	UE5801	CH-12177 RR	VPD7029	CH-12275 VAPOR	W27-505-44	ST-13527 PCLN	WGA128	CH-12231 WDGT
TA-7454	CH-12262 TR-A	UE9813	CH-12177 RR	VPD7033	CH-12231 VAPOR	W27-587	PF-15684 WP	WGA128S	ST-16487 WDGT
TA-7457	CH-12262 TR-A	UT-37441	CH05-11106 UTEQ	VPD7034	CH-12386 VAPOR	W27-636	PF-15683 WP	WGA129K	CH10-11308 WDGT

Number Finder



MFRS. NO.	OUR NO. MFR	MFRS. NO.	OUR NO. MFR	MFRS. NO.	OUR NO. MFR	MFRS. NO.	OUR NO. MFR	MFRS. NO.	OUR NO. MFR					
WGA129KE	CH10-11308	WDGT	WGA307E	CH-12269	WDGT	WGA478K	CH05-11467	WDGT	XLP18-2036	CH-12260	DON	XLP77-4501	CH-15565	DON
WGA129S	SC10-11317	WDGT	WGA307S	SC-12270	WDGT	WGA478S	ST-13410	WDGT	XLP18-2039	CH-12266	DON	XLP77-4521	CH-12282	DON
WGA12KE	CH06-11038	WDGT	WGA309K	CH06-11295	WDGT	WGA486	CH-13185	WDGT	XLP18-2040	CH21-17070	DON	XLP77-4524	CH14-12245	DON
WGA12S	ST-14343	WDGT	WGA309KE	CH06-11295	WDGT	WGA494K	CH-12688	WDGT	XLP18-2041	CH-12273	DON	XLP77-4552	CH-15300	DON
WGA130	CH-12268	WDGT	WGA309S	ST06-11315	WDGT	WGA54E	CH16-12253	WDGT	XLP18-2042	CH18-17230	DON	XLP77-4576	CH-15294	DON
WGA131	CH-12826	WDGT	WGA30E	CH14-12245	WDGT	WGA599	CH-14104	WDGT	XLP18-2044	CH-12269	DON	Y 057 534 12	CH12-11389	PACAR
WGA133	CH-12980	WDGT	WGA30S	SC14-12254	WDGT	WGA605S	CH-12605	WDGT	XLP18-2045	CH10-12224	DON	Y 057 535 10	CH14-12245	PACAR
WGA135	PF-15680	WDGT	WGA312	CH-12212	WDGT	WGA670	CH-11020	WDGT	XLP18-2046	CH14-12245	DON	Y 057 542 09	CH16-12253	PACAR
WGA136	CH-12213	WDGT	WGA318	CH-12210	WDGT	WGA835	ST08-11110	WDGT	XLP18-2050	CH05-11106	DON	Y00704404	CH-12262	FDN
WGA13KE	CH10-12224	WDGT	WGA319	CH-12207	WDGT	WGA87	CH-12264	WDGT	XLP18-2052	CH06-11038	DON	Y02520504	CH12-11389	FDN
WGA142	CH-12206	WDGT	WGA325	CH-12278	WDGT	WGA878	PF-15684	WDGT	XLP18-2054	CH08-11003	DON	Y03547112	CH14-12245	FDN
WGA143	CH-11211	WDGT	WGA330	CH-12285	WDGT	WGA90	CH-12246	WDGT	XLP18-2062	CH06-14733	DON	Y05753412	CH12-11389	FDN
WGA144	CH-12289	WDGT	WGA331	CH-12225	WDGT	WGA91	CH-12236	WDGT	XLP18-2063	CH09-12244	DON	Y05753510	CH14-12245	FDN
WGA148	CH-12215	WDGT	WGA331S	ST-16876	WDGT	WGA921	CH-12953	WDGT	XLP18-2064	CH10-11308	DON	Y05754209	CH16-12253	FDN
WGA14K	CH12-12251	WDGT	WGA334	CH-12238	WDGT	WGA927	CH-12798	WDGT	XLP18-2072	CH05-11467	DON	Y1500001	ST06-12048	ECOM
WGA152	CH-12839	WDGT	WGA338K	CH08-12221	WDGT	WGA927S	SC10-12395	WDGT	XLP18-2090	CH-12276	DON	Y-531281	CH12-12251	WHITE
WGA155	CH-12209	WDGT	WGA338KE	CH08-12221	WDGT	WGA928	CH-13074	WDGT	XLP18-2092	CH-12286	DON	YM121120-125	CH05-11106	KOMD
WGA15K	CH05-11106	WDGT	WGA339KE	CH09-12244	WDGT	WGA96	CH-12235	WDGT	XLP18-4033	CH-12262	DON	YM171022-125	CH04-11675	KOMD
WGA15KE	CH05-11106	WDGT	WGA340KE	CH08-12228	WDGT	WGA964K	CH-13811	WDGT	XLP18-4034	CH12-11389	DON	YM171022-125	CH04-11675	KOMD
WGA160S	ST-16488	WDGT	WGA340S	ST08-12229	WDGT	WGA96S	ST-13529	WDGT	XLP18-4035	CH12-12251	DON	YMR000060	CH05-11106	FAIEX
WGA161K	CH06-12258	WDGT	WGA343	CH-13157	WDGT	WGA97	CH-12248	WDGT	XLP18-4036	CH-12260	DON	YMR000463	CH05-11106	FAIEX
WGA168	CH-12781	WDGT	WGA344	CH-13150	WDGT	WGA986	CH-14107	WDGT	XLP18-4041	CH-12273	DON	YMR000463	CH-14393	KMTS
WGA16KE	CH08-11003	WDGT	WGA345	CH-13156	WDGT	WGA987	CH-14104	WDGT	XLP18-4042	CH18-17230	DON	YYP101237	CH12-12251	KWSK
WGA16S	ST08-11110	WDGT	WGA355	CH-12091	WDGT	WGA989	CH-13090	WDGT	XLP18-4044	CH-12269	DON	YYP106587	CH12-11389	KWSK
WGA171K	CH05-12222	WDGT	WGA372K	CH-12275	WDGT	WGA991	CH-14334	WDGT	XLP18-4046	CH14-12245	DON	YYP106769	CH14-12245	KWSK
WGA178	CH-12752	WDGT	WGA376	CH-12271	WDGT	WGA993	CH-12857	WDGT	XLP77-2504	CH-12276	DON	YYP106775	SC14-12254	KWSK
WGA179	CH-12232	WDGT	WGA378K	CH04-11675	WDGT	WGA995	CH-12498	WDGT	XLP77-2519	CH-12282	DON	YYP106834	SC12-11391	KWSK
WGA18	CH12-11389	WDGT	WGA382K	CH06-11056	WDGT	WGA998	CH-13050	WDGT	XLP77-2520	CH-12794	DON	YYP108668	CH10-11308	KWSK
WGA183	CH-12247	WDGT	WGA382S	ST-12226	WDGT	WGS236	CH-13141	WDGT	XLP77-2521	CH-15300	DON	YYP108674	SC10-11317	KWSK
WGA189	CH08-11288	WDGT	WGA395	CH-13141	WDGT	X08505-38	CH-12266	PCLN	XLP77-2522	CH-12798	DON	YYP117431	CH12-12251	KWSK
WGA18E	CH12-11389	WDGT	WGA400	CH14-13356	WDGT	X08505-61	SC12-11391	PCLN	XLP77-2527	CH12-11343	DON	YYP117437	CH14-12245	KWSK
WGA18S	SC12-11391	WDGT	WGA400S	SC14-13357	WDGT	X-13692	CH12-12251	FORD	XLP77-2527	CH-13477	DON	YYP119373	SC14-12254	KWSK
WGA194	CH-12867	WDGT	WGA406	CH21-17070	WDGT	X-161-WA-653	CH12-12251	BLH	XLP77-2529	CH08-11942	DON	Z08505-62	CH12-11389	PCLN
WGA205	CH-12177	WDGT	WGA406S	SC21-17075	WDGT	X-2409001	CH05-11106	TRAN	XLP77-2530	CH-12790	DON	Z2950577	ST08-14413	CASEI
WGA206	CH-12234	WDGT	WGA412K	CH10-11308	WDGT	X-24090019	CH05-11106	TRAN	XLP77-2531	CH-12345	DON	Z76-01-18130	CH-12770	KOMD
WGA207E	CH-12266	WDGT	WGA434	PF-15677	WDGT	X-27780	PF-15677	WHITE	XLP77-2532	SC10-11317	DON	Z76-01-25830	CH-12716	KOMD
WGA21	CH-12653	WDGT	WGA439S	CH-12302	WDGT	X-3786-P-1706	CH-12262	SHRM	XLP77-2534	CH-14104	DON	Z760225550	ST-14343	KOMD
WGA22K	CH08-11288	WDGT	WGA440	CH-11211	WDGT	X-378-P-17064	CH-12262	SHRM	XLP77-2545	CH10-11308	DON	Z76-02-34750	CH07-14865	KOMD
WGA22S	ST08-11316	WDGT	WGA441	CH-12289	WDGT	X4326841	ST06-16054	HTCH	XLP77-2549	CH06-11880	DON	Z76-02-AF931	CH05-11106	KMTS
WGA26	CH-12250	WDGT	WGA442	CH-12283	WDGT	X-43-422	CH08-12243	LEROI	XLP77-2550	CH08-11935	DON	Z76-02-AF932	CH04-11675	HEDEN
WGA26	CH-16874	WDGT	WGA443	CH-12282	WDGT	X43-545	CH10-11308	WBCO	XLP77-2552	CH-13074	DON	ZPF35/6	CH-12839	LSTRP
WGA29	CH-12660	WDGT	WGA453K	CH06-11941	WDGT	X43-564	CH12-12251	WBCO	XLP77-2553	CH08-14835	DON			
WGA30	CH14-12245	WDGT	WGA454	CH-12809	WDGT	X-75497	CH-12266	HOUG	XLP77-2555	CH10-12390	DON			
WGA301	CH-12286	WDGT	WGA-462K	CH-13270	WDGT	X810270072	ST-16879	FNDT	XLP77-2555	CH10-14455	DON			
WGA301S	ST09-12265	WDGT	WGA466S	CH-12485	WDGT	XA-76507	CH05-11106	CASE	XLP77-2564	CH08-12228	DON			
WGA303	CH-12276	WDGT	WGA467K	CH08-11935	WDGT	XB-39303	CH05-11106	CASE	XLP77-2565	CH-13075	DON			
WGA304E	CH-12273	WDGT	WGA470S	ST-14787	WDGT	XD-91927	CH06-14733	CASE	XLP77-2586	CH-15565	DON			
WGA304S	SC-12274	WDGT	WGA477	CH18-17230	WDGT	XLP18-2002	CH16-12253	DON	XLP77-2587	CH-12345	DON			
WGA307	CH-12269	WDGT	WGA477S	SC18-17232	WDGT	XLP18-2034	CH12-11389	DON	XLP77-2597	CH-13473	DON			

Cross Reference by Manufacturer



MFRS. NO.	OUR NO.	MFRS. NO.	OUR NO.	MFRS. NO.	OUR NO.	MFRS. NO.	OUR NO.	MFRS. NO.	OUR NO.
AC		A297C	CH05-11106	A726C	CH-12268	PC-390	CH-12285	8020729	CH-13880
25096141	CH-12278	A297CL	CH05-11106	A727C	CH10-11308	PC-400	CH-12247	8023027	CH-14111
A1003C	CH-12278	A299CL	CH08-11003	A751C	PF-15684	PC-41	CH-11348	AIR ENERGIE	
A10062A	CH-12213	A29C	CH-12289	A846C	CH-12385	PC-411	ST08-11316	010965	CH05-11106
A10062R	CH-12213	A301CL	CH10-12224	A858C	PF-15683	PC-420	CH-12236	010966	CH04-11675
A1019C	CH-12283	A303C	CH-12209	A880C	PF-15677	PC-421	CH-12246	AIR MAZE	
A101C	ST08-11110	A408C	CH12-11389	A888C	ST-14343	PC-422	CH-12826	CD01625502830	CH-12867
A1023C	CH-12213	A417CL	CH-12273	A889C	CH09-12244	PC-437	CH-12264	CD0615502830	CH-12867
A1026C	CH-12204	A424C	SC-12274	A901C	CH21-17070	PC-445	CH-11211	CD0615506830	CH-12867
A1028C	CH-12248	A424CL	SC-12274	A902C	SC21-17075	PC-49	PF-15680	CD0615610-830	CH-12867
A1029C	CH-12386	A428C	CH14-12245	A910C	ST09-12265	PC-67	CH-12249	CD1221B05826	CH-12781
A1030C	CH-12235	A443C	SC14-12254	A953C	CH18-17230	PC-75	CH-12250	ED03013	ST08-12229
A1032C	CH-12653	A445C	CH-12269	A976C	CH-12234	PC-75	CH-16874	UD080300107	CH-12847
A1033C	CH-12397	A445CL	CH-12269	AF1072C	PF-14090	PC-88	CH12-11389	AIR REFRINER	
A1035C	CH-12242	A446C	SC-12270	AF1072C	PFM-14095	ACME MACHINERY		ARM-10-0890	CH-12262
A1036C	CH-12215	A456C	CH-12260	PC-10	CH-12209	6616	CH-12262	ARM-1009-2K	CH-12262
A1037C	CH-12216	A457C	CH05-12222	PC-125	CH-12249	ADVANCE MACHINE		ARM-10-1237	CH12-12251
A1038C	CH-12249	A457CL	CH05-12222	PC-134K	CH12-12251	2478463	CH04-11675	ARM-10-1275	CH05-11106
A1042C	CH-12231	A462C	SC12-11391	PC-135	CH14-12245	478463	CH04-11675	ARM-10-2090	CH-12260
A1043C	CH-12091	A462CL	SC12-11391	PC-138	CH05-11106	478720	CH05-11467	ARM-10-2745	CH04-11675
A1045C	CH08-12228	A475C	CH10-11308	PC-138K	CH05-11106	478722	ST-13410	ARM-10-5043	CH08-12221
A1056C	CH-12867	A475CL	CH10-11308	PC-139	CH-12653	AG CHEM EQUIPMENT		ARM-10-5054	CH-12275
A10578R	CH-12660	A476C	SC10-11317	PC-140	CH-12262	027407	CH16-12253	ARM-10-5368	CH08-11288
A1057C	ST-13410	A476CL	SC10-11317	PC-177	CH-12231	609374	SC12-11391	ARM-10-6587	CH12-11389
A1072C	PF-14090	A525C	CH-12275	PC-178	CH-12980	701165	CH10-11308	ARM-10-6769	CH14-12245
A1072C	PFM-14095	A527C	CH04-11675	PC-179	CH-12386	702455	CH14-12245	ARM-10-6775	SC14-12254
A1086C	CH-12247	A529C	CH08-11288	PC-181	CH-12212	702463	SC14-12254	ARM-10-6834	SC12-11391
A1089C	PF-15684	A549C	CH-14104	PC-183	CH-12385	720189	CH12-11389	ARM-10-8668	CH10-11308
A1117C	CH-12272	A550C	CH06-14733	PC-185	CH-12242	720257	CH08-11003	ARM-10-8674	SC10-11317
A1185C	CH-12403	A559C	CH08-12221	PC-186	CH-12248	720258	CH10-12224	ARM-10-8736	CH05-12222
A1533C	CH-12282	A574C	CH14-13356	PC-187	CH-12235	721012	SC-12252	ARM-10-9085	SC-12274
A1554C	ST06-12048	A575C	SC14-13357	PC-188	CH-12177	721237	CH12-11389	ARM-10-9200	CH-12269
A1565C	CH-12485	A587C	CH08-11288	PC-190	CH-12260	721237023A	CH12-11389	ARM-10-9206	SC-12270
A1581C	CH08-12228	A588C	ST08-11316	PC-196	CH-12397	AGRIFUL		ARM-11-0022	CH09-12244
A1592C	CH06-11941	A590C	CH-12268	PC-197	CH-12238	059901104	ST-12226	ARM-1113	CH-12214
A184C	CH-12262	A602C	CH-12847	PC-200	CH-12234	059905104	ST06-11315	ARM-1114-1S	CH-12403
A206C	CH-12262	A614C	CH05-11467	PC-212	CH-12091	730190101	CH06-11056	ARM-1116	CH-12210
A207C	CH-12208	A619C	ST-12226	PC-215	CH-12235	730190201	CH05-12222	ARM-1126	CH14-12245
A208C	CH-12210	A620C	CH06-11056	PC-217	CH-12177	730190601	CH06-11295	ARM-11-3341	CH10-11308
A209C	CH-12214	A631C	CH-12177	PC-299K	CH08-11288	AGRITALIA		ARM-11-3343	SC10-12395
A210C	CH-12207	A646C	CH-12209	PC-33	CH-12206	45401	CH-10677	ARM-11-4500	ST06-11315
A255C	CH-11211	A64C	CH-12232	PC-331	CH10-11308	45409	CH08-11003	ARM-11-4747	CH08-12221
A256C	CH-11020	A662C	CH-12282	PC-333	SC10-11317	45449	SC06-11269	ARM-1163	CH-12397
A260C	CH-12225	A670C	ST06-11315	PC-334	CH09-12244	45450	CH06-11255	ARM-11-7092	CH-12282
A265C	CH-12260	A671C	CH06-11295	PC-347	CH-12213	45452	SC08-11253	ARM-11-7580	CH-12273
A266C	CH-13156	A674C	CH08-11288	PC-360	PF-15684	45453	CH08-11003	ARM-11-7781	SC21-17075
A288C	CH-13150	A677C	CH-13141	PC-370	CH-12213	47210	PF-15888	ARM-11-7782	CH21-17070
A290C	CH-13157	A685C	SC10-12395	PC-378	CH-12247	47805	PF-15861	ARM-11-7797	CH-12268
A296C	CH12-12251	A702C	PF-15677	PC-389	CH-12225	AIFO		ARM-11-8211	CH14-13356

Cross Reference by Manufacturer



MFRS. NO.	OUR NO.	MFRS. NO.	OUR NO.	MFRS. NO.	OUR NO.	MFRS. NO.	OUR NO.	MFRS. NO.	OUR NO.
ARM-11-8216	SC14-13357	ARM-18-1046	CH14-12245	ARM-712	CH-13157	MD382	CH-12242	1007973	CH08-11288
ARM-11-9135	CH06-11295	ARM-18-1050	CH05-11106	ARM-713	CH-13156	MD388	CH-11211	1010407	CH08-11288
ARM-11-9136	CH08-11288	ARM-18-1059	CH08-11288	ARM-716	CH-13150	MD392	CH-12225	1014652	CH05-11467
ARM-11-9363	CH08-11288	ARM-18-1063	CH09-12244	ARM-722	CH-12271	MD410	PF-15680	107974	ST08-11316
ARM-11-9410	ST08-11316	ARM-18-1064	CH10-11308	ARM-806-K	CH10-11308	MD436	PF-15684	1140889	CH05-11106
ARM-11-9538	CH06-14733	ARM-18-1102	CH-12210	ARM-8094	CH-12491	MD478	CH-12264	1181296	ST09-12265
ARM-11-9612	CH10-11308	ARM-18-1104	CH-12214	ARM-8095	CH-12485	MD480	CH-12246	1183993	SC10-11317
ARM-11-9648	CH06-11056	ARM-18-1126	CH-12403	ARM-812	CH-12207	MD484	CH-16873	1909116	CH08-12228
ARM-11-9649	ST-12226	ARM-2052	CH-12385	ARM-8155	CH-12867	MD486	CH-12246	1909128	CH06-11056
ARM-11-9775	CH06-11038	ARM-2055	CH-12232	ARM-83121	CH-12215	MD488	CH-12980	1909129	ST-12226
ARM-11-9778	ST09-12265	ARM-2080	CH-12236	ARM-83122	CH-12216	MD492	CH-12091	1909136	CH12-11389
ARM-12-0022	CH09-12244	ARM-2301	CH-12242	ARM-911-K	CH12-12251	MD494	CH-12285	1909140	ST-12226
ARM-12-0281	CH05-11467	ARM-2302	CH-12248	ARM-912	CH-12208	MD498	CH-12231	1909141	CH06-11056
ARM-12-0307	ST-13410	ARM-2350	CH-12234	ARM-99-7064	CH-12225	MD512	CH-12273	2083768	SC12-11391
ARM-1204-A	CH-12249	ARM-2350/1	CH-12242	ARM-9972	CH-13141	MD514	SC-12274	2083771	CH12-11389
ARM-12-2492	CH08-12243	ARM-2400	CH-16873	ARP-15	PF-14090	MD520	CH-12248	2097035	CH05-11106
ARM-12-2510	CH05-11106	ARM-2401	CH-12235	ARP-15	PFM-14095	MD522K	CH05-12222	2097407	CH04-11675
ARM-12-3160	ST-14343	ARM-2407	CH-12238	ARP-188	CH-12206	MD524	CH-12213	237395	CH-12209
ARM-12-3412	PF-14090	ARM-260	CH-12491	ARP-190	CH-12206	ALFA ROMEO		257024	CH08-11288
ARM-12-3412	PFM-14095	ARM-261	CH-12485	ARP-192	CH-12177	701009/E	CH-12135	257029	ST08-11316
ARM-12-4164	CH08-12228	ARM-2706	CH-11211	ARP-2163	CH-11348	ALLIS-CHALMERS		266787	CH09-12244
ARM-12-4165	ST08-12229	ARM-2850	CH-12246	ARP-65	CH-12847	01902129	CH-12278	267953	ST09-12265
ARM-12-4445	CH06-11295	ARM-3001	CH-12264	VF-160R	CH-11020	02165054	CH-12242	30000440155	CH06-11295
ARM-12-4526	SC10-11317	ARM-3002	CH-12278	AKERMAN		02394637	ST-13529	3039681	CH12-12251
ARM-12-7532	CH-12276	ARM-307-K	CH04-11675	814774	CH-12213	0239513	CH05-11106	3042922	CH12-11389
ARM-12-7784	CH08-12228	ARM-320	CH-12272	ALASKA DIESEL		0239518	CH05-11106	3045860	CH12-12251
ARM-12-7787	ST08-12229	ARM-3322	CH-12247	600-181-9200	CH08-11288	0240760	CH04-11675	3047497	CH12-12251
ARM-12-8407	CH18-17230	ARM-347436	CH-12213	ALCO		0244570	SC12-11391	3047497-7	CH12-12251
ARM-12-8408	SC18-17232	ARM-410	CH05-11106	MD022	CH-12177	0250699	CH05-11106	3050258	CH12-11389
ARM-13-0502	CH-12286	ARM-410-K	CH05-11106	MD062	CH-12206	0256395	CH09-12244	3050899	CH12-12251
ARM-13-1394	ST08-11110	ARM-419-K	CH05-12222	MD116	CH-12209	0256983	CH08-11288	3051818	CH12-12251
ARM-13-4743	CH-12268	ARM-46976	CH-14104	MD124	CH-12212	0257597	CH05-11106	3067508	ST08-11316
ARM-13-7178	CH-12268	ARM-475386	CH-12283	MD152K	CH05-11106	0260309	CH08-11288	4055745	CH-11348
ARM-15-1276	ST-13530	ARM-475975	CH-12289	MD160	CH-12660	0267075	CH09-12244	4146001	CH-11348
ARM-15-3476	ST-13531	ARM-476769	CH-12213	MD200	CH-12250	0267931	SC10-11317	42480759	ST-13527
ARM-1553	CH-12231	ARM-492	CH-12209	MD200	CH-16874	0267962	SC10-11317	4357487	CH-12262
ARM-15-5676	ST-13527	ARM-505-K	CH06-14733	MD202	CH-12653	0654409	CH10-11308	4357688	CH-12262
ARM-1700	CH-12225	ARM-510	CH-12209	MD220K	CH12-12251	0658451	CH14-12245	4358792	CH-12262
ARM-17064	CH-12262	ARM-520	CH-12209	MD222	CH14-12245	0659533	CH14-12245	4386484	CH-12262
ARM-1740	CH-12091	ARM-52-2450	CH-12605	MD224	CH12-11389	0660360	CH12-11389	45480068	CH-11348
ARM-1750	CH-12980	ARM-6002	CH06-11941	MD230	CH-12385	0660360/9	CH12-11389	4789056	CH05-11106
ARM-1753	CH-12386	ARM-600-K	CH08-12221	MD234	CH-12238	0662477	SC14-12254	4841879	CH05-11106
ARM-1761	CH-12278	ARM-60619	CH-12283	MD238	CH-12235	0662607	CH16-12253	4900154	CH10-12224
ARM-18-1007	CH-12268	ARM-610-K	CH08-12221	MD260K	CH08-11288	0662608	SC10-11317	4907794	CH05-11106
ARM-18-1033	CH-12262	ARM-611	CH08-12243	MD292	CH-12262	0662609	SC12-11391	4996253	CH05-11106
ARM-18-1034	CH12-11389	ARM-616-K	CH08-11288	MD300	CH-12386	0667685	SC-12274	595601	CH-12215
ARM-18-1035	CH12-12251	ARM-6489T	CH-12212	MD320K	CH08-12221	0684732	CH10-11308	595602	CH-12215
ARM-18-1042	CH18-17230	ARM-711	CH-12275	MD352	CH-12210	0684733	CH12-11389	595603	CH-12216
ARM-18-1044	CH-12269	ARM-711-K	CH-12275	MD360	CH-12214	0684734	CH14-12245	595604	CH-12216

Cross Reference by Manufacturer



MFRS. NO.	OUR NO.	MFRS. NO.	OUR NO.	MFRS. NO.	OUR NO.	MFRS. NO.	OUR NO.	MFRS. NO.	OUR NO.
614103	CH14-13356	1254	CH06-11056	920	CH-12269	93811	CH-12206	94538	ST08-12229
614104	SC14-13357	1258	ST-14343	922	SC-12274	93868	CH08-11288	94541	CH-12242
648734	CH14-12245	1259	SC10-11317	93045	CH-12210	93878	CH-12249	94546	CH-12232
6626089	SC10-11317	1264	CH14-13356	93046	CH-13150	93890	CH-12262	94547	CH-12283
6626097	SC12-11391	1265	SC14-13357	93047	CH-12208	939	CH-14104	94554	CH-12385
662689/9	SC10-11317	1278	CH-12272	93048	CH-13157	93918	CH-14104	94560	ST09-12265
6676852	SC-12274	1296	PF-15684	93119	CH12-11389	93919	CH10-11308	94561	CH-12286
674967	CH-12273	1310	PF-15683	93123	CH05-12222	93920	SC10-11317	94569	ST08-14413
72097371	CH05-11106	1316	CH-12209	93133	PF-15684	93924	SC12-11391	94580	PF-14090
72257812	SC10-12395	1338	CH-12177	93142	CH08-11003	93927	CH-12269	94580	PFM-14095
9623788	CH14-12245	1386	CH-12282	93208	CH14-12245	93928	SC-12270	94594	CH-12234
99100307	CH-12225	1428	CH-12268	93209	SC14-12254	93966	CH-12268	94606	CH06-11295
ALUP		1443	CH-12206	93225	CH-12273	94120	PF-15683	94613	CH-13270
172.00329	CH-12397	1447	SC10-12395	93226	SC-12274	94133	PF-15684	94625	CH08-11942
172.07794	CH-14746	1498	CH08-11288	93237	CH12-12251	94188	CH-12206	94642	CH-12276
AMC		1547	ST08-11316	93238	CH21-17070	94210	CH-12847	94643	SC10-11317
958C	CH04-11675	1550	PF-14090	93239	SC21-17075	94263	ST05-14980	94652	CH07-14074
MA-4481	CH-14211	1550	PFM-14095	93258	CH18-17230	94270	CH04-11675	94741	CH-12278
AMERICAN HOIST		1564	PF-15684	93259	SC18-17232	94274	CH-12215	94852	CH-12289
0-2388-1	CH05-11106	1574	CH12-11389	93276	CH05-11106	94275	CH-12216	94868	CH-11020
526023	CH05-11106	1575	SC12-11391	93290	CH-12260	94294	CH-12091	976	CH05-11106
832046	CH14-12245	1581	CH18-17230	93321	CH08-11288	94313	CH-12397	981	CH08-12221
832047	SC14-12254	1582	SC18-17232	93334	CH-12214	94327	CH-12272	983	CH08-11288
834629	CH14-12245	1594	ST08-11110	93335	CH-13156	94328	CH-12247	985	CH-12275
834635	SC14-12254	1599	ST-13410	93336	CH-13141	94330	CH-12285	991	CH12-12251
834639	CH16-12253	1602	CH-12385	93342	CH-12272	94351	CH-12213	996	CH10-11308
834644	SC-12252	214	PF-14090	93378	CH-12207	94352	CH-12403	AP LOCKHEED	
A-221-1	CH05-11106	214	PFM-14095	93489	CH05-11467	94360	CH05-11106	AP-190	CH-12206
A-232-1	CH08-12243	278	CH-12262	93503	CH08-12221	94375	ST08-11110	AP-191	CH-12839
E-230115	CH08-12243	287	CH-12209	93505	CH-12209	94378	CH-12605	AP-192	CH-12177
E-380069	CH-12260	288	CH12-12251	93508	CH-12282	94407	ST-14715	AP-192A	CH-12177
M-27265-1	CH05-11106	294	CH-12208	93518	CH06-14733	94408	CH-12485	AP-3006K	CH-12268
AMERICAN PARTS		295	CH-13157	93522	CH09-12244	94414	CH-12248	AP-3007K	CH-12275
1012	CH05-12222	296	CH-12207	93540	CH-12275	94430	CH-12231	AP-3008	CH-13157
1028	ST-12226	298	CH-12214	93550	CH-12209	94466	CH08-12228	AP-3008A	CH-13157
1029	CH-12268	303	CH-13156	93595	PF-15677	94467	ST08-12229	AP-3027	SC14-12254
1033	PF-15677	304	CH-13150	93608	CH-12235	94487	CH08-12228	AP-3027A	SC14-12254
1084	CH-12249	305	CH-12210	93609	ST-13529	94496	CH-12716	AP-3028	CH-12266
1089	CH-12260	320	CH05-11106	93618	CH-12268	94498	CH-12491	AP-3029	CH05-12222
1093	CH14-12245	340	CH08-12221	93630	CH-12177	94502	CH-14722	AP-3032	CH05-12222
1134	CH-12262	341	CH-12275	93631	CH06-11056	94504	CH-14334	AP-3032K	CH05-12222
1149	SC21-17075	352	CH04-11675	93632	ST-12226	94510	CH-12225	AP-3035A	CH-12268
1150	CH21-17070	402	SC12-11391	93653	CH06-12258	94515	CH-12386	AP-3036	CH-12208
1153	CH-13141	403	CH12-11389	93656	CH14-13356	94517	ST-13410	AP-3036A	CH-12208
1169	CH05-11467	404	CH14-12245	93657	SC14-13357	94522	ST08-11316	AP-3039A	CH-12262
1170	CH06-14733	405	SC14-12254	93679	ST06-11315	94525	ST-13531	AP-3152	CH-12249
1209	CH09-12244	431	CH10-11308	93710	CH-12839	94526	CH06-11941	AP-3164	CH-12215
1210	ST09-12265	432	SC10-12395	93764	CH-12262	94532	ST-13530	AP-3164A	CH-12215
1212	ST06-11315	919	SC-12270	93769	ST-14343	94537	CH08-12228	AP-3165A	CH-12216

Cross Reference by Manufacturer



MFRS. NO.	OUR NO.	MFRS. NO.	OUR NO.	MFRS. NO.	OUR NO.	MFRS. NO.	OUR NO.	MFRS. NO.	OUR NO.
AP-3290	CH-12953	AP-3518	CH-12273	AP-839	CH-12235	LK-3422	CH05-11106	LK-848	CH-12262
AP-3290A	CH-12953	AP-3518A	CH-12273	AP-839A	CH-12235	LK-3446	CH-12231	LK-850	CH12-12251
AP-3309	ST08-11316	AP-3519	SC-12274	AP-846	CH-12250	LK-3451	CH-11211	LK-852	CH-12260
AP-3323	CH-12242	AP-3519A	SC-12274	AP-846	CH-16874	LK-3452	CH-12264	LK-855	CH-12248
AP-3323A	CH-12242	AP-3521	SC21-17075	AP-846A	CH-12250	LK-3454	CH-12213	LK-860	CH08-11288
AP-3331	CH-12386	AP-3521A	SC21-17075	AP-846A	CH-16874	LK-3457	CH-12289	LK-920	PF-15680
AP-3331A	CH-12386	AP-3522	CH10-11308	AP-848	CH-12262	LK-3486	CH-12752	LK-925	CH05-12222
AP-3335	CH-12660	AP-3522A	CH10-11308	AP-848A	CH-12262	LK-3497	CH04-11675	APCO	
AP-3335A	CH-12660	AP-3523	SC10-11317	AP-850K	CH12-12251	LK-3502	CH-12275	AA-163	PF-14090
AP-3336	CH-12232	AP-3523A	SC10-11317	AP-852A	CH-12260	LK-3504	SC12-11391	AA-163	PFM-14095
AP-3336A	CH-12232	AP-3524	CH09-12244	AP-855	CH-12248	LK-3507	SC14-12254	ARROW MANUFACTUR	
AP-3342	PF-15684	AP-3524A	CH09-12244	AP-855A	CH-12248	LK-3510	CH06-11295	4001363	CH08-12243
AP-3345	CH-12246	AP-3526	CH-12286	AP-856A	CH08-12243	LK-3511	ST06-11315	ASAHI	
AP-3347	CH-12385	AP-3526A	CH-12286	AP-860	CH08-11288	LK-3516	CH-12269	IA-378	CH04-11675
AP-3347A	CH-12385	AP-3527	ST09-12265	AP-860K	CH08-11288	LK-3517	SC-12270	MA-463	CH10-12224
AP-3350	CH-12247	AP-3527A	ST09-12265	AP-923A	CH-12397	LK-3518	CH-12273	MA-464	CH10-11308
AP-3350A	CH-12247	AP-3528	CH-12276	AP-924K	CH08-12228	LK-3519	SC-12274	MA-583	CH-12215
AP-3351	CH-12236	AP-3528A	CH-12276	AP-925	CH05-12222	LK-3520	CH21-17070	ASTON-MARTIN	
AP-3351A	CH-12236	AP-3529	SC10-11317	APH-3397A	CH-12091	LK-3521	SC21-17075	4808801	CH-12177
AP-3354A	CH08-11288	AP-3529A	SC10-11317	APP-190A	CH-12206	LK-3522	CH10-11308	ASTRA	
AP-3422	CH05-11106	AP-3530	CH06-11056	APP-191A	CH-12839	LK-3523	SC10-11317	023881A	CH05-11106
AP-3422K	CH05-11106	AP-3530A	CH06-11056	APP-3132A	CH-11348	LK-3524	CH09-12244	104147	SC14-12254
AP-3446	CH-12231	AP-3531	ST-12226	APP-3152A	CH-12249	LK-3527	ST09-12265	104412	SC-12274
AP-3446A	CH-12231	AP-3531A	ST-12226	APP-3342A	PF-15684	LK-3528	CH-13050	111340	CH-15673
AP-3451	CH-11211	AP-3532	CH08-12228	APP-3345A	CH-12246	LK-3529	SC10-11317	111341	SC-15681
AP-3451A	CH-11211	AP-3532A	CH08-12228	APP-744A	CH-12660	LK-3530	CH06-11056	119925	CH-16294
AP-3452	CH-12264	AP-3533	ST08-12229	APP-764A	CH-12212	LK-3531	ST-12226	119926	SC-16301
AP-3452A	CH-12264	AP-3533A	ST08-12229	LK-191	CH-12839	LK-3532	CH08-12228	21685	CH-12269
AP-3454	CH-12213	AP-3550	CH06-12258	LK-192	CH-12177	LK-3533	ST08-12229	21686	SC-12270
AP-3454A	CH-12213	AP-3635	CH-12781	LK-3008	CH-13157	LK-3550	CH06-12258	21886	CH14-12245
AP-3457	CH-12289	AP-3658	ST-16487	LK-3027	SC14-12254	LK-3635	CH-12781	28442	CH10-11308
AP-3486	CH-12752	AP-3659	ST-13530	LK-3028	CH-12266	LK-3658	ST-16487	30257	CH12-11389
AP-3486A	CH-12752	AP-3660	ST-13531	LK-3029	CH05-12222	LK-3659	ST-13530	45474	CH-12266
AP-3497	CH04-11675	AP-3661	ST-13527	LK-3032	CH05-12222	LK-3660	ST-13531	P-47629	CH08-12243
AP-3497A	CH04-11675	AP-3662	ST-13529	LK-3036	CH-12208	LK-3661	ST-13527	P-49360	CH08-12243
AP-3502	CH-12275	AP-500	CH-12177	LK-3152	CH-12249	LK-3662	ST-13529	P-81571	CH05-11106
AP-3502A	CH-12275	AP-500A	CH-12177	LK-3164	CH-12215	LK-3682	CH-12283	P-82301	CH05-11106
AP-3504	SC12-11391	AP-651	CH-12209	LK-3165	CH-12216	LK-3719	CH-13050	P-85059	CH09-12244
AP-3504A	SC12-11391	AP-651A	CH-12209	LK-3290	CH-12953	LK-3740	CH-12857	ATHEY	
AP-3507	SC14-12254	AP-700	CH12-11389	LK-3309	ST08-11316	LK-3748	CH-12867	P85148	ST-13410
AP-3507A	SC14-12254	AP-700A	CH12-11389	LK-3323	CH-12242	LK-500	CH-12177	P85149	CH05-11467
AP-3510	CH06-11295	AP-706A	CH-12660	LK-3331	CH-12386	LK-651	CH-12209	P85842	CH12-11389
AP-3510A	CH06-11295	AP-712	CH-12213	LK-3335	CH-12660	LK-700	CH12-11389	P85843	SC12-11391
AP-3511	ST06-11315	AP-712A	CH-12213	LK-3336	CH-12232	LK-712	CH-12213	ATLAS	
AP-3511A	ST06-11315	AP-713	CH-12653	LK-3342	PF-15684	LK-713	CH-12653	291 1788	CH05-14409
AP-3516	CH-12269	AP-713A	CH-12653	LK-3345	CH-12246	LK-795	CH14-12245	298 1113	CH08-14410
AP-3516A	CH-12269	AP-744	CH-12660	LK-3347	CH-12385	LK-839	CH-12235	2981124	ST08-14413
AP-3517	SC-12270	AP-795	CH14-12245	LK-3350	CH-12247	LK-846	CH-12250	2991546	CH07-14074
AP-3517A	SC-12270	AP-795A	CH14-12245	LK-3351	CH-12236	LK-846	CH-16874	869065	CH12-11389

Cross Reference by Manufacturer



MFRS. NO.	OUR NO.	MFRS. NO.	OUR NO.	MFRS. NO.	OUR NO.	MFRS. NO.	OUR NO.	MFRS. NO.	OUR NO.
869076	SC12-11391	3216 7080 01	CH08-11942	ABP30018962	CH-12209	PA-1646-FN	CH12-12251	PA-2381	ST-12226
A-60	PF-15684	3216 7082 02	SC10-12395	ABP3003085	CH05-11106	PA-1647	CH-13157	PA-2398	CH-12282
A-68	PF-15683	3216-5237-00	CH08-11935	GDO621001	CH05-11106	PA-1649	CH-12260	PA-2405	CH-12385
ATLAS COPCO		3216-5238 00	ST08-11316	MG621100301	CH-12269	PA-1649-OPC	CH-12260	PA-2413	CH-12272
1030-0659	CH-12249	3222-1881-91	CH-16294	MG621100302	SC-12270	PA-1669	CH-12210	PA-2416	CH-12386
1030-0832	CH-12249	5412-2915-00	CH08-11288	MT621024302	SC10-11317	PA-1670	CH-13150	PA-2418-FN	CH08-11288
1030-1070	CH-12249	5415-2915-00	CH08-11288	PG621523301	CH14-12245	PA-1673	CH-12207	PA-2419	ST08-11316
1613 8720 00	CH-17542	5415-2915-00	CH08-11288	PG621523302	SC14-12254	PA-1675	CH-13156	PA-2420	CH08-11288
1613 9001 00	CH-17541	5415-2916-00	ST08-11316	SW621074301	CH-12260	PA-1683	CH-12209	PA-2422	CH-12091
1619-1296	CH-12262	9706-1483	CH-12839	SW621456A 301	CH21-17070	PA-1690-FN	CH05-11106	PA-2423	CH-12225
1619-1613	CH-12212	ATLAS WEYHAUSEN		SW621456A 302	SC21-17075	PA-1718	CH-12206	PA-2426-FN	CH09-12244
1619-1879	CH12-12251	1318209	CH05-11106	AWD		PA-1719	CH-12177	PA-2427	ST09-12265
1619-2796	CH-12231	2601863	CH-12235	91112964	CH-13090	PA-1753-FN	CH08-12221	PA-2453	CH21-17070
1619-2797	CH-12386	2601874	ST-13529	BADGER		PA-1765	PF-15677	PA-2454	SC21-17075
1619-2798	CH-12242	423841	CH09-12244	7610-9223	CH14-12245	PA-1794-FN	CH-12275	PA-2474	CH-12242
1619-2798-00	CH-12242	424580	CH09-12244	9120014	CH04-11675	PA-1822-FN	CH08-11288	PA-2475	CH-12235
1619-2799	CH-12235	431181	ST09-12265	BAKER		PA-1865-FN	CH04-11675	PA-2489	ST-14343
1619-2799 00	CH-12235	451867	CH-12276	1-39439-5-1	CH05-11106	PA-1865N	CH04-11675	PA-2541-FN	CH06-11295
1619-2847	CH-12385	458455	CH08-11288	9033-AX1	CH08-12243	PA-1868	CH-12212	PA-2554	PF-14090
1619-2847 00	CH-12385	463009	ST08-11316	9033-AY1	CH05-11106	PA-1878	CH-12403	PA-2554	PFM-14095
1619-2867	CH-12397	466535	CH10-11308	BALDWIN		PA-1884	CH12-11389	PA-2562	CH18-17230
1619-2997	CH-12386	466546	SC10-11317	LL1615	CH-12208	PA-1885	CH14-12245	PA-2563	SC18-17232
1619-3711	CH-12268	848924	CH06-11056	LL1634	CH-12214	PA-1886	CH-12273	PA-2570	ST08-11110
1619-5327-00	ST-13531	ATSA		LL1636-FN	CH10-12224	PA-1889	CH-12847	PA-2588	CH-12867
1619-5441	ST-16487	ATA3559	PF-15683	LL1646-FN	CH12-12251	PA-1893	SC14-12254	PA-2602	ST-13410
1619-5545-00	ST-13527	AUTOPAR		LL1649	CH-12260	PA-1895	CH-12269	PA-2608	CH-11020
1619-5698	ST-13529	AC203	PF-15683	LL1667-FN	CH06-11038	PA-1902-FN	CH10-11308	PA-2641	CH-12276
1619-5698-00	ST-13529	AC214	PF-15684	LL1669	CH-12210	PA-1904	SC-12274	PA-2645	CH-14334
1619-5699	ST-13528	AC235	PF-15684	LL1681-FN	CH08-11003	PA-1906	SC-12270	PA-2649	CH-12289
1619-5699-00	ST-13528	AVCO		LL1690-FN	CH05-11106	PA-1907-FN	CH05-12222	PA-2653	CH-12403
203946	CH-12249	292737	CH05-11106	LL1846	CH16-12253	PA-1911	SC12-11391	PA-2664	CH-12604
2900 0593 00	CH-12285	703112	CH08-12243	LL1884	CH12-11389	PA-1912	SC10-11317	PA-2665	CH-12605
2900 5348 00	CH08-11288	AVELING-BARFORD		LL1885	CH14-12245	PA-1919	SC10-11317	PA-2669-FN	CH08-12228
2900 6488 00	CH05-11106	2811070	CH05-11106	LL1886	CH-12273	PA-1940	CH-14104	PA-2670	ST08-12229
2900-0206	CH-12278	318244/2	CH10-12224	LL1894	CH-12266	PA-1981	SC10-12395	PA-2707	CH-12283
2900-0501 00	ST-13527	506357	ST08-11110	LL1895	CH-12269	PA-2001	CH-12206	PA-2727	CH-12491
2900052500	ST-13529	726988	CH-12262	LL1902-FN	CH10-11308	PA-2103	PF-15684	PA-2728	CH-12485
2914 5005 00	SC10-11317	9007585	ST08-12229	LL1926	CH-12271	PA-2104	PF-15683	PA2757	CH-11211
2914 5017 00	CH-16971	9007611	ST08-12229	LL2344-FN	CH05-11467	PA2222	PF-15856	PA2764	CH-12653
2914 5018 00	ST-16972	9007613	CH08-12228	LL2360-FN	CH06-14733	PA-2310	CH-13141	PA-2765	CH-12397
2914 5044 00	CH10-11308	9007690	CH10-11308	LL2426FN	CH09-12244	PA-2312	CH-12268	PA-2767	CH-12231
2914.5000.00	CH14-12245	9007691	SC10-11317	LL2453	CH21-17070	PA-2331	CH-12209	PA-2768-FN	CH08-12228
2914.5004.00	CH10-11308	ABP3001558	SC-12274	LL2562	CH18-17230	PA-2332	ST06-11315	PA-2769	ST08-12229
2914-5010-00	CH-16294	ABP3001559	SC18-17232	LL2608	CH-11020	PA-2337	CH-12249	PA2770	PF-15680
3216 2614 00	SC12-11391	ABP3001560	CH18-17230	LL2641	CH-12276	PA-2344-FN	CH05-11467	PA-2772	CH-12285
3216 2771 00	CH-12269	ABP3001562	CH-12209	LL2783	CH-12286	PA-2345	CH14-13356	PA2773	CH-12302
3216 2772 00	SC10-11317	ABP3001567	CH-12867	PA-1621-2-OPC	CH-12262	PA-2346	SC14-13357	PA-2776	CH-12278
3216 3286 00	CH14-12245	ABP3001571	ST08-11110	PA-1621-OPC	CH-12262	PA-2360-FN	CH06-14733	PA-2783	CH-12286
3216 3287 00	SC14-12254	ABP3001572	CH-12273	PA-1634	CH-12214	PA-2380-FN	CH06-11056	PA-2790-FN	CH06-11941

Cross Reference by Manufacturer



MFRS. NO.	OUR NO.	MFRS. NO.	OUR NO.	MFRS. NO.	OUR NO.	MFRS. NO.	OUR NO.	MFRS. NO.	OUR NO.
PA-2801	CH-12264	PA3686	ST-16487	BARBER GREEN		1849125	CH09-12244	BOBCAT	
PA2808	CH-12781	PA3687	ST-16488	16F94	CH08-11288	1849126	ST09-12265	6598222	ST05-14980
PA-2810	CH-13050	PA3688	CH-15300	BARKO HOUSINGS		1849438	CH08-11935	6598362	ST06-11109
PA-2812	CH-12246	PA3690	CH08-11942	535-00316	CH10-12224	BENFRA		6646494	CH05-11106
PA-2813	CH-12387	PA3698	CH-12271	535-00422	CH10-12224	005-2222	CH06-11038	6666333	CH06-16050
PA-2814	ST-13529	PA3699	CH-15294	535-01025	CH06-14733	005-2223	ST06-11109	6666334	ST06-16054
PA-2833	CH-15565	PA3752	CH-12980	BAUER		10476	CH-12794	6671969	ST08-11110
PA-2834	SC-15604	PA3752	CH-11789	N01371	CH12-12251	10479	CH-12794	6672467	CH05-15887
PA2835	ST-13531	PA3753	CH-12980	N02206	CH05-11106	1849133	CH-12798	BOGE	
PA2836	ST-13527	PA3754	CH-13763	N07698	CH08-11288	40199	CH-12345	569000901	CH-17512
PA2837	ST-13530	PA3772	CH-12093	N08109	CH09-12244	54957	ST06-12048	BOMAG	
PA2838	CH-12247	PA3779FN	CH08-12228	N08152	CH06-11295	8322160	CH10-11308	05730102	CH10-12224
PA2845	CH-12386	PA3787	ST-17470	N08176	CH12-11389	8322161	SC10-11317	05730105	SC12-11391
PA2862	CH-12953	PA3807	CH-12236	N08177	SC12-11391	BERNARD		05730106	CH09-12244
PA2866	CH-12232	PA3808-FN	CH-13473	N08463	CH14-12245	023408	CH06-11295	05730110	CH08-11288
PA2869	CH-12213	PA3839	PF-15441	N08464	SC14-12254	023409	ST06-11315	05730112	ST08-11316
PA2888	CH-12809	PA3842	PF-15690	N08466	ST09-12265	023411	CH08-11288	05730113	SC-12274
PA2891	CH-12248	PA3843	PF-15693	N08567	CH10-11308	023412	ST08-11316	05730114	CH12-11389
PA2911	CH-12231	PA3848FN	CH-13811	N08568	SC10-11317	023414	CH09-12244	05730115	SC-12274
PA2912	CH-12870	PA3849	CH-12790	N10119	ST08-11316	023415	ST09-12265	05730116	CH12-12251
PA2917	CH-16873	PA3850	CH12-11343	BEDFORD		BITELLI		05730119	CH14-12245
PA2964	CH-12225	PA3850	CH-13477	91107151	CH-12857	265004	CH-12386	05730120	SC14-12254
PA2976FN	CH06-11880	PA3854FN	CH10-12390	91112964	CH-13090	265005	ST-13530	05730130	ST06-12048
PA2977-FN	CH-13270	PA3854FN	CH10-14455	BELL		BLACKWELDERS		05821012	CH-12385
PA2978	CH-12206	PA3855FN	CH-12345	200276	ST08-11316	042-1-03	CH05-11106	05821013	CH-12386
PA3405	CH-12857	PA3859	CH-13075	200277	CH08-11288	042-1-0370	CH05-11106	05821014	ST-13531
PA3414	PF-15686	PA3860	CH-12794	200443	CH14-12245	042-1-37	CH05-11106	05821015	ST-13530
PA3427	CH-12660	PA3866	ST06-11109	200444	SC14-12254	042-1-371	CH05-11106	05821018	CH-12242
PA3428	CH08-11935	PA4082	CH-12272	200451	ST09-12265	205-18-240	CH08-11288	058211019	ST-13527
PA3437	CH-13811	PA-608	PF-14090	200452	CH09-12244	205-19-240	ST08-11316	05821301	CH-12285
PA3476	CH-12716	PA-608	PFM-14095	200467	SC12-11391	2307428	CH08-12243	53521226	CH08-11288
PA3477	CH-16873	RS 3544	CH08-17365	200468	CH14-12245	BLAW-KNOX		BOMBARDIER	
PA3491	CH-14722	RS3542	CH07-14074	220132	CH18-17230	00164-757-01	CH09-12244	114113900	CH12-12251
PA3492	ST-14715	RS3543	ST07-14270	220133	SC18-17232	BLH		BONSER	
PA3494	ST-13528	RS3544	CH08-17365	220947	CH12-11389	X-161-WA-653	CH12-12251	046003	CH06-12258
PA3558	CH-15304	RS3545	ST08-14413	BENATI		BLOUNT		BOSCH	
PA3566	CH-12507	RS3546	CH05-14409	1849104	CH10-11308	525665	CH14-12245	0001A	CH-12385
PA3572	CH-12238	RS3547	ST05-14402	1849105	SC10-11317	537986	CH08-11003	0003A	CH12-11389
PA3593	CH-12387	RS3702	CH06-16050	1849106	CH14-12245	537987	ST08-11110	0004A	CH-12235
PA3597	CH-12825	RS3703	ST06-16054	1849107	SC14-12254	538214	CH09-12244	0005A	CH14-12245
PA3605	CH-12234	RS3714	CH-14900	1849108	CH12-11389	538235	CH12-11389	0008A	CH-12386
PA3612	CH-12397	RS3715	CH04-14412	1849109	SC12-11391	538237	CH14-12245	0009A	CH05-11106
PA3653	CH-12216	RS3724	CH-14896	1849111	ST08-11316	538239	CH08-11288	0010A	CH-12248
PA3654	CH-12215	RS3726	CH-14902	1849112	CH08-11288	541559	CH14-12245	0012A	CH-12242
PA-3669-FN	CH08-11935	RS3727	CH-16523	1849116	CH-12266	541560	CH14-12245	0014A	CH-12247
PA3675	CH-12798	RS3744	CH-16689	1849117	CH10-12224	565487	CH08-11003	0020A	CH-12091
PA3682	ST-16880	RS3870	CH-16294	1849119	CH06-11295	565526	ST09-12265	0022A	CH-12285
PA3683	ST-16876	RS3871	SC-16301	1849121	SC14-12254	565527	CH09-12244	0024A	CH-12225
PA3684	ST-16879	RS3885	ST10-15380	1849124	ST06-11315	565528	CH09-12244	0028A	CH12-12251

Cross Reference by Manufacturer



MFERS. NO.	OUR NO.	MFERS. NO.	OUR NO.	MFERS. NO.	OUR NO.	MFERS. NO.	OUR NO.	MFERS. NO.	OUR NO.
0030A	CH-16873	1987430014	CH-12247	9451160060	CH-12238	801155191	CH-12238	CFM80	CH-12207
0034A	CH-12246	1987430022	CH-12285	9451160060	CH-12242	801155196	CH-12234	CFM813	CH-12386
0036A	CH-12250	1987430024	CH-12225	9457232360	CH-12213	90801155191	CH-12238	CFM816	CH-12242
0036A	CH-16874	1987430028	CH12-12251	9457233670	CH-12250	CALSA		CFM822	CH-12235
0038A	CH-12231	1987430030	CH-16873	9457233670	CH-16874	E100267	CH-12980	CFM84	CH-12210
0042A	CH-12232	1987430034	CH-12246	BOSS TRUCKS		E100880	CH-12385	CFM85	CH-13150
0050A	CH-12660	1987430036	CH-12250	8863355	CH06-11295	E101225	CH-12386	CFM852	PF-14090
0056A	CH-12234	1987430036	CH-16874	D055379	CH-12397	E117207	CH-12231	CFM852	PFM-14095
0060A	CH-12238	1987430038	CH-12231	SX50-06	CH06-11295	E124398	ST-13531	CFM884	CH18-17230
0060A	CH-12242	1987430042	CH-12232	BOTTARINI		CANADIAN FILTER MF		CFM885	SC18-17232
1 987 430 056	CH-12234	1987430044	CH-12236	220901	CH05-11106	CFM1003	CH05-11467	CFM946	CH-12216
1 987 430 060	CH-12238	1987430050	CH-12660	220902	CH08-11003	CFM101F	CH12-12251	CFM948	CH-12215
1.457.433.900	CH-14900	1987430052	CH-12264	220903	CH10-11117	CFM132	CH-12206	CFM98	CH-12262
1457429032	CH-11348	1987430063	CH16-12253	220905	CH12-11388	CFM134F	CH05-11106	CFM982	CH-12091
1457429034	CH-12213	1987430064	SC12-11391	220913	CH-12474	CFM142	CH-12209	CFM986	CH-16873
1457429035	CH-16873	1987430066	CH-12282	220918	CH-13500	CFM2006	CH-12278	CARQUEST	
1457429039	CH-12660	1987430068	CH-11211	220981	CH08-11288	CFM202	PF-15677	87045	CH-12210
1457429073	CH-12250	1987430071	CH08-11288	BRAUD		CFM208F	CH-12275	87046	CH-13150
1457429073	CH-16874	1987430072	CH-12289	20008157	CH08-11288	CFM237	CH-12249	87047	CH-12208
1457429930	CH-12209	1987430075	ST08-11316	20008158	ST08-11316	CFM249	SC14-12254	87048	CH-13157
1457429941	CH-12231	1987430077	CH-12278	20015933	CH08-11935	CFM286	CH14-12245	87119	CH12-11389
1457429942	CH-12091	1987430078	CH-12238	20015934	ST06-12048	CFM361	CH-12269	87123	CH05-12222
1457429944	CH-12285	3236A	CH-12213	BRAY		CFM385	CH12-11389	87133	PF-15684
1457429945	CH-12225	3367A	CH-12250	61643A	CH-12262	CFM421F	CH10-11308	87142	CH08-11003
1457429946	CH-12386	3367A	CH-16874	BRIMONT		CFM432	SC12-11391	87208	CH14-12245
1457429950	CH-12385	9 457 233 220	PF-15684	1196112	CH05-11106	CFM434	SC10-11317	87209	SC14-12254
1457429966	CH-12242	9451160001	CH-12385	BROCKWAY		CFM435	SC-12274	87225	CH-12273
1457429967	CH-12248	9451160003	CH12-11389	507367	CH-12262	CFM437	CH-12269	87226	SC-12274
1457429968	CH-12234	9451160004	CH-12235	BROS		CFM538	CH-13141	87237	CH12-12251
1457429969	CH-12278	9451160005	CH14-12245	E-380069	CH-12260	CFM573F	CH08-12221	87238	CH21-17070
1457429975	CH-12235	9451160008	CH-12386	BROYT		CFM574	CH21-17070	87239	SC21-17075
1457429976	CH12-11389	9451160009	CH05-11106	2914533	SC14-12254	CFM601F	CH06-14733	87258	CH18-17230
1457429977	CH14-12245	9451160010	CH-12248	2914534	CH14-12245	CFM608	CH-12273	87259	SC18-17232
1457429979	CH-12826	9451160011	SC14-12254	BUCYRUS- ERIE		CFM617	SC21-17075	87276	CH05-11106
1457429980	CH-12236	9451160012	CH-12242	104516	CH12-12251	CFM632F	CH06-11056	87290	CH-12260
1457429982	CH-12264	9451160014	CH-12247	46134465	CH12-12251	CFM641	CH14-13356	87321	CH08-11288
1457429985	CH-12246	9451160020	CH-12091	46140232	CH10-12224	CFM642	SC14-13357	87334	CH-12214
1457429990	CH-12249	9451160022	CH-12285	46140235	CH12-12251	CFM644F	CH05-11467	87335	CH-13156
1457429991	CH-12247	9451160024	CH-12225	46140236	CH12-12251	CFM690F	CH08-11288	87336	CH-13141
1457429999	CH-11211	9451160028	CH12-12251	46140306	CH-12282	CFM75	CH-12260	87342	CH-12272
1987430001	CH-12385	9451160030	CH-16873	46140340	CH-12260	CFM76	CH-12208	87378	CH-12207
1987430003	CH12-11389	9451160036	CH-12250	46143960	CH-12262	CFM77	CH-13157	87489	CH05-11467
1987430004	CH-12235	9451160036	CH-16874	46149231	CH10-12224	CFM773	CH-12271	87503	CH08-12221
1987430005	CH14-12245	9451160038	CH-12231	46151725	CH12-12251	CFM777F	CH09-12244	87505	CH-12209
1987430008	CH-12386	9451160042	CH-12232	46163290	CH-12282	CFM78	CH-12214	87508	CH-12282
1987430009	CH05-11106	9451160044	CH-12236	46163360	CH10-12224	CFM782F	CH05-11106	87518	CH06-14733
1987430010	CH-12248	9451160050	CH-12660	62300685	SC-12252	CFM79	CH-13156	87522	CH09-12244
1987430011	SC14-12254	9451160052	CH-12264	62300686	CH16-12253	CFM791	CH-12385	87540	CH-12275
1987430012	CH-12242	9451160056	CH-12234	BUSSING		CFM799	CH-11020	87550	CH-12209

Cross Reference by Manufacturer



MFRS. NO.	OUR NO.	MFRS. NO.	OUR NO.	MFRS. NO.	OUR NO.	MFRS. NO.	OUR NO.	MFRS. NO.	OUR NO.
87595	PF-15677	88487	CH08-12228	6155539	CH05-11106	P-250599	CH09-12244	3124011-R1	CH08-12228
87608	CH-12235	88496	CH-12716	6155540	CH-11348	P450543	CH-12276	3124011-R2	CH08-12228
87609	ST-13529	88498	CH-12491	6155543	ST05-11108	P450544	SC10-11317	3124012-R1	ST08-12229
87618	CH-12268	88502	CH-14722	CARRIER		P-850501	ST09-12265	3125253-R1	ST06-12048
87630	CH-12177	88504	CH-14334	66U12155	CH05-11106	P-850550	SC-12270	3126100-R1	ST-13530
87631	CH06-11056	88510	CH-12225	66U1-5262-1	CH05-11106	P-850551	CH-12269	3135188-R1	ST08-11316
87632	ST-12226	88515	CH-12386	941070	CH04-11675	P-850561	SC12-11391	313964-R91	CH-12209
87653	CH06-12258	88517	ST-13410	CASE		P-850562	CH12-11389	3146576-R1	CH-12231
87656	CH14-13356	88522	ST08-11316	0-82571	CH04-11675	P-850568	CH-12273	3146939-R1	CH-12386
87657	SC14-13357	88525	ST-13531	1050507	CH21-17070	P-850569	SC-12274	3147878-R1	ST-16487
87679	ST06-11315	88526	CH06-11941	627975-C3	CH14-13356	R-28797	CH10-11308	3147878R2	ST-16487
87710	CH-12839	88532	ST-13530	82034441	ST-17103	R-29295	CH10-11308	3148080-R1	ST-16488
87764	CH-12262	88534	CH-12867	A-141041	CH05-11106	R-36361	SC10-11317	3153187-R1	CH08-11288
87769	ST-14343	88537	CH08-12228	A-173290	CH06-14733	R-39392	CH05-11467	3153188-R1	ST08-11316
87811	CH-12206	88538	ST08-12229	A-43656	CH16-12253	R-39393	ST-13410	3154700-R1	CH10-11308
87868	CH08-11288	88541	CH-12242	A-43657	SC-12270	S-113979	CH05-11467	3154701-R1	SC10-11317
87878	CH-12249	88546	CH-12232	A-55203	CH05-11106	S-117745	CH09-12244	3178080-R1	ST-16488
87890	CH-12262	88547	CH-12283	A-59999	CH08-12243	S-117746	ST09-12265	3210185-R1	CH12-11389
87918	CH-14104	88554	CH-12385	D-40349	CH05-11106	S-221106	CH10-12224	3216100-R1	ST-13530
87919	CH10-11308	88560	ST09-12265	D-43712	CH05-11106	S-221313	CH12-12251	3216100R2	ST-13530
87920	SC10-11317	88561	CH-12286	D-48198	CH05-11106	S-224637	CH-12266	3219420-R91	CH-12385
87921	SC10-12395	88569	ST08-14413	D-53106	CH05-11106	S-231996	CH12-11389	3219421-R1	ST-13531
87924	SC12-11391	88580	PF-14090	D-55164	CH05-11106	S-236468	CH05-11467	3226416-R1	CH-12385
87927	CH-12269	88580	PFM-14095	D-55203	CH05-11106	T-40348	CH05-11106	3282011-R91	CH-12260
87928	SC-12270	88594	CH-12234	D-55864	CH08-11288	T-40349	CH05-11106	3291210-R1	CH08-11288
87966	CH-12268	88606	CH06-11295	D-56453	CH08-11288	V-36474	CH04-11675	3371378-R1	CH09-12244
88120	PF-15683	88613	CH-13270	D-56463	CH08-11288	V-37721	CH-12386	3371379-R1	ST09-12265
88133	PF-15684	88625	CH08-11942	D-82571	CH04-11675	XA-76507	CH05-11106	3372006-R1	CH-12276
88188	CH-12206	88642	CH-12276	D-82775	ST-13410	XB-39303	CH05-11106	3375263-R1	SC12-11391
88210	CH-12847	88643	SC10-11317	E-41535	ST06-11109	XD-91927	CH06-14733	3375264-R1	CH12-11389
88263	ST05-14980	88652	CH07-14074	E-43780	CH06-11038	CASE HOUSINGS		3405458-R1	CH-12386
88270	CH04-11675	88741	CH-12278	H-425256	CH05-11106	L-13534	CH12-12251	355607-C1	CH14-12245
88274	CH-12215	88852	CH-12289	K-922630	CH-12177	CASE/INTERNATIONAL		381343-R91	CH05-11106
88294	CH-12091	88868	CH-11020	L-30937	CH12-12251	09-060	CH10-11308	389263-R91	CH08-12243
88313	CH-12397	CARRARO		L-33913	CH10-12224	1105717-C1	CH08-11288	389567-R91	CH05-11106
88327	CH-12272	45401	CH-10677	L-35495	CH14-12245	1269652-C1	CH04-11675	4003012-R1	CH-12266
88328	CH-12247	45409	CH08-11003	L-35496	SC14-12254	146939-R1	CH-12386	423448-R91	CH-12262
88330	CH-12285	45449	SC06-11269	L-52042	CH08-12243	155209-H2	CH-12262	450879-C1	CH-12268
88351	CH-12213	45450	CH06-11255	L-82775	CH08-11288	1966965-C1	CH08-11003	460803-C1	CH-12282
88352	CH-12403	45452	SC08-11253	N-6656	CH-12269	222421A1	CH08-14410	461249-C1	CH12-11389
88360	CH05-11106	45453	CH08-11003	N-6660	SC12-11391	222422A1	ST08-14413	465249-C1	CH12-11389
88375	ST08-11110	CARRARO ANTONIO		N-6778	CH06-14733	265119-C91	CH-12262	529821-R1	CH12-11389
88378	CH-12605	44509001	CH05-11467	N-7028	CH09-12244	285016A1	ST06-11109	529821-R2	CH12-11389
88407	ST-14715	45305277	PF-15858	N-8153	ST08-11316	3039972-R1	SC-12252	529852-R2	ST06-11315
88408	CH-12485	45305278	PF-15859	P-1050506	SC21-17075	3066498-R91	CH05-11106	529852-R3	ST06-11315
88414	CH-12248	45305574	PF-15860	P-1050507	CH21-17070	3115559-R91	ST08-12229	529852-R4	ST06-11315
88430	CH-12231	45305768	PF-15866	P2150506	SC10-12395	3115560-R2	ST06-12048	529852-R5	ST06-11315
88466	CH08-12228	48013048	PF-15862	P250566	ST06-11315	3115560-R91	CH08-12228	530270-R2	SC12-11391
88467	ST08-12229	6155529	CH06-11056	P250581	ST08-11316	3115569-R2	ST06-12048	537335-R1	ST-12226

Cross Reference by Manufacturer



MFRS. NO.	OUR NO.	MFRS. NO.	OUR NO.	MFRS. NO.	OUR NO.	MFRS. NO.	OUR NO.	MFRS. NO.	OUR NO.
537335-R2	ST-12226	310799	CH14-12245	7W-3920	CH-12207	CESAB		LAF-5054A	CH-12275
537335-R3	ST-12226	310836	CH-12386	7W-5316	CH-12210	0991322	CH06-11255	LAF-5368	CH08-11288
619689-C91	CH-12260	310925	CH-12269	7W-5317	CH-12214	0991323	SC06-11246	LAF-6587	CH12-11389
6278976-C1	SC14-13357	310929	CH05-11106	7W-5389	CH-12208	0991673	CH06-11295	LAF-6769	CH14-12245
627975-C2	CH14-13356	3I-2147	CH05-15887	7W-7424	CH-12268	0991674	ST06-11315	LAF-6834	SC12-11391
627976-C1	SC14-13357	3N-3740	CH-12260	7X6041	PF-15669	CHAMP		LAF-7092	CH-12282
702322-C1	CH14-12245	3R-7714	CH-12260	8C-3047	SC14-12254	AF-1031	PF-15684	LAF-7797	CH-12268
702323-C1	SC14-12254	427334	SC-12270	8M-8047	CH-12208	AF-1275	CH05-11106	LAF-8211	CH14-13356
702753-C1	SC-12274	4G-3137	CH-12260	8N-5316	CH-12210	AF-1418	CH12-11389	LAF-8668	CH10-11308
808040-R1	CH-12272	4M-0383	CH-12208	8N-5317	CH-12214	AF-15	PF-14090	LAF-8674	SC10-11317
848623-R1	SC12-11391	4M-2976	CH-12207	8N-5373	CH-12214	AF-15	PFM-14095	LAF-9085	SC-12274
886017-C92	CH10-12224	4M-3803	CH-12260	8N-5389	CH-12208	AF-1625	SC10-11317	LAF-9155	CH-12266
924280-C1	SC10-12395	4M-3976	CH-12207	8N-5911	CH-12210	AF-1853M	CH-12268	LAF-9200	CH-12269
924779-C1	CH06-11056	4M-8047	CH-12208	8N-6309	CH-12403	AF-229	CH-12209	CHAMPION	
924779-C2	CH06-11056	4M-8048	CH-13157	8T-5600	CH12-11389	AF-237	CH12-12251	1523749	CH-12775
926783-C1	CH14-12245	4M-9334	CH-12214	8T-6305	CH08-11288	AF-265HD	CH-12262	3325106	CH09-12244
926784-C1	SC14-12254	4M-9335	CH-13156	8T7462	CH09-12244	AF-2745A	CH04-11675	LAF4127/15-2283	CH05-12222
MHC203252	CH-12385	4M-9339	CH-13156	8T-8076	CH14-12245	AF-290A	CH-12260	LAF4139/15-2284	CH08-12228
TRA8273235	ST-13410	4M-9378	CH-12207	8U2601	CH09-12244	AF-300	PF-15684	LAF4177/15-2287	CH06-12258
Z2950577	ST08-14413	4M-9387	CH-12207	946352	SC12-11391	AF-334	CH-12214	LAF4322/15-2292	CH-12232
CATERPILLAR		4N-0015	PF-14090	971217	CH05-11106	AF-335	CH-13156	LAF4345/15-2294	CH-12215
096-9624	CH14-12245	4N-0015	PFM-14095	9L-0699	CH-12214	AF-47	CH-12208	LAF4514	CH-12775
100-6846	CH10-12390	4N-0313	CH-12272	9M-1827	CH-12214	AF-4747	CH08-12221	W705	CH-12386
100-6846	CH10-14455	4N-0313X	CH-12272	9S-9972	CH-13141	AF-5054A	CH-12275	W706	CH-12285
1011460	CH-12272	4N-0326	CH-12271	9Y-6803	SC-12252	AF-5368	CH08-11288	W711	CH-12231
1106326	CH08-17365	5W-2716	ST09-12265	9Y-6804	SC14-12254	AF-602	PF-15683	CHAMPION ROAD MAC	
1106331	ST08-14413	5W-2717	CH-12286	9Y-6805	SC12-11391	AF-6769	CH14-12245	11564	SC-12274
1348726	CH06-16050	5W-3402	SC10-11317	9Y-6806	SC10-11317	AF-6834	SC12-11391	16306	SC-12270
1402337	ST06-16054	5W-3403	CH-12276	9Y-6807	ST-13410	AF-7092	CH-12282	16307	CH-12269
1421340	CH-16922	5W-5889	CH08-11288	9Y-6817	CH06-11056	AF-8211	CH14-13356	24149	CH09-12244
1N-4864	SC18-17232	5W-5890	ST08-11316	9Y-6821	ST-12226	AF-8216	SC14-13357	24150	ST09-12265
1S-1286	CH-13156	6A-5110	CH-12386	9Y-6823	ST08-11110	AF-8668	CH10-11308	CHARLES MACHINE W	
1S-1287	CH-13150	6A-5110V	CH-12386	9Y-6826	CH-12209	AF-9085	SC-12274	195-426	CH05-11106
1W-0392	CH-12207	6A-5162	CH-12397	9Y-6828	CH14-12245	AF-9778	ST09-12265	195-427	CH05-11106
1W-3636	SC21-17075	6A-5162V	CH-12397	9Y-6833	CH-12262	LAF-1275	CH05-11106	195-671	CH05-11106
1W-3637	CH21-17070	6I6582	SC12-11391	9Y6834	CH12-12251	LAF-131	CH-12209	195-682	CH05-11106
21685	CH-12269	6L-3313	CH-12260	9Y-6836	CH18-17230	LAF-237	CH12-12251	195-703	CH09-12244
2P-8863	CH-12214	6L-4714	PF-15677	9Y-6839	CH05-11106	LAF-265	CH-12262	195-709	CH09-12244
2S-1285	CH-13157	6L-6873	PF-15677	9Y-6842	CH06-14733	LAF-265HD	CH-12262	195-711	CH08-12243
2S-1286	CH-13156	6N-6064	CH-12273	9Y-6843	CH10-11308	LAF-2745A	CH04-11675	195-735	CH08-11003
2S-1287	CH-13150	6N-6065	SC-12274	9Y-6846	CH05-11467	LAF-281	CH05-11467	CHICAGO-PNEUMATIC	
2S-3087	CH-12208	774592	CH14-12245	9Y-6853	CH-12605	LAF-290A	CH-12260	15PS-2690	CH08-12243
3C0183	CH-12209	775869	CH12-12251	9Y-7802	SC-12270	LAF-334	CH-12214	56PS-4670	SC-12274
3C0183E	CH-12209	776258	SC14-12254	9Y-7805	SC12-11391	LAF-335	CH-13156	6PS-2690	CH08-12243
3I0105	SC21-17075	7E-0973	CH-12286	9Y-7808	CH12-11389	LAF-45	CH-12210	75PS-2690	CH12-12251
3I0126	SC14-12254	7E0974	CH09-12244	9Y-7810	CH-12269	LAF-46	CH-13150	CHRYSLER	
3I0167	ST-14343	7E0975	CH08-11288	9Y-7811	CH14-12245	LAF-47	CH-12208	1852569	PF-14090
3I0215	SC18-17232	7M-9045	CH-12210	9Y-7813	CH08-11288	LAF-4714	PF-15677	1852569	PFM-14095
3I0795	CH18-17230	7M-9046	CH-13150	9Y-7814	CH09-12244	LAF-48	CH-13157	3401261	CH08-12243

Cross Reference by Manufacturer



MFRS. NO.	OUR NO.	MFRS. NO.	OUR NO.	MFRS. NO.	OUR NO.	MFRS. NO.	OUR NO.	MFRS. NO.	OUR NO.
3401368	CH08-12243	2311778	CH05-11106	993689	SC12-11391	1077A12300	CH12-12251	PCA502	CH-12283
4213582	PF-15683	2318016	CH05-11106	HCF-11054	CH-12262	1078A30930	CH14-12245	PCA502SY	SC-12252
4213583	PF-15684	282461-3	CH05-11106	HCF-11590	CH08-12243	1078A31300	CH12-11389	PCA507	CH14-12245
4227087	PF-15683	317042	CH-12262	HCF-14205	CH08-12243	6486	CH05-11106	PCA507SY	SC14-12254
4241042	PF-15684	333494	CH05-11106	HCF-15919	CH08-12243	98262/5025	CH14-12245	PCA510	CH08-12221
4306113	PF-15683	335494	CH05-11106	CLARK/TEREX		A13316774	CH08-14410	PCA523	CH12-11389
4342800	PF-15684	335498	CH05-11106	945059	CH12-12251	A13368674	CH-16294	PCA523SY	SC12-11391
4342801	PF-15683	3493878	CH05-11106	CLEAN		A2950436	CH-17512	PCA535	CH-12273
75060642	CH12-11389	4149908	CH06-11295	MA384	CH12-11389	C11153/1014	CH-12386	PCA535SY	SC-12274
CLAAS		4155107	ST-13527	MA521	CH-12282	C11158/1014	CH-12386	PCA536	CH-12266
03414540	CH-12209	5209957	CH10-11308	MA567	CH-12278	C11158/1041	CH-12242	PCA546	CH10-11308
03414590	CH-12867	616513	CH05-11106	MA744	CH-12809	C11561724	CH08-11288	PCA546SY	SC10-11317
03417790	CH05-11106	621128	CH-12208	CLEVELAND		C16012/52	CH-12285	PCA563	CH-12269
070-905	CH-12278	630710	CH-12207	9832046	CH14-12245	C16012052	CH-12285	PCA563SY	SC-12270
071-242	CH-12278	6518192	CH05-11106	9832047	SC14-12254	C16012189	CH-12385	PCA6526	CH-12249
072239.0	ST-13528	6544578	CH05-11106	CLIMAX		C16012190	CH-12242	PCA7087	PF-15683
077382.0	ST-17470	6598222	ST05-14980	10CX-49	CH12-12251	DP60533-2	ST-14787	CONTINENTAL	
176 168.0	ST-13531	6598362	ST-14343	172121	CH12-12251	R01000/89	CH-12177	F-227F-502	CH05-11106
176-168	ST-13531	6598491	CH05-11106	COFAM		CONOCO		LO-176	CH05-11106
176-169	ST-13530	6598898	ST06-11315	NCM101	CH05-11106	CNA-3559	PF-15683	COOK BROS.	
176169.0	ST-13530	6620140	CH05-11106	NCM109	CH-12272	CONSOLIDATED PNEU		612-6305	CH-12262
177046.0	CH-12242	6630939	CH06-14733	COLES		6-55FPS1087	CH12-11389	COOPERS	
178 429.1	ST-13530	6663418	CH05-11106	552894	CH12-12251	CONTINENTA		4418	CH-12206
320002.0	ST08-11110	6666376	ST07-14270	726960	CH12-12251	PCA1532	CH06-14733	4807/2T	CH-12206
643.169.0	CH-12235	886544	CH05-11106	8283485	CH14-12245	PCA1543SY	ST06-11315	4807T	CH-12206
643-331	ST-13529	889097	CH05-11106	8351075	CH14-12245	PCA1544SY	ST08-11316	5040T	CH-12177
643331.0	ST-13529	889098	CH05-11106	8576344	CH12-12251	PCA1570	CH21-17070	5223/8T	CH-12249
657564.0	ST-13527	890991	CH-12262	8584532	CH12-11389	PCA1570SY	SC21-17075	5296T	CH-12839
676-600	CH-12386	891873	CH-12262	8729984	CH12-11389	PCA216	CH-12207	6489T	CH-12212
677-434	CH-12385	896056	CH-12209	8729998	CH-12262	PCA224	CH-12208	AA348T	CH06-12258
677-4340	CH-12385	897064	CH04-11675	8752811	CH12-11389	PCA226	CH-12214	AEK2030	CH-12275
723-561	CH-12231	933688	CH12-11389	8754231	CH14-12245	PCA226SY	CH-13141	AEK2046	CH05-11467
940-084	ST-13531	933689	SC12-11391	8755193	PF-15680	PCA229	CH-12209	AEK2128	CH06-14733
942084.0	ST-13531	944404	CH14-12245	8779594	CH10-11308	PCA233	CH-12210	AEK2494	CH06-11056
CLARK		945059	CH12-12251	8935978	CH14-12245	PCA234	CH-13150	AEK2522	CH-12290
1503857	CH10-11308	946847	CH14-12245	8970415	CH14-12245	PCA236	CH-13156	AEK2568	CH-13270
1514669	SC-12252	946897	CH14-12245	8973286	CH12-11389	PCA237	CH-13157	AEK2574	CH-13473
1564805	SC-12270	948313	CH10-11308	8975053	CH12-11389	PCA244	CH-12260	AEK2576	CH-12770
1564806	CH-12269	949363	SC-12252	8985294	CH-12225	PCA2523	CH09-12244	AEK2578	CH08-14835
15H-668	CH05-11106	949524	SC-12274	8987765	CH09-12244	PCA2523SY	ST09-12265	AEK2584	CH-12770
1616513	CH05-11106	949525	CH-12273	COLT INDUSTRIES		PCA254	CH10-12224	AEK2608	CH10-12390
161WA-653	CH12-12251	960243	CH14-12245	20803	SC14-12254	PCA256	CH05-11106	AEK2608	CH10-14455
1624567	CH08-12243	961000	CH09-12244	20804	CH14-12245	PCA2571	PF-14090	AEM2000	CH-12289
1642645	CH05-11106	961001	ST09-12265	21097	CH12-12251	PCA2571	PFM-14095	AEM2014	CH18-17230
1704269	CH05-11106	961161	SC-12274	21100	CH10-12224	PCA258	CH08-11003	AEM2022	CH21-17070
1727868	CH08-12243	966538	CH-12266	22274	CH08-12243	PCA2595	CH18-17230	AEM2026	CH-12271
1911724	SC14-12254	993608	CH12-11389	22344	CH08-11003	PCA2595SY	SC18-17232	AEM2050	CH-15565
1911725	SC12-11391	993609	SC12-11391	22345	CH06-11038	PCA3280	CH-12235	AEM2068	CH-12604
1990248	CH12-11389	993688	CH12-11389	COMPAIR		PCA3660	PF-15684	AEM2076	CH14-13356

Cross Reference by Manufacturer



MFRS. NO.	OUR NO.	MFRS. NO.	OUR NO.	MFRS. NO.	OUR NO.	MFRS. NO.	OUR NO.	MFRS. NO.	OUR NO.
AEM2090	CH-12500	AG142	CH-12839	AZA169	CH-12234	AZA367	ST09-12265	AZC250	CH12-11389
AEM2102	CH-12264	AG265	PF-15684	AZA170	CH-12236	AZA373	CH05-12222	AZC251	CH12-11389
AEM2128	CH06-14733	AG373	CH-12249	AZA171	CH-16873	AZA374T	SC10-11317	AZC252	CH12-12251
AEM2134	CH-12236	AG381	CH-12209	AZA175	CH-12246	AZA375	CH-12276	AZC253	CH12-12251
AEM2136	CH-12216	AG383	CH-12213	AZA176	CH-12247	AZA376	ST08-11110	AZC254	CH12-11389
AEM2138	CH-12216	AG385	CH-12660	AZA177	CH-12248	AZA376T	ST08-11110	AZC255	SC12-11391
AEM2154	CH-12282	AG417	CH-12826	AZA179T	CH-12752	AZA386	CH06-11941	AZC300	CH14-12245
AEM2176	CH-12302	AG419	CH-12206	AZA181	CH-12268	AZA409	CH-13090	AZC301	CH14-12245
AEM2188	CH-11348	AG445	CH-12660	AZA189	CH-11211	AZA421	CH-12781	AZC303	SC14-12254
AEM2486	CH14-12245	AG464	PF-15680	AZA189T	CH-11211	AZA430	CH-13050	AZF003 (AIR)	CH-12839
AEM2496	CH-12286	AG579	CH-12250	AZA197T	CH-12867	AZA443	ST-13531	AZF004 (AIR)	CH-12206
AEM2510	CH-14104	AG579	CH-16874	AZA203	ST-13530	AZA446	ST-13527	AZF005	CH-12206
AEM2512	CH-12209	AZA003	CH-12839	AZA203T	ST-13530	AZA450	ST-13529	AZF008 (AIR)	CH-12177
AEM2542	CH12-11343	AZA003T	CH-12839	AZA204	CH-12285	AZA462	CH-12283	AZF009 (AIR)	CH-12249
AEM2542	CH-13477	AZA004	CH-12206	AZA251	CH-12857	AZA464A	CH-12283	DU1206S	CH12-11389
AEM2556	CH-12825	AZA005	CH-12206	AZA251T	CH-12857	AZA485	CH-12953	DU1206TS	CH12-11389
AEM2560	CH-13185	AZA008	CH-12177	AZA309	CH12-11389	AZA510	CH-12273	DU1233S	CH12-12251
AEM2630	CH-12775	AZA008T	CH-12177	AZA309T	CH12-11389	AZA511	SC-12274	DU1233TS	CH12-12251
AEM2632	CH-14107	AZA009	CH-12212	AZA311	CH12-12251	AZA511T	SC-12274	DU1260S	CH-12260
AEM2752	CH-16689	AZA009T	CH-12212	AZA311T	CH12-12251	AZA512	CH-12269	DU1454	CH-12653
AEP3514	PF-15677	AZA025	CH-12249	AZA313	CH-12653	AZA513	SC-12270	DU1518S	CH14-12245
AEP3515	PF-14090	AZA025T	CH-12249	AZA314	CH14-12245	AZA514	CH21-17070	DU1518TS	CH14-12245
AEP3515	PFM-14095	AZA042	CH-12385	AZA314T	CH14-12245	AZA515	SC21-17075	DU1705T	CH08-11288
AEP3516	PF-15686	AZA043	CH-12250	AZA319	CH08-11288	AZA602	CH-12208	DU2222	CH08-11288
AEP3518	PF-15690	AZA043	CH-16874	AZA319T	CH08-11288	AZA604	CH-13157	DU2231	ST08-11316
AEP3519	PF-15693	AZA043T	CH-12250	AZA323T	SC-12252	AZA608	CH-12207	DU2354	CH08-12228
AES2015	SC18-17232	AZA043T	CH-16874	AZA324T	CH16-12253	AZA609	CH-12214	DU2399	CH05-11106
AES2023	SC21-17075	AZA044	CH-12213	AZA326	SC12-11391	AZA610	CH-13156	DU345S	CH-12262
AES2027	CH-12272	AZA044T	CH-12213	AZA326T	SC12-11391	AZA611	CH-13150	DU664S	CH05-11106
AES2045	ST-14343	AZA045	PF-15680	AZA327	CH10-11308	AZA612	CH-12210	DU664TS	CH05-11106
AES2047	ST-13410	AZA089	CH-12209	AZA328	SC10-11317	AZA815	CH-12278	EAP3518	PF-15690
AES2051	SC-15604	AZA098	CH-12209	AZA328T	SC10-11317	AZA852	CH-12387	L95-407	CH-12653
AES2069	CH-12605	AZA101	CH-12386	AZA332	CH08-11288	AZA856	CH-12387	L95-408	CH12-11389
AES2077	SC14-13357	AZA123	CH-12980	AZA332T	CH08-11288	AZA863	CH-12809	L95-409	CH-12262
AES2091	CH-12279	AZA126	CH-12397	AZA333	ST08-11316	AZA885	CH-15300	L95-412K	CH12-12251
AES2265	ST06-11315	AZA127	CH-12238	AZA333T	ST08-11316	AZA894	CH-14107	L95-414K	CH05-11106
AES2279	ST06-11109	AZA128	CH-12235	AZA335	ST08-12229	AZB100	CH-12262	L95-417	CH-12826
AES2281	ST-16488	AZA128T	CH-12235	AZA336	CH08-12228	AZB201	CH-12260	L95-419	CH14-12245
AES2283	ST-13528	AZA129	CH-12231	AZA337	CH05-11106	AZC001	CH05-11106	L95-423	CH-12208
AES2285	ST-16487	AZA132	CH-12242	AZA337T	CH05-11106	AZC002	CH05-11106	L95-424	CH-12210
AES2287	CH-13141	AZA147	CH-12826	AZA340	CH08-11288	AZC005	CH05-11106	L95-425	CH-12214
AES2391	CH-12225	AZA150	CH-12264	AZA343	SC14-12254	AZC054	CH-12653	L95-426	CH-12207
AES2495	ST-12226	AZA151	CH-12660	AZA343T	SC14-12254	AZC105	CH08-11288	L95-431	CH-12209
AES2523	ST-14113	AZA157	CH-12215	AZA348	CH06-12258	AZC107	ST08-11316	L95-432	CH-12213
AES2563	ST-14787	AZA158	CH-12216	AZA351	CH06-11295	AZC108	CH08-11288	L95-434	CH-12250
AES2595	ST-16938	AZA159	CH-12091	AZA363	CH04-11675	AZC109	ST08-12229	L95-434	CH-16874
AES2609	SC10-12395	AZA165	CH05-12222	AZA364	ST-12226	AZC110	CH08-12221	L95-445	CH-12660
AG108	CH-12206	AZA166	CH-12225	AZA365	CH06-11056	AZC206	CH10-11308	COOPERS HOUSINGS	
AG140	CH-12177	AZA168	CH-12232	AZA366	CH09-12244	AZC207	SC10-11317	CD 2502	CH10-11308

Cross Reference by Manufacturer



MFRS. NO.	OUR NO.	MFRS. NO.	OUR NO.	MFRS. NO.	OUR NO.	MFRS. NO.	OUR NO.	MFRS. NO.	OUR NO.	
CD 2504	CH10-11308	9576	CH-11211	9729	ST-16876	3013207	SC-12252	PMA-10-2745K	CH04-11675	
CD1302	CH05-11106	9577	CH-12213	9732K	CH08-11935	3013208	CH14-12245	PMA-10-3951	PF-15677	
CD1304	CH05-11106	9580	CH-13156	9733K	CH-13270	3013209	SC14-12254	PMA-10-5043K	CH08-12221	
CD2002	CH08-11288	9586	CH-13157	9735	ST06-12048	3013212	CH18-17230	PMA-10-5054K	CH-12275	
CD2004	CH08-11288	9587	CH-12289	9739K	CH-13811	3013213	SC18-17232	PMA-10-5368K	CH08-11288	
CD3002	CH12-11389	9588	CH-12207	9742	CH-12234	3230272	CH12-11389	PMA-10-6587	CH12-11389	
CD3004	CH12-11389	9590	CH-12752	9745	ST-13529	3230273	SC12-11391	PMA-10-6769	CH14-12245	
CD3502	CH14-12245	9591	CH-12247	9748	ST-16880	3315187	CH12-11389	PMA-10-6775	SC14-12254	
CD3504	CH14-12245	9592	CH-12283	9749	CH-14107	3318279	CH05-11106	PMA-10-8668K	CH10-11308	
COVENTRY CLIMAX		9595	CH-12867	9750	ST-13528	3325291	SC14-12254	PMA-10-8674	SC10-11317	
PBC-257001	CH-12209	9597K	CH06-12258	9751	CH-12282	3325292	CH14-12245	PMA-10-8736	CH05-12222	
CROSLAND		9599	CH-12781	9765	CH-12825	3353440	CH-12385	PMA-10-9085	SC-12274	
746	CH12-11389	9611K	CH06-11295	9766	CH-12236	3429703	PF-14910	PMA-10-9200	CH-12269	
8006	PF-15686	9613	ST06-11315	9776	ST-14787	3905241	CH08-12243	PMA-10-9206	SC-12270	
8040	CH-14211	9615	CH-12225	9779	CH-13185	650152	CH12-11389	PMA-11-7092	CH-12282	
810	CH-12839	9617	SC12-11391	977K	CH08-11288	650930	CH14-12245	PMA-11-7781	SC21-17075	
8243K	CH-12345	9618	ST08-11316	9783	CH08-17365	701419	CH-12262	PMA-11-7782	CH21-17070	
830	CH-12177	962K	CH05-11106	9784	ST08-14413	706396	CH12-12251	PMA-11-7797	CH-12268	
838	CH-11348	9630	CH-12264	9795	CH-15294	706425	CH12-11389	PMA-11-8211	CH14-13356	
9008	PF-15686	9631	CH-12232	9796	CH-12507	707664	CH-12260	PMA-11-8216	SC14-13357	
9009	CH-12953	9635	SC10-11317	9799	CH05-14409	D-58544-A	CH-12262	PMA-11-9649	ST-12226	
9062	PF-15683	9638	CH-12276	992	CH-12212	CUMMINS HOUSINGS			PMA-1424HD	CH12-11389
9130	CH-12215	9640	SC14-12254	997K	CH08-11288	133747	CH-12262	PMA-17064K	CH-12262	
920K	PF-15680	9647	CH-12278	998	CH-12249	151607	CH-12262	PMA-192HD	CH-12177	
921	CH-12213	9648	ST-13527	CUMMINS		151612	CH-12260	PMA-250C110	CH-12209	
9226	PF-15690	9649	ST-13530	133750	CH-12262	156768	CH12-12251	PMA-250C5S	CH-12209	
9264	PF-15693	964K	CH12-12251	133756	CH-12262	156769	CH12-12251	PMA-316HD	CH-12206	
944	CH12-11389	965	CH14-12245	1507449	CH-12262	160017	CH-12262	PMA-46976	CH-14104	
9508	CH-12250	9650	ST-13531	153712	CH-12262	184379	CH-12262	PMA-4M8047	CH-12208	
9508	CH-16874	9652	CH-12210	154012	CH-12260	196676	CH10-11308	PMA-4M8048	CH-13157	
9510	CH-12385	9653	CH-13150	158876	CH10-12224	204623	CH10-11308	PMA-4M9334	CH-12214	
9516K	CH08-12228	9654K	CH09-12244	196677	CH10-11308	204662	CH-12260	PMA-4M9335	CH-13156	
952	CH-12660	9655	ST09-12265	204538	CH14-12245	650577	CH14-12245	PMA-4M9378	CH-12207	
9522	CH-12235	9659	CH-12285	204624	SC10-11317	701195	CH-12262	PMA-6500HD	CH-12847	
9523	CH-16873	9661	CH-13050	204631	CH12-11389	702415	CH-12262	PMA-722HD	CH-12271	
9527K	CH10-11308	9664	CH-12857	204632	SC12-11391	708748	CH14-12245	PMA-7M9045	CH-12210	
9529	CH-12980	9665	ST-16487	204635	CH16-12253	CUSTOM VACUUM			PMA-7M9046	CH-13150
9532	CH-12397	9667	ST-16488	204636	SC-12252	6-4520-0	CH05-11106	DAEWOO		
9533	CH-12238	9670	CH-12809	204638	CH14-12245	6-4520-002	CH05-11106	2471-9023	CH-12345	
9550	CH-12248	9673	CH-12491	204639	SC14-12254	6-4545-0	CH05-11106	2474-6025	SC12-11391	
9551	CH-12386	9674	CH-12485	253290	CH-12210	6-4545-005	CH05-11106	2474-9015	CH08-11288	
9552	CH-12214	9681K	CH06-11056	253333	CH-12208	CYCLONE			2474-9019	SC10-11317
9553	CH-12208	9682	ST-12226	253341	CH-12207	PMA-10-0890K	CH-12262	2474-9020	CH10-11308	
9555	CH-12826	969	CH-12653	253565	CH-13150	PMA-10-1237	CH12-12251	9474-9001	CH-12798	
9556	CH-12242	9705K	CH06-11941	299286	CH-12262	PMA-10-1237K	CH12-12251	9474-9002	SC10-12395	
9560K	CH08-12221	9714	CH-12387	299353	CH12-12251	PMA-10-1246	CH08-12243	DAF		
9561	CH-12231	9715	CH-13090	299354	CH-12262	PMA-10-1275K	CH05-11106	0691 733	CH-12231	
9572	CH-12273	9722K	CH-12770	299418	CH12-11389	PMA-10-2090K	CH-12260	110376	CH-16873	
9573	SC-12274	9724	ST-14343	3013206	CH16-12253	PMA-10-2745	CH04-11675	1295090	CH-16689	

Cross Reference by Manufacturer



MFRS. NO.	OUR NO.	MFRS. NO.	OUR NO.	MFRS. NO.	OUR NO.	MFRS. NO.	OUR NO.	MFRS. NO.	OUR NO.
393561	CH-14107	765 AIR	CH-12273	610826/1	CH10-11308	FC201	CH06-11295	ECB10-0094	DL-17163
505412	CH-12232	768 AIR	SC10-11317	DEUTZ		FC202	CH09-12244	ECB10-5006	DL-16141
506337	CH-16873	785 AIR	ST06-11315	01319822	PF-16800	FC212	CH08-11288	ECB10-5013	DL-16864
607179	CH-12235	789 AIR	CH-14104	2165044	CH-12386	FC214	ST08-11316	ECB12-0439	DL-17111
691280	ST-13529	820 AIR	SC-12270	2243946	ST-13527	FC215	ST06-11315	ECB12-5011	DL-15751
692380	ST-13531	835 AIR	CH14-12245	2415950	ST-13530	FC216	SC10-11317	ECC06-5001	DL-17710
694218	CH-12278	836 AIR	CH12-11389	4384103	CH-12225	FC217	CH-12235	ECC06-5003	DL-17330
695633	CH-12386	K480 AIR	CH05-11106	DIAMOND		FC218	CH-16873	ECC08-5001	DL-17333
DAIHATSU		K532 AIR	CH-12262	DX0143/1	CH-12870	FC220	CH-12231	ECC08-5002	DL-17331
17801-87601	CH08-11837	K567 AIR	CH08-11288	DX1722	CH-12980	FC221	CH-12225	ECC08-5004	DL-17329
DART		K591 AIR	CH12-12251	DX211	CH-13141	FC222	CH12-12251	ECC08-5035	DL-17852
30-4127	CH-12262	K592 AIR	CH05-12222	DX214	CH-13157	DIVERSIFIED IND.		ECC10-5003	DL-17823
30-4217	CH-12262	K685AIR	CH04-11675	DX215	CH-13156	EDC032	CH-12273	ECC10-5004	DL-17335
DAVEY		K703 AIR	CH08-12221	DX2319	CH-12209	DOMINION		ECC12-50004	DL-17336
A-49329	CH08-12243	K705 AIR	CH08-11288	DX302	CH-12386	11564	SC-12274	ECD06-5008	DL-17332
A-60743	CH12-12251	K706 AIR	CH-12275	DX307	CH-12397	11565	CH-12273	P01-7064	CH-12262
C-46155	CH08-12243	K767 AIR	CH10-11308	DX3088	CH-12264	16306	SC-12270	P01-8706	CH-12210
T-40348	CH05-11106	K783 AIR	CH09-12244	DX309	CH-12225	16307	CH-12269	P01-8709	CH-12208
DAVID BROWN		DEMAG		DX311	CH-12285	DONALDSON		P01-9159	CH-12214
922630	CH-12177	004 051 74	CH-12385	DX3126	CH-12207	900635	CH-12225	P01-9167	CH-12207
DAVIS		040 050 74	CH-12386	DX315	CH-13150	DU-1206T	CH12-11389	P10-0590	CH-12262
146290	CH05-11106	0746444	CH-12242	DX3760	CH-12249	DU-1233	CH12-12251	P10-0890	CH-12262
149534	CH05-11106	295 043 76	CH-12385	DX380	CH-12273	DU-1518T	CH14-12245	P10-1203	CH-12262
152553	CH05-11106	29504356	CH-12235	DX381	SC-12274	DU-2353.T	ST08-12229	P10-1237	CH12-12251
8J-37-14629	CH05-11106	29504476	CH-12285	DX3842	CH-12216	DU-2354	CH08-12228	P10-1275	CH05-11106
DELUXE		394 686 40	ST-13530	DX3843	CH-12215	DU-664	CH05-11106	P10-2090	CH-12260
302 AIR	PF-14090	4278774	CH-12235	DX395	CH-12826	DU-770CT	CH08-11003	P10-2237	CH-12260
302 AIR	PFM-14095	5150574	CH06-11295	DX4043	CH-12248	DU-770T	CH08-11003	P102525	CH12-12251
474 AIR	CH08-12243	515162	CH10-11308	DX610	CH-12208	DU-879/2	CH10-12224	P10-2745	CH04-11675
477 AIR	SC12-11391	76141573	CH18-17230	DX613	CH-12214	DU-879T	CH10-12224	P10-3688	PF-15677
480 AIR	CH05-11106	76141673	SC18-17232	DX674	CH-12262	E50-0075	CH-12653	P10-3951	PF-15677
497 AIR	CH-12210	901069	CH05-11106	L3	CH-12091	E50-0150	CH05-11106	P10-4384	CH-13157
498 AIR	CH-13150	956571	CH06-11295	DIAMOND T		E50-0667	CH05-11555	P10-4385	CH-13156
499 AIR	CH-12214	964013	CH-12386	3107368-H2	CH12-11389	E50-1042	CH06-11056	P10-4387	CH-13150
567 AIR	CH08-11288	973 879 73	CH-12345	888686-H2	CH-12262	E70-0119	CH08-11288	P10-5043	CH08-12221
569 AIR	ST08-11316	988 633	CH-12273	896688-H2	CH12-12251	E70-0127	CH06-11295	P10-5054	CH-12275
577 AIR	ST09-12265	988 634	SC-12274	ND-104344-A	CH-12262	EAF5002	CH16-12253	P10-5368	CH08-11288
589 AIR	CH-12403	988575	CH-12285	P-2881	CH-12262	EAF5034	CH12-11389	P10-5555	CH04-11675
597 AIR	CH-12207	988585	CH-12385	DIGOMAT		EAF5039	CH-12266	P10-5629	CH05-11106
598 AIR	CH-13157	988595	ST-13531	DGML 01128	ST-14343	EAF5040	CH21-17070	P10-5961	PF-15677
599 AIR	CH-12208	988596	CH-12235	DGMMO1378K	CH04-11675	EAF5041	CH-12273	P10-6273	CH-12262
600 AIR	CH-13156	988673	CH-12278	DGMO1378K	CH04-11675	EAF5042	CH18-17230	P10-6278	CH-12260
653 AIR	PF-15677	988674	ST-13528	DITEX		EAF5044	CH-12269	P10-6587	CH12-11389
683 AIR	SC21-17075	988740	ST-13530	FC102	CH-12232	EAF5046	CH14-12245	P10-6769	CH14-12245
684 AIR	CH21-17070	988765	ST-13529	FC103	CH10-11308	ECB08-5001	DL-16550	P10-6775	SC14-12254
689 AIR	CH-12269	988766	CH-12242	FC104	CH12-11389	ECB08-5011	DL-16560	P10-6834	SC12-11391
695 AIR	CH-12209	988767	ST-13527	FC105	CH-12386	ECB08-5024	DL-16862	P10-7672	CH14-12245
763 AIR	SC14-12254	DENNIS		FC106	CH-12385	ECB08-5034	DL-16859	P10-7868	CH08-11288
764 AIR	SC-12274	606341/2	CH12-12251	FC109	CH-12248	ECB08-5056	DL-17114	P10-8668	CH10-11308

Cross Reference by Manufacturer



MFRS. NO.	OUR NO.	MFRS. NO.	OUR NO.	MFRS. NO.	OUR NO.	MFRS. NO.	OUR NO.	MFRS. NO.	OUR NO.
P10-8674	SC10-11317	P11-8678	CH-12275	P12-1675	CH14-12245	P12-9200	CH-12269	P13-6390	CH-12209
P10-8736	CH05-12222	P11-9100	CH09-12244	P12-2026	ST08-11316	P12-9610	CH21-17070	P13-6399	CH-12212
P10-9085	SC-12274	P11-9135	CH06-11295	P12-2073	CH08-11288	P13-0502	CH-12286	P13-6657	SC-12274
P10-9200	CH-12269	P11-9136	CH08-11288	P12-2074	ST08-11316	P13-0760	CH06-11056	P13-6658	CH21-17070
P10-9206	SC-12270	P11-9235	CH-12273	P12-2133	ST09-12265	P13-0761	CH06-11056	P13-6659	SC21-17075
P11-0544	CH04-11675	P11-9237	CH16-12253	P12-2155	SC10-11317	P13-0765	CH12-11389	P13-6660	SC-12252
P11-0545	CH05-11106	P11-9238	CH-12260	P12-2156	SC12-11391	P13-0771	CH-14104	P13-6824	SC-12274
P11-0554	CH10-11308	P11-9247	CH10-12224	P12-2157	SC14-12254	P13-0776	ST-12226	P13-6840	CH05-11106
P11-0555	SC10-11317	P11-9340	CH05-11106	P12-2329	CH12-11389	P13-1280	CH14-13356	P13-6989	CH-12269
P11-0556	CH12-11389	P11-9363	CH08-11288	P12-2330	CH14-12245	P13-1282	CH09-12244	P13-6990	SC-12270
P11-0557	SC12-11391	P11-9370	SC-12274	P12-2510	CH05-11106	P13-1328	CH10-11308	P13-6991	SC18-17232
P11-0558	CH14-12245	P11-9371	SC-12270	P12-2694	CH-12262	P13-1329	CH10-11308	P13-7178	CH-12268
P11-0559	SC14-12254	P11-9372	SC-12252	P12-2696	CH12-12251	P13-1333	CH-12273	P13-8133	CH-12273
P11-1065	CH-12284	P11-9373	SC14-12254	P12-2836	CH16-12253	P13-1334	SC10-12395	P13-8336	ST06-12048
P11-1098	PF-15677	P11-9374	SC12-11391	P12-2837	SC-12252	P13-1344	ST08-11316	P13-8338	CH-12247
P11-1776	SC-12274	P11-9375	SC10-11317	P12-2860	CH06-11056	P13-1346	CH06-11056	P13-8428	CH-13050
P11-2031	CH12-12251	P11-9409	CH08-11288	P12-2991	ST08-11316	P13-1350	SC10-11317	P13-8748	CH05-11106
P11-2830	CH-12262	P11-9410	ST08-11316	P12-3160	ST-14343	P13-1351	SC12-11391	P13-8751	CH-12208
P11-3179	CH-12273	P11-9538	CH06-14733	P12-3405	CH08-11288	P13-1352	SC14-12254	P13-8752	CH-12214
P11-3341	CH10-11308	P11-9576	CH-12273	P12-3412	PF-14090	P13-1394	ST08-11110	P13-8753	CH-12210
P11-3343	SC10-12395	P11-9612	CH10-11308	P12-3412	PFM-14095	P13-1399	SC-12252	P13-8845	CH-12207
P11-3501	CH-14104	P11-9613	SC10-12395	P12-3753	CH08-11288	P13-1403	CH08-11288	P13-8861	CH-12403
P11-4500	ST06-11315	P11-9648	CH06-11056	P12-3770	ST09-12265	P13-2566	CH06-11056	P13-8999	CH04-11675
P11-4506	ST06-11315	P11-9649	ST-12226	P12-4154	CH08-11003	P13-2597	CH14-12245	P14-0101	CH-12278
P11-4747	CH08-12221	P11-9674	CH08-11003	P12-4156	CH05-11106	P13-2598	SC-12252	P14-0110	CH-12235
P11-4748	CH-12275	P11-9677	SC-12274	P12-4164	CH08-12228	P13-2599	SC-12274	P14-0122	CH-16873
P11-5623	CH12-11389	P11-9693	CH-12262	P12-4173	CH08-11288	P13-2601	CH14-12245	P14-0123	CH-12385
P11-6501	CH12-11389	P11-9696	CH12-12251	P12-4176	CH12-12251	P13-2604	CH12-11389	P14-0132	CH-12232
P11-6502	SC12-11391	P11-9775	CH06-11038	P12-4177	CH10-12224	P13-2605	SC12-11391	P14-0135	CH-12249
P11-6541	SC12-11391	P11-9776	CH05-11106	P12-4179	CH-12653	P13-2609	SC14-12254	P14-0136	CH-12242
P11-6570	CH-13141	P11-9778	ST09-12265	P12-4525	CH-12276	P13-2976	CH08-12243	P14-0137	CH-12212
P11-7053	CH-12260	P12-0022	CH09-12244	P12-4526	SC10-11317	P13-2977	CH05-11106	P14-0185	CH-12238
P11-7089	CH-12282	P12-0057	CH-12272	P12-6334	CH10-11308	P13-3138	SC10-12395	P14-0186	CH-12231
P11-7092	CH-12282	P12-0058	CH-12271	P12-6343	SC12-11391	P13-3140	CH10-11308	P14-0187	CH-12386
P11-7433	CH-12269	P12-0113	CH05-11106	P12-6984	ST-12226	P13-3149	CH16-12253	P14-0237	CH21-17070
P11-7435	CH-12273	P12-0281	CH05-11467	P12-7128	CH08-11003	P13-3152	SC-12252	P14-0537	CH04-11675
P11-7437	CH14-12245	P12-0307	ST-13410	P12-7532	CH-12276	P13-3320	CH12-11389	P14-0633	CH-12246
P11-7439	CH12-11389	P12-0591	CH09-12244	P12-7784	CH08-12228	P13-3321	CH14-12245	P141628	CH14-12245
P11-7441	CH-12266	P12-0841	CH16-12253	P12-7787	ST08-12229	P13-3322	SC12-11391	P14-1629	SC14-12254
P11-7443	CH16-12253	P12-0842	CH14-12245	P12-8047	CH18-17230	P13-3323	SC14-12254	P14-1770	CH-12867
P11-7580	CH-12273	P12-0949	ST05-14980	P12-8149	CH08-11288	P13-3525	CH10-12224	P14-2012	CH-12260
P11-7781	SC21-17075	P12-1200	CH05-11106	P12-8406	SC18-17232	P13-3546	CH05-11106	P14-2115	CH-12275
P11-7782	CH21-17070	P12-1240	CH04-11675	P12-8407	CH18-17230	P13-4009	CH-12209	P142141	CH-12386
P11-7939	CH12-11389	P12-1414	ST-12226	P12-8408	SC18-17232	P13-4020	CH-12212	P142145	CH-12216
P11-8159	CH10-12224	P12-1415	ST06-11315	P12-8517	SC-12274	P13-4743	CH-12268	P142146	CH-12215
P11-8160	CH08-11003	P12-1642	CH06-11056	P12-8531	ST08-11110	P13-6173	CH-12282	P14-2742	CH-12269
P11-8166	CH10-11308	P12-1643	ST-12226	P12-8846	CH-12215	P13-6256	CH10-11308	P14-2743	CH-12273
P11-8211	CH14-13356	P12-1673	CH10-11308	P12-8852	CH-12216	P13-6257	CH08-11003	P14-2744	CH12-11389
P11-8216	SC14-13357	P12-1674	CH12-11389	P12-8952	CH-12268	P13-6259	CH06-11056	P14-2746	SC21-17075

Cross Reference by Manufacturer



MFRS. NO.	OUR NO.	MFRS. NO.	OUR NO.	MFRS. NO.	OUR NO.	MFRS. NO.	OUR NO.	MFRS. NO.	OUR NO.
P14-2747	CH21-17070	P15-1771	CH14-12245	P15-5698	SC18-17232	P18-2044	CH-12269	P53-2008	ST-13527
P14-2750	SC-12274	P15-1774	CH08-11288	P15-8182	CH-12385	P18-2045	CH10-12224	P53-2012	CH-12980
P14-2751	SC-12270	P15-1775	CH06-14733	P15-8557	CH08-11288	P18-2046	CH14-12245	P53-2021	CH-12209
P14-2752	SC-12252	P15-1776	CH05-11467	P15-8661	CH-13157	P18-2050	CH05-11106	P53-3332	CH-12716
P14-2753	SC12-11391	P15-1777	CH18-17230	P15-8662	CH-13156	P18-2052	CH06-11038	P53-5089	PF-15686
P14-2755	ST09-12265	P15-1874	CH-12264	P15-8663	CH-13150	P18-2054	CH08-11003	P53-5332	ST07-14270
P14-2756	CH09-12244	P15-1903	SC14-12254	P15-8669	CH-13141	P18-2062	CH06-14733	P53-5362	CH-12716
P14-3316	CH12-11389	P15-1904	CH12-12251	P15-8671	CH-12272	P18-2063	CH09-12244	P53-7876	CH-16689
P14-3571	CH04-11675	P15-1905	ST09-12265	P160558	CH08-12243	P18-2064	CH10-11308	P53-8494	CH05-15887
P14-5444	CH05-11106	P15-1906	CH09-12244	P17-0180	CH06-11880	P18-2072	CH05-11467	P53-9465	CH-12213
P14-5520	CH-12269	P15-1910	SC10-11317	P-17064	CH-12262	P18-2090	CH-12276	P53-9466	CH-12091
P14-5521	CH-12273	P15-1915	CH-12260	P18-1007	CH-12268	P18-2092	CH-12286	P55-5089	PF-15686
P14-5655	CH04-11675	P15-1917	SC-12274	P18-1033	CH-12262	P182173	CH14-12245	P77-0027	CH-12283
P14-5695	SC-12274	P15-1918	CH-12273	P18-1034	CH12-11389	P18-4033	CH-12262	P77-0035	CH-11211
P14-5700	CH-12798	P15-1921	CH14-12245	P18-1035	CH12-12251	P18-4034	CH12-11389	P77-0145	CH06-11056
P14-5895	CH09-12244	P15-1951	CH-12234	P18-1036	CH-12260	P18-4035	CH12-12251	P77-0180	CH06-11880
P14-8380	CH12-11389	P15-1966	SC18-17232	P18-1041	CH-12273	P18-4036	CH-12260	P77-0181	ST06-12048
P14-8381	CH10-11308	P15-2038	CH-12385	P18-1042	CH18-17230	P18-4041	CH-12273	P77-0197	CH08-11935
P14-8383	CH05-11106	P15-2302	ST05-14980	P18-1044	CH-12269	P18-4042	CH18-17230	P77-0198	ST08-11316
P14-8384	ST09-12265	P15-2576	CH14-12245	P18-1046	CH14-12245	P18-4044	CH-12269	P77-0221	CH-12752
P14-8821	CH12-11389	P15-2583	CH14-12245	P18-1050	CH05-11106	P18-4046	CH14-12245	P77-0227	CH-12660
P14-8823	ST08-12229	P15-2643	CH05-11106	P18-1059	CH08-11288	P18-5002	CH16-12253	P77-0234	CH-12250
P14-8967	CH05-11467	P15-2644	CH08-11288	P18-1062	CH06-14733	P18-5034	CH12-11389	P77-0234	CH-16874
P14-8969	CH05-11106	P15-2647	CH04-11675	P18-1063	CH09-12244	P18-5039	CH-12266	P77-0364	CH-13074
P14-8970	CH04-11675	P15-2648	CH12-12251	P18-1064	CH10-11308	P18-5040	CH21-17070	P77-0367	CH08-11942
P15-0061	CH14-12245	P15-2652	CH09-12244	P18-1072	CH05-11467	P18-5041	CH-12273	P77-0373	CH05-11106
P15-0135	PF-14090	P15-2654	CH06-14733	P18-1088	CH-12386	P18-5042	CH18-17230	P77-0382	CH-13050
P15-0135	PFM-14095	P15-2655	CH10-11308	P18-1089	CH-12231	P18-5044	CH-12269	P77-0414	CH-12276
P15-0610	CH08-11288	P15-2656	CH05-11467	P18-1090	CH-12276	P18-5046	CH14-12245	P77-0494	SC10-11317
P15-0611	CH06-14733	P15-2659	CH12-11389	P18-1092	CH-12286	P-18706	CH-12210	P77-0495	ST09-12265
P15-0612	CH09-12244	P15-2712	ST-13410	P18-1102	CH-12210	P-18709	CH-12208	P77-0504	CH-12248
P15-0906	CH-12210	P15-2714	ST09-12265	P18-1103	CH-12208	P-19159	CH-12214	P77-0520	SC10-11317
P15-0907	CH-12208	P15-2716	SC12-11391	P18-1104	CH-12214	P-19167	CH-12207	P77-0576	CH-12282
P15-0908	CH-12214	P15-2718	SC10-11317	P18-1105	CH-12207	P52-2450	CH-12605	P77-0589	CH08-17365
P15-0909	CH-12207	P15-3336	CH-12266	P18-1116	CH-12260	P52-2839	CH-12242	P77-0666	CH12-11343
P15-0921	CH-13141	P15-3351	CH12-12251	P18-1119	CH-12271	P52-4382	PF-15683	P77-0666	CH-13477
P15-0924	CH-12272	P15-3352	CH12-11389	P18-1126	CH-12403	P52-5027	CH04-11675	P77-0677	CH-12794
P15-0925	CH-12271	P15-3353	SC12-11391	P18-1137	CH-12235	P52-6504	CH-12867	P77-0709	CH-15300
P15-0933	CH-13157	P15-3354	CH14-12245	P18-1173	CH14-12245	P52-6660	CH06-14733	P77-0734	CH-12798
P15-0934	CH-13156	P15-3355	CH10-11308	P18-1184	CH-12235	P52-6755	CH10-11308	P77-0736	SC14-12254
P15-0935	CH-13150	P15-3356	SC14-12254	P18-1186	CH-11020	P52-7829	CH-12289	P77-0739	CH14-12245
P15-1135	CH18-17230	P15-3358	CH04-11675	P18-1206	CH-12091	P52-8221	CH-12206	P77-0800	CH-12790
P15-1145	CH08-11288	P15-3359	CH05-11106	P18-2002	CH16-12253	P52-8225	PF-15684	P77-0833	CH10-12390
P15-1156	CH12-12251	P15-3361	SC10-11317	P18-2034	CH12-11389	P52-9556	ST-13410	P77-0833	CH10-14455
P15-1157	CH14-12245	P15-3386	CH14-13356	P18-2036	CH-12260	P52-9596	CH16-12253	P77-0834	CH-12345
P15-1179	CH06-14733	P15-4003	ST-14343	P18-2039	CH-12266	P53-1034	ST-13531	P77-0954	CH-14237
P15-1323	CH05-11106	P15-4631	ST-14343	P18-2040	CH21-17070	P53-2003	ST-13529	P77-1004	CH-14104
P15-1596	CH-12273	P15-4632	CH08-11288	P18-2041	CH-12273	P53-2006	ST-16488	P77-1006	CH-12275
P15-1757	ST06-11315	P15-5334	ST08-11316	P18-2042	CH18-17230	P53-2007	ST-13531	P77-1174	SC-15604

Cross Reference by Manufacturer



MFRS. NO.	OUR NO.	MFRS. NO.	OUR NO.	MFRS. NO.	OUR NO.	MFRS. NO.	OUR NO.	MFRS. NO.	OUR NO.
P77-1504	CH-12276	P77-2529	CH08-11942	P77-5370	ST-13529	P78-0523	ST09-16731	P815851	CH05-11106
P77-1507	CH-16873	P77-2530	CH-12790	P77-5371	ST-13528	P78-0622	CH-16523	P81-5852	CH05-11106
P77-1508	CH-12242	P77-2531	CH-12345	P77-5372	ST-13531	P78-0647	CH07-14074	P81-5861	CH06-11038
P77-1509	CH-12238	P77-2532	SC10-11317	P77-5457	ST08-14829	P78-0910	CH-16689	P81-5880	CH08-11288
P77-1510	CH-12246	P77-2534	CH-14104	P77-5500	SC-15604	P78-1039	CH10-15371	P81-5881	CH08-11288
P77-1511	CH10-11117	P77-2545	CH10-11308	P77-5631	CH05-14409	P78-1741	CH-16922	P82-1575	CH05-15887
P77-1515	CH-12752	P77-2549	CH06-11880	P77-5687	CH-12770	P78-1911	CH08-14410	P82-2143	SC12-11391
P77-1516	CH-12248	P77-2550	CH08-11935	P77-5704	ST-16879	P78-2099	CH-16294	P82-2144	SC14-12254
P77-1519	CH-12282	P77-2552	CH-13074	P77-5739	CH-12386	P78-4015	PF-15700	P82-2686	CH04-14412
P77-1520	CH-12794	P77-2553	CH08-14835	P77-5792	CH-12231	P78-4574	PF-15701	P82-2768	CH06-16050
P77-1521	CH-15300	P77-2555	CH10-12390	P77-5803	CH-12507	P80-1843	CH10-11308	P82-2769	ST06-16054
P77-1522	CH-12798	P77-2555	CH10-14455	P77-5804	CH-15304	P80-2507	SC-12252	P82-2858	ST05-16108
P77-1527	CH12-11343	P77-2564	CH08-12228	P77-5843	CH-13763	P80-2781	SC14-12254	P82-3333	ST08-14413
P77-1527	CH-13477	P77-2565	CH-13075	P77-6260	CH-12825	P80-3914	CH14-12245	P82-6982	SC12-11391
P77-1528	CH-12250	P77-2578	CH05-14409	P77-6284	CH10-12390	P80-3915	CH14-12245	P82-7653	CH-17490
P77-1528	CH-16874	P77-2579	CH07-14074	P77-6284	CH10-14455	P80-4874	SC14-12254	P82-7655	CH-15475
P77-1529	CH08-11942	P77-2580	CH08-14410	P77-6358	CH06-11941	P80-6412	ST-14343	P82-8889	CH08-17365
P77-1530	CH-12790	P77-2581	CH-15673	P77-6565	ST06-11109	P80-6426	CH14-12245	P82-9332	ST07-14270
P77-1531	CH-12345	P77-2585	CH-15294	P77-6694	ST-13530	P80-6660	SC-12252	P82-9333	ST08-17366
P77-1532	CH-14237	P77-2586	CH-15565	P77-6695	ST-13531	P80-6766	SC14-12254	P90-0152	CH-12231
P77-1534	CH-14104	P77-2587	CH-14154	P77-6696	ST-13527	P80-6767	CH14-12245	P90-0250	CH-12272
P77-1537	CH-12653	P77-2597	CH-13473	P77-6697	ST-13529	P80-7219	CH14-12245	P90-0349	CH-12289
P77-1545	CH10-11308	P77-3521	CH-12282	P77-6745	CH-16523	P80-7335	SC14-13357	P90-0433	CH08-11288
P77-1549	CH06-11880	P77-3605	CH-13270	P77-6895	ST-14787	P80-7336	CH14-13356	P90-0434	ST06-11315
P77-1550	CH08-11935	P77-4501	CH-15565	P77-7279	CH-16689	P80-7628	ST-12226	P90-0635	CH-12225
P77-1551	CH-12660	P77-4502	CH12-11389	P77-7408	SC-16290	P80-7641	CH06-11056	P90-0685	CH-12225
P77-1552	CH-13074	P77-4504	CH-12276	P77-7409	CH-14888	P80-9315	CH14-12245	P90-0715	CH14-12245
P77-1553	CH08-14835	P77-4505	CH-12269	P77-7414	SC-16290	P81-1004	CH10-11308	P90-0717	SC14-12254
P77-1555	CH10-12390	P77-4509	CH08-11935	P77-7523	ST-16488	P81-1200	CH12-12251	P90-0763	CH-12272
P77-1555	CH10-14455	P77-4518	CH14-12245	P77-7524	ST-16487	P81-1203	CH12-11389	P90-0799	CH-12247
P77-1556	CH-14386	P77-4521	CH-12282	P77-7551	ST-13528	P81-1213	CH12-12251	P90-0830	CH10-11308
P77-1557	CH-12225	P77-4524	CH14-12245	P77-7579	CH-14900	P81-1413	CH14-12245	P90-0831	SC10-11317
P77-1558	CH-12278	P77-4538	CH-12798	P77-7638	CH-16928	P81-1500	CH05-11106	P90-0832	CH-12604
P77-1561	CH-12385	P77-4550	CH08-11935	P77-7639	ST10-15380	P81-2004	CH10-12224	P90-0833	CH-12605
P77-1562	CH-12275	P77-4551	CH-15304	P77-7654	CH-15475	P81-2016	CH10-11308	P90-0836	CH08-11288
P77-1563	CH-12247	P77-4552	CH-15300	P77-7655	CH-15475	P81-2204	CH12-11389	P90-0929	CH-12790
P77-1564	CH08-12228	P77-4576	CH-15294	P77-7868	CH-16294	P81-2223	CH12-11389	P90-0942	CH-12794
P77-1572	CH-13404	P77-4578	CH-13473	P77-7869	SC-16301	P81-2405	CH14-12245	P90-1512	CH-13157
P77-1575	CH-12387	P77-4583	SC14-12254	P77-7871	CH-16521	P81-2408	CH14-12245	P90-1514	CH-13156
P77-1583	CH-12247	P77-5064	CH-12507	P77-7875	SC-16522	P81-2506	CH05-11106	P90-1516	CH-13150
P77-1593	CH-12285	P77-5074	CH-12507	P77-8131	ST-16876	P81-2513	CH-12770	P90-1524	CH-12208
P77-1594	CH-12091	P77-5298	ST05-14402	P77-8335	CH-14896	P81-2600	CH16-12253	P90-1526	CH-12214
P77-2504	CH-12276	P77-5300	ST07-14270	P77-8336	CH-14902	P81-2602	CH16-12253	P90-1528	CH-12207
P77-2519	CH-12282	P77-5302	ST08-14413	P77-8404	CH-12397	P81-4539	SC12-11391	P90-1530	CH-12271
P77-2520	CH-12794	P77-5339	SC-15681	P77-8441	CH-14107	P81-4723	CH-12770	P90-1546	CH-12210
P77-2521	CH-15300	P77-5366	ST-16488	P77-8472	CH-12236	P81-5267	CH-12739	P90-1550	CH-13141
P77-2522	CH-12798	P77-5367	ST-16487	P77-8509	CH-14387	P81-5288	CH08-11935	P90-3914	CH14-12245
P77-2527	CH12-11343	P77-5368	ST-13530	P78-0272	CH-13185	P81-5840	CH04-11675	R80-0969	SC14-12254
P77-2527	CH-13477	P77-5369	ST-13527	P78-0522	CH09-16729	P81-5850	CH05-11106	R80-4200	CH-12798

Cross Reference by Manufacturer



MFRS. NO.	OUR NO.	MFRS. NO.	OUR NO.	MFRS. NO.	OUR NO.	MFRS. NO.	OUR NO.	MFRS. NO.	OUR NO.
R80-4201	CH14-12245	SMP77-1527	CH-13477	XLP18-4046	CH14-12245	EBA-15-0012	CH-12268	FHG-12-0062	CH12-11389
R80-4300	CH12-11389	SMP77-1528	CH-12250	XLP77-2504	CH-12276	EBB-12-0070	CH-12214	FHG-12-0102	CH12-11389
R80-4301	CH14-13356	SMP77-1528	CH-16874	XLP77-2519	CH-12282	ECG-13-0005	CH-12268	FHG-12-0105	CH12-11389
R80-4523	ST-14343	SMP77-1529	CH08-11942	XLP77-2520	CH-12794	ECG-15-0001	CH-12282	FHG-12-0106	CH12-11389
R80-4523	ST06-11109	SMP77-1530	CH-12790	XLP77-2521	CH-15300	ECG-15-0010	CH-12282	FHG-12-0134	CH12-11389
R80-4570	ST09-12265	SMP77-1531	CH-12345	XLP77-2522	CH-12798	FHG-05-2558	CH05-11467	FHG-12-0135	CH12-11389
SMP18-1007	CH-12268	SMP77-1532	SC10-11317	XLP77-2527	CH12-11343	FHG-05-2559	CH05-11467	FHG-12-0152	SC10-11317
SMP18-1033	CH-12262	SMP77-1534	CH-14104	XLP77-2527	CH-13477	FHG-05-2560	CH05-11467	FHG-12-0154	SC12-11391
SMP18-1034	CH12-11389	SMP77-1537	CH-12653	XLP77-2529	CH08-11942	FHG-05-2561	CH05-11467	FHG-14-0023	CH14-12245
SMP18-1035	CH12-12251	SMP77-1545	CH10-11308	XLP77-2530	CH-12790	FHG-05-2562	CH05-11467	FHG-14-0055	CH14-12245
SMP18-1036	CH-12260	SMP77-1549	CH06-11880	XLP77-2531	CH-12345	FHG-05-2567	CH05-12222	FHG-14-0065	CH14-12245
SMP18-1041	CH-12273	SMP77-1550	CH08-11935	XLP77-2532	SC10-11317	FHG-05-2594	CH05-11106	FHG-14-0103	CH14-12245
SMP18-1042	CH18-17230	SMP77-1551	CH-12660	XLP77-2534	CH-14104	FHG-05-2595	CH05-11106	FHG-14-0118	CH14-12245
SMP18-1044	CH-12269	SMP77-1552	CH-13074	XLP77-2545	CH10-11308	FHG-05-2599	CH05-11106	FHG-14-0121	CH14-12245
SMP18-1046	CH14-12245	SMP77-1553	CH-13270	XLP77-2549	CH06-11880	FHG-06-5104	CH06-14733	FHG-14-0152	SC14-12254
SMP18-1050	CH05-11106	SMP77-1555	CH10-12390	XLP77-2550	CH08-11935	FHG-06-5115	CH06-14733	FHG-14-0164	CH14-12245
SMP18-1059	CH08-11288	SMP77-1555	CH10-14455	XLP77-2552	CH-13074	FHG-06-5124	CH06-11295	FHG-14-0194	CH14-12245
SMP18-1062	CH06-14733	SMP77-1562	CH-12275	XLP77-2553	CH08-14835	FHG-06-5137	CH06-11295	FHG-14-0208	CH14-12245
SMP18-1063	CH09-12244	SMP77-1563	CH-12247	XLP77-2555	CH10-12390	FHG-06-5140	ST-12226	FHG-16-0225	CH16-12253
SMP18-1064	CH10-11308	SMP77-1564	CH-12385	XLP77-2555	CH10-14455	FHG-06-5152	CH06-11056	FHG-16-0254	CH16-12253
SMP18-1072	CH05-11467	SMP77-1572	CH-13404	XLP77-2564	CH08-12228	FHG-06-5155	CH06-11295	FWA-05-2526	CH05-11106
SMP18-1088	CH-12386	SMP77-1594	CH-12091	XLP77-2565	CH-13075	FHG-06-5175	CH06-11056	FWA-05-2527	CH05-11106
SMP18-1089	CH-12231	SMP77-3521	CH-12282	XLP77-2586	CH-15565	FHG-06-5181	CH06-11056	FWA-05-2542	CH05-11106
SMP18-1090	CH-12276	XLP18-2002	CH16-12253	XLP77-2587	CH-12345	FHG-06-5191	CH06-11056	FWA-05-2551	CH05-11106
SMP18-1092	CH-12286	XLP18-2034	CH12-11389	XLP77-2597	CH-13473	FHG-06-5199	CH06-11056	FWA-05-2552	CH05-11106
SMP18-1102	CH-12210	XLP18-2036	CH-12260	XLP77-4501	CH-15565	FHG-06-5205	ST06-11315	FWA-05-2563	CH05-11106
SMP18-1103	CH-12208	XLP18-2039	CH-12266	XLP77-4521	CH-12282	FHG-06-5207	ST-12226	FWA-08-0054	CH08-12243
SMP18-1104	CH-12214	XLP18-2040	CH21-17070	XLP77-4524	CH14-12245	FHG-06-5211	CH06-11056	FWA-08-0055	CH08-12243
SMP18-1105	CH-12207	XLP18-2041	CH-12273	XLP77-4552	CH-15300	FHG-08-0195	CH08-11288	FWA-08-0517	CH08-12221
SMP18-1116	CH-12260	XLP18-2042	CH18-17230	XLP77-4576	CH-15294	FHG-08-0205	CH08-11288	FWA-08-0518	CH08-12221
SMP18-1119	CH-12271	XLP18-2044	CH-12269	DONALDSON HOUSING		FHG-08-0233	CH08-11288	FWA-08-0519	CH08-12221
SMP18-1126	CH-12403	XLP18-2045	CH10-12224	EBA-13-0017	CH-12268	FHG-08-0270	CH08-11288	FWA-08-0520	CH08-12221
SMP18-1137	CH-12235	XLP18-2046	CH14-12245	EBA-13-0018	CH-12268	FHG-08-0281	CH08-12228	FWA-09-3304	CH-12275
SMP18-1184	CH-12235	XLP18-2050	CH05-11106	EBA-13-0023	CH-12268	FHG-08-0306	CH08-11288	FWA-10-0002	CH10-12224
SMP18-1186	CH-11020	XLP18-2052	CH06-11038	EBA-13-0024	CH-12268	FHG-08-0307	CH08-11288	FWA-10-0012	CH10-12224
SMP18-1206	CH-12091	XLP18-2054	CH08-11003	EBA-13-0025	CH-12268	FHG-08-0310	ST08-11316	FWA-10-0051	CH10-12224
SMP77-1174	SC-15604	XLP18-2062	CH06-14733	EBA-13-0026	CH-12268	FHG-09-0021	CH09-12244	FWA-10-0064	CH10-12224
SMP77-1504	CH-12276	XLP18-2063	CH09-12244	EBA-13-0027	CH-12268	FHG-09-0024	CH09-12244	FWA-10-0065	CH10-12224
SMP77-1507	CH-16873	XLP18-2064	CH10-11308	EBA-13-0028	CH-12268	FHG-09-0025	CH09-12244	FWA-12-0003	CH12-12251
SMP77-1508	CH-12242	XLP18-2072	CH05-11467	EBA-13-0034	CH-12268	FHG-09-0031	ST09-12265	FWA-12-0008	CH12-12251
SMP77-1509	CH-12238	XLP18-2090	CH-12276	EBA-13-0035	CH-12268	FHG-09-0046	ST09-12265	FWA-12-0024	CH12-12251
SMP77-1510	CH-12246	XLP18-2092	CH-12286	EBA-13-0045	CH-12268	FHG-09-0053	ST09-12265	FWA-12-0025	CH12-12251
SMP77-1515	CH-12752	XLP18-4033	CH-12262	EBA-13-0049	CH-12268	FHG-09-0081	CH09-12244	FWA-12-0035	CH12-12251
SMP77-1516	CH-12248	XLP18-4034	CH12-11389	EBA-13-0051	CH-12268	FHG-10-0028	CH10-11308	FWA-12-0036	CH12-12251
SMP771519	CH-12282	XLP18-4035	CH12-12251	EBA-13-0054	CH-12268	FHG-10-0035	CH10-11308	FWA-12-0044	CH12-12251
SMP77-1520	CH-12794	XLP18-4036	CH-12260	EBA-13-0056	CH-12268	FHG-10-0044	CH10-11308	FWA-12-0051	CH12-12251
SMP77-1521	CH-15300	XLP18-4041	CH-12273	EBA-13-0064	CH-12268	FHG-10-0123	CH10-11308	FWA-12-0053	CH12-12251
SMP77-1522	CH-12798	XLP18-4042	CH18-17230	EBA-13-5000	CH-12268	FHG-12-0012	CH12-11389	FWA-12-0054	CH12-12251
SMP77-1527	CH12-11343	XLP18-4044	CH-12269	EBA-15-0004	CH-12282	FHG-12-0037	CH12-11389	FWA-12-0061	CH12-12251

Cross Reference by Manufacturer



MFRS. NO.	OUR NO.	MFRS. NO.	OUR NO.	MFRS. NO.	OUR NO.	MFRS. NO.	OUR NO.	MFRS. NO.	OUR NO.
FWA-12-0063	CH12-12251	FWG-12-0061	CH12-12251	SDG-12-0067	CH-12262	4930515	CH-12247	ECOMAT	
FWA-12-0075	CH12-12251	FWG-12-0063	CH12-12251	SDG-12-0110	CH-12262	4930549	ST09-12265	Y1500001	ST06-12048
FWA-12-0082	CH12-12251	FWG-12-0084	CH12-12251	SDG-12-0140	CH-12262	4930550	ST-13531	EDER	
FWA-12-0084	CH12-12251	FWG-12-0109	CH12-12251	SDG-12-0150	CH-12262	4930646	CH05-11106	900136	SC10-11317
FWA-12-0085	CH12-12251	FWG-12-0111	CH12-12251	SDG-12-0211	CH-12262	4930684	CH-12397	900137	CH-12276
FWA-12-0091	CH12-12251	FWG-14-0028	CH14-12245	SDG-12-0240	CH-12262	DRESSER/GALION			
FWA-12-0092	CH12-12251	FWG-14-0052	CH14-12245	SRG-20-0031	SC21-17075	103259	SC14-12254	EICHER	
FWA-12-0094	CH12-12251	FWG-14-0118	CH14-12245	STG-14-0338	CH-12273	106576	CH10-11308	908946-M4	CH-12209
FWA-12-0098	CH12-12251	KAX-00-0171	CH04-11675	DONIT			EIMCO		
FWD-04-2501	CH04-11675	KAX-00-0372	CH-12262	4130115U	CH10-11308	106579	SC10-11317	JVA003	CH-12262
FWG-04-2501	CH04-11675	KAX-00-0486	CH-12260	413033	CH-11348	84371	CH10-12224	JVA3	CH-12262
FWG-04-2503	CH04-11675	KAX-00-0510	CH05-11106	413042	CH-12235	99737	CH12-11389	JVM10	CH-12262
FWG-04-2504	CH04-11675	KAX-00-0514	SC12-11391	413082	CH-12386	99739	SC12-11391	JVM3	CH-12262
FWG-04-2529	CH04-11675	KAX-00-2079	CH12-11389	413086	CH-12091	DRILTECH			
FWG-05-2509	CH05-11106	KAX-00-2371	CH10-12224	413090	CH16-12253	001036061	CH21-17070	JVM5	CH-12262
FWG-05-2510	CH05-11106	KAX-00-2416	CH12-11389	413095	CH-12234	001036-53	SC21-17075	ELGIN SWEEPER	
FWG-05-2511	CH05-11106	KAX-00-2459	CH12-11389	413095B	CH-12242	001036-61	CH21-17070	7072938	ST06-11315
FWG-05-2512	CH05-11106	KAX-00-2594	CH14-12245	413098	CH-12385	002004-58	CH-12266	A-11569	CH08-12243
FWG-05-2513	CH05-11106	KAX-00-2595	CH16-12253	4930052	CH-12660	ENUMCLAW			
FWG-05-2516	CH05-11106	KAX-00-3845	CH14-12245	4930060	CH08-11288	208433	CH08-12243	17580	CH08-12243
FWG-05-2518	CH05-11106	KYX-00-0460	CH-13157	4930096	CH-12248	221106	CH10-12224	ERICKSON	
FWG-05-2522	CH05-11106	KYX-00-0461	CH-13156	4930098	CH-12249	505694	CH08-12243	35176	CH05-11106
FWG-05-2523	CH05-11106	KYX-00-0462	CH-12210	4930140	CH-12285	5512140	CH05-11467	35178	CH05-11106
FWG-05-2525	CH05-12222	KYX-00-2574	CH-12260	4930142	SC10-11317	609421	CH12-11389	35508	CH05-11106
FWG-05-2527	CH05-11106	KYX-00-3507	SC10-11317	4930186	CH-12206	A43656	CH-12269	35767	CH05-11106
FWG-05-2528	CH05-11106	SBG-12-0005	CH-12262	493022	CH12-12251	A436576	CH-12269	EUCLID	
FWG-05-2530	CH05-11106	SBG-12-0017	CH-12262	4930309	CH-12278	DROTT			
FWG-05-2539	CH05-11106	SBG-12-0022	CH-12262	4930324	CH-12953	208433	CH08-12243	4001135	CH-12269
FWG-05-2545	CH05-11106	SBG-12-0032	CH-12262	4930363	ST-13527	221106	CH10-12224	4001155	SC-12270
FWG-05-2563	CH04-11675	SBG-12-0035	CH-12262	4930367	CH-12209	505694	CH08-12243	4001156	CH-12269
FWG-05-2575	CH05-11106	SBG-12-0250	CH-12262	4930372	ST-13530	5512140	CH05-11467	4003987	SC-12274
FWG-05-2579	CH05-11106	SBG-12-0251	CH-12262	4930384	SC12-11391	599307	ST09-12265	4012356	CH-12266
FWG-05-2597	CH05-11106	SBG-12-0252	CH-12262	4930387	CH-12225	499309	CH05-11106	4012358	SC-12270
FWG-05-2619	CH05-11106	SBG-12-0253	CH-12262	4930393	CH-12980	499345	CH08-11288	4012359	CH-12269
FWG-08-0035	CH08-12221	SBG-12-0257	CH-12262	4930405	CH06-11295	499346	ST08-11316	4012360	SC-12274
FWG-08-0044	CH08-11288	SBG-12-0258	CH-12262	4930409	CH-12250	499514	SC-12274	4012361	CH-12273
FWG-08-0228	CH08-12243	SBG-12-0259	CH-12262	4930409	CH-16874	499553	CH10-11308	4015860	CH-12260
FWG-08-0229	CH08-12243	SBG-16-0024	CH-12260	4930432	CH06-11056	814256	SC10-11317	4058189	SC10-11317
FWG-08-0239	CH08-12221	SBG-16-0031	CH-12260	4930436	CH14-12245	814257	CH10-11308	81096473	CH-12286
FWG-08-0276	CH08-11003	SBG-16-0035	CH-12260	4930439	SC14-12254	902199	ST-14787	9028234	CH-12262
FWG-09-0071	CH-14104	SBG-16-0059	CH-12260	4930440	ST-12226	E.R.F.			
FWG-10-0007	SC12-11391	SBG-16-0113	CH-12260	4930449	CH-12231	098776-8	CH10-12390	9028636	CH-12262
FWG-10-0038	CH10-12224	SBG-16-0121	CH-12260	4930487	ST-13529	098776-8	CH10-14455	903053	CH-12262
FWG-10-0084	CH09-12244	SBG-16-0124	CH-12260	4930497	CH12-11389	131896/5	CH-12242	9030537	CH-12262
FWG-10-0086	CH10-12224	SBG-16-0350	CH-12260	4930487	ST-13529	30633	CH-12262	9030854	CH-12260
FWG-12-0015	CH12-12251	SBG-16-0351	CH-12260	4930501	CH-12208	33664	CH12-11389	9030894	CH12-12251
FWG-12-0024	CH12-12251	SBG-16-0354	CH-12260	4930506	CH-12236	39134	CH14-12245	9034529	CH-12273
FWG-12-0034	CH12-11389	SBG-16-0355	CH-12260	4930509	CH09-12244	94278-6	SC-12252	9035368	SC-12274
FWG-12-0059	CH12-12251	SBG-16-0359	CH-12260	4930511	CH09-12244	94279-2	CH16-12253	9035428	SC-12274
				4930513	CH-12246	94304-2	CH-13050	9035866	CH-12266
						99131/2	CH-12235	9035988	CH-12266
								9036278	SC-12274

Cross Reference by Manufacturer



MFRS. NO.	OUR NO.	MFRS. NO.	OUR NO.	MFRS. NO.	OUR NO.	MFRS. NO.	OUR NO.	MFRS. NO.	OUR NO.
9037346	SC-12274	1210602017700	CH-12231	0746-444	CH-12242	9746-444	CH-12242	FL-6194	CH-12208
9038349	SC21-17075	1210702019500	CH-12385	0746-547	SC-12270	FDI		FL-6195	CH-13157
9038350	CH21-17070	1210702033400	CH-12242	0746-554	ST08-11316	AFK-575	PF-15683	FL-6200	CH-12209
9038407	CH-12269	1210702033500	ST-13527	0746-555	CH08-11288	FENDT		FL-6202	CH-12210
9038408	SC-12270	1212302023600	ST-13531	0746-712	ST-13531	F135201090020	CH-12397	FL-6203	CH-13150
9038895	CH-12262	8121918027400	ST-13531	0746-713	CH21-17070	F135203092010	CH-12091	FL-6276	CH-13156
9038898	CH12-12251	FAI		0746-714	SC21-17075	F178200090010	CH-12231	FL-6277	CH-12214
9038899	CH-12273	848100069	CH06-11880	0746-718	SC-12274	F178200090020	ST-16487	FL-6278	CH-12215
9038902	CH-12260	848101065	CH08-11288	0746-725	CH-12231	F178810140010	PF-15688	FL-6279	CH-12216
9049489	SC-12274	848101104	ST08-11316	0746-910	CH-12397	F182200090010	CH-12386	FL-6304	CH-12091
9049490	SC-12252	848101113	CH05-11555	0746-911	CH-16873	F184200090010	CH-12386	FL-6324A	CH-12204
9053258	SC18-17232	848101114	CH05-11106	0746-916	CH14-12245	F184200090040	ST-13530	FL-6411	CH05-12222
9059564	CH18-17230	848101116	ST05-11618	0746-928	CH-12278	F184230090050	CH-12385	FL-6412	CH06-11295
9059575	CH-12276	848101155	CH08-11288	0746-931	ST09-12265	F184230090100	ST-13531	FL-6413	ST06-11315
9059577	CH-12286	P26510192	CH05-11106	0747-082	CH18-17230	F186200091010	CH-12980	FL-6417	CH-12386
9065371	SC-12274	P26510214	CH08-11288	0747-083	SC18-17232	F198200090010	CH-12386	FL-6418	ST08-11316
9191704	CH-12262	YMR000060	CH05-11106	0747-092	SC10-11317	F198810140010	PF-15688	FL-6421	CH04-11675
9206065	CH-12260	YMR000463	CH05-11106	0747-093	CH-12276	F205200091010	ST-16488	FL-6423	CH10-11308
920624	CH-12262	FAIRBANKS - MORSE		117-0781	CH-12235	F278201090020	CH-12285	FL-6424	SC10-11317
9218797	CH-12260	16006108	CH05-11106	1416433	CH-12242	F280200090030	ST-13527	FL-6438	CH-12225
9240849	SC-12274	16006114	CH05-11106	147-0629	CH-12385	F291200090100	CH-12235	FL-6439	ST-12226
9247127	CH-12266	FAIRMONT RAILWAY M		147-0630	ST-13531	F291200090110	ST-13529	FL-6440	CH06-11056
9247285	SC-12274	F17526	CH08-12243	147-0631	CH-12386	F345200090010	ST-16488	FL-6441	CH-13141
9249091	CH-12266	FAMEL		147-0634	ST-13530	F385202090010	CH-12242	FL-6446	CH12-11389
9377816	SC14-12254	FR-1006	ST-13529	147-0637	CH-12235	H51-5200-090-10	CH-16928	FL-6457	ST08-12229
9391941	CH06-11295	FR-1018	CH08-11288	147-0661	ST08-11316	H51-5200-090-11	ST10-15380	FLI-6181	CH-12207
9394161	CH14-12245	FR-1023	CH18-17230	147-0695	CH-12235	H716.200.090.10	CH-16928	FLI-6194	CH-12208
9395884	CH-12262	FR-1024	SC18-17232	147-0696	CH-12278	H716.200.090.11	ST10-15380	FLI-6195	CH-13157
9395885	CH-12260	FR-861	CH-12231	147-0702	CH-12242	X810270072	ST-16879	FLI-6200	CH-12209
9398482	CH14-12245	FR-865	CH-12235	147-0703	ST-13527	FENWICK		FLI-6202	CH-12210
9398483	SC14-12254	FR-868	ST-13527	147-0717	ST-13529	0009839017	ST-16487	FLI-6203	CH-13150
E62-2511	CH-12260	FR-972	CH-12232	147-0718	CH-12235	8100346	CH04-11675	FLI-6273	CH-12660
E63-2878	CH-12260	FR-983	CH-16873	147-0721	ST-13528	8100778	CH05-11106	FLI-6274	CH-12213
EXCEL		FR-985	ST-16487	147-0731	ST-16488	8101220	ST06-11109	FLI-6276	CH-13156
057448	CH05-11106	FR-986	ST-13530	147-0823	CH-12232	8103598	ST06-12048	FLI-6277	CH-12214
057455	CH05-11106	FR-987	ST-13531	2165-039	CH-12231	8104273	ST-13530	FLI-6278	CH-12215
E-ZGO CAR		FARMHAND		4134-352	CH10-11308	983 9020	ST-13531	FLI-6279	CH-12216
50133-GZ	CH04-11675	1R-2005	CH14-12245	4134-366	CH-12385	9831604	CH-12385	FLI-6304	CH-12091
A10706-G1	CH04-11675	1R-2006	SC14-12254	4134-367	ST-13531	9839012	CH-12397	FLI-6324A	CH-12204
FACET		FARYMANN		4134-368	CH-12386	9839014	CH-12231	FLI-6406	CH08-12221
3441	PF-15684	5410612	CH-12870	4134-370	ST-13530	9839015	CH-12386	FLI-6411	CH05-12222
3575	PF-15683	FAUN- FRISCH		4134-389	CH12-11389	9839016	ST-16488	FLI-6412	CH06-11295
AP3441	PF-15684	0746-232	CH12-12251	4134-403	CH-12235	9839019	CH-12285	FLI-6413	ST06-11315
FACO		0746-237	CH12-12251	4134-406	CH-12242	9839331	CH05-11106	FLI-6416	CH-12385
10050	ST-14343	0746-369	CH-12385	4134-407	ST-13527	FM8104273	ST-13530	FLI-6417	CH-12386
FAHR		0746-383	CH-12386	4134-415	ST-13529	FIAAM		FLI-6418	ST08-11316
1111401910300	CH-12231	0746-385	CH-16873	4134-419	ST-13528	FL-6042	CH-12206	FLI-6421	CH04-11675
1111402030400	ST-13530	0746-389	CH-12278	4134-428	ST-16488	FL-6044	CH-11348	FLI-6423	CH10-11308
1111402030600	CH-12386	0746-395	CH-12266	4134-474	CH-12232	FL-6181	CH-12207	FLI-6424	SC10-11317

Cross Reference by Manufacturer



MFRS. NO.	OUR NO.	MFRS. NO.	OUR NO.	MFRS. NO.	OUR NO.	MFRS. NO.	OUR NO.	MFRS. NO.	OUR NO.
FLI-6427	CH05-11106	FLI-6604	CH-14334	76040385	SC14-12254	1901902	CH14-12245	70244570	SC12-11391
FLI-6435	CH08-11288	FLI-6613	CH-12276	76040386	CH-12266	1902129	CH-12278	70247060	CH04-11675
FLI-6438	CH-12225	FLI-6619	CH-12278	76547841	CH06-16050	1909116	CH08-12228	70250699	CH05-11106
FLI-6439	ST-12226	FLI-6620	CH08-11935	76568665	CH-12739	1909117	ST08-12229	70256395	CH09-12244
FLI-6440	CH06-11056	FLI-6622	SC10-11317	76579880	CH-12770	1909131	CH-12235	70256983	CH08-11288
FLI-6441	CH-13141	FLI-6623	CH-12282	76585406	CH04-11675	1909132	ST-13529	70257024	CH08-11288
FLI-6446	CH12-11389	FLI-6624	CH-12283	8322160	CH-12203	1909135	SC10-11317	70257029	ST08-11316
FLI-6456	CH08-12228	FLI-6627	CH-12285	8322211	CH-12217	1909138	ST-14343	70257597	CH05-11106
FLI-6457	ST08-12229	FLI-6637	CH-12286	8322212	CH-12218	1909139	CH06-11038	70264740	CH-12269
FLI-6459	CH-12231	FLI-6689	CH-14104	86512355	ST08-12229	1909957	CH08-11288	70266787	CH09-12244
FLI-6461	CH-12232	FLI-6781	CH-11789	86512356	CH08-12228	1909964	ST08-11316	70267075	CH09-12244
FLI-6466	CH-12234	FLI-6788	ST-13529	8822160	CH-12203	1930174	CH12-11343	70267931	SC10-11317
FLI-6467	CH-12235	FLI-6789	ST-13527	FIATAGRI		1930174	CH-13477	70267953	ST09-12265
FLI-6468	CH-12236	FLI-6794	CH12-11343	1930174	CH12-11343	1930604	CH-14154	70267962	SC10-11317
FLI-6471	CH-16873	FLI-6794	CH-13477	1930174	CH-13477	1930726	ST09-12265	70440155	CH06-11295
FLI-6475	CH-12238	FLI-6799	ST-16487	1930349	CH-14380	1930728	ST06-11315	70440158	ST06-11315
FLI-6491	CH-12242	FLI-6801	ST-13531	1930536	CH-13075	1930729	CH06-11295	70595601	CH-12215
FLI-6495	CH09-12244	FLI-6818	CH-12825	1930587	CH07-14865	1930740	CH-12216	70595602	CH-12215
FLI-6496	CH14-12245	FLI-6826	CH-15673	1930588	ST07-14270	1930747	CH14-12245	70595603	CH-12216
FLI-6500	CH-12246	FLI-6838	CH-14107	1930589	CH08-17365	1930751	CH10-11308	70595604	CH-12216
FLI-6501	CH-12247	FLI-6860	ST-16880	1930590	ST08-14413	1930758	CH-12215	70648734	CH14-12245
FLI-6503	CH-12248	FLI-6862	ST-16879	1930591	CH05-14409	1930765	CH08-11935	70654409	CH10-11308
FLI-6504	CH-12249	PA-7001	PF-15684	1930592	ST05-14402	1930787	CH-14386	70659387	CH16-12253
FLI-6505	CH-12250	FIAT HITACHI		1930746	SC12-11391	1930790	SC10-12395	70659533	CH14-12245
FLI-6505	CH-16874	131063680	CH-14388	1930748	SC14-12254	1930795	ST08-11316	70660360	CH12-11389
FLI-6507	CH-12980	151849148	CH08-17365	1930752	SC10-11317	1930826	CH10-12390	70660360/9	CH12-11389
FLI-6510	CH12-12251	151849149	ST08-14413	1930784	CH-12798	1930826	CH10-14455	70662477	SC14-12254
FLI-6515	SC12-11391	151849501	CH06-11255	1930786	CH-12790	2097035	CH05-11106	70662608	SC10-11317
FLI-6516	SC14-12254	151849502	SC06-11269	1930787	CH-14386	22190599	CH-12790	70662609	SC12-11391
FLI-6523	SC06-11252	1930174	CH12-11343	1930825	ST08-12229	300138019	CH-12798	70662689/9	SC10-11317
FLI-6524	CH-12491	1930174	CH-13477	71415282	CH10-12390	4021443	CH08-12243	7066432	SC10-11317
FLI-6525	CH-12485	1930602	CH-12345	71415282	CH10-14455	42015789	CH-12235	7066432	CH10-11308
FLI-6528	CH-13510	1930603	CH10-12390	FIAT-ALLIS		4788592	CH-12387	70667685	SC-12274
FLI-6529	CH-13520	1930603	CH10-14455	0239513	CH05-11106	4789056	CH05-11106	70667686	CH-12273
FLI-6546	CH08-12228	1930748	SC14-12254	0244570	SC12-11391	4841879	CH05-11106	70667690	CH-12273
FLI-6579	CH-11211	1930752	SC10-11317	0250699	CH05-11106	4861641	CH08-12243	70674967	CH-12273
FLI-6580	CH06-12258	1930787	CH-14386	0256983	CH08-11288	4907794	CH05-11106	70684732	CH10-11308
FLI-6582	CH-12260	1930824	CH08-14835	0267931	SC10-11317	4909733	CH08-12243	70684732/1	CH10-11308
FLI-6584	CH-12262	1930825	ST08-12229	0267962	SC10-11317	6626089	SC10-11317	70684733	CH12-11389
FLI-6587	CH-12264	4290940	CH06-16050	04357887	CH-12262	6626097	SC12-11391	70684734	CH14-12245
FLI-6588	ST09-12265	4971958	CH-12203	0684732	CH10-11308	684732/1	CH10-11308	71005365	CH08-12243
FLI-6589	CH-12266	4975549	CH-12203	1004421	CH08-12243	700052302	CH-12794	71007973	CH08-11288
FLI-6593	CH-12269	61583385	CH-12288	1005365	CH08-12243	700053475	ST06-12048	71007974	ST08-11316
FLI-6594	SC-12270	71405431	CH08-14835	1007973	CH08-11288	700055856	CH-12345	71010407	CH08-11288
FLI-6595	CH-12271	71406283	ST08-12229	1010407	CH08-11288	70107974	ST08-11316	71014652	CH05-11467
FLI-6596	CH-12272	71416994	SC10-12395	1140887	CH08-12243	70197588	SC-12252	71140887	CH08-12243
FLI-6599	CH-12273	71467030	CH10-12390	1140889	CH05-11106	70237395	CH-12209	71140889	CH05-11106
FLI-6600	SC-12274	71467030	CH10-14455	1183993	SC10-11317	70239513	CH05-11106	71181296	ST09-12265
FLI-6601	CH-12275	71467031	SC10-12395	1901780	CH-12277	70239518	CH05-11106	71183993	SC10-11317

Cross Reference by Manufacturer



MFRS. NO.	OUR NO.	MFRS. NO.	OUR NO.	MFRS. NO.	OUR NO.	MFRS. NO.	OUR NO.	MFRS. NO.	OUR NO.
71420350	CH-12345	77659533	CH14-12245	8011014	CH08-12243	A2338	CH-13156	FMA258K	CH08-11003
71909116	CH08-12228	77662477	SC14-12254	80110141	CH08-12243	A2359	CH14-12245	FMA258SY	ST08-11110
71909128	CH06-11056	77722126	CH12-11389	801101411	CH08-12243	A2369	CH12-11389	FMA3659S	CH-12272
71909129	ST-12226	77825060	CH09-12244	8015977	SC14-13357	A2402	CH-12385	FMA4N0015	PF-14090
71909136	CH12-11389	77980508	CH-12276	8016976	CH14-13356	A2407	SC14-12254	FMA4N0015	PFM-14095
71909140	ST-12226	78041782	CH14-12245	8322121	CH-12215	A2411	CH12-11389	FMA4N0326	CH-12271
71909141	CH06-11056	78322121	CH-12215	8322122	CH-12216	A2412	CH10-11308	FMA502	CH16-12253
71930174	CH12-11343	78322122	CH-12216	8322128	CH-12216	A2418	CH-12250	FMA502SY	SC-12252
71930174	CH-13477	78322128	CH-12216	8322129	CH-12215	A2418	CH-16874	FMA507	CH14-12245
71930175	SC10-11317	78322129	CH-12215	8322986	CH-12278	A2426	SC12-11391	FMA523	CH12-11389
72083768	SC12-11391	78332987	CH-12273	9083212	CH08-11288	A2427	CH-12386	FMA523SY	SC12-11391
72083771	CH12-11389	78721029	SC14-12254	920007502	CH10-11117	A2428	CH-12248	FMA535	CH-12273
72097035	CH05-11106	78721219	ST09-12265	920015933	CH08-11935	A2430	SC-12274	FMA535SY	SC-12274
73039681	CH12-12251	78722126	CH12-11389	92313000	CH-12273	A2431	CH-12273	FMA536	CH-12266
73042922	CH12-11389	78822161	CH-12204	9292365	CH-12397	A2432	CH-12225	FMA546	CH10-11308
73044713	CH08-12243	79011386	CH08-11288	9927506	CH-12284	A2434	CH-12242	FMA546SY	SC10-11317
7304497	CH12-12251	79011387	ST08-11316	AX-64724	CH05-11106	A2436	CH-12213	FMA563	CH-12269
73045860	CH12-12251	79022025	CH06-11056	F09917881	CH12-12251	A2437	CH-12660	FMA563SY	SC-12270
73047497	CH12-12251	79022026	ST-12226	FIELD QUEEN		A2438	CH-12826	FINI	
73050258	CH12-11389	79042202	CH-12286	72056	CH12-12251	A2442	CH-12235	017023000	CH08-11003
73051818	CH12-12251	79042203	ST09-12265	73430	CH16-12253	A2448	CH-12232	017025000	CH-11210
73067507	CH08-11288	79043778	CH12-11389	73431	SC-12252	A2464	ST06-11315	017026000	CH-12532
73067508	ST08-11316	79043779	SC12-11391	FILGA		A2465	CH08-11288	017027000	CH-13489
73119795	CH08-11288	79043780	CH14-12245	FF-821	CH-12208	A2466	ST08-11316	FINN	
74021443	CH08-12243	79043781	SC14-12254	FFA-900	CH-12248	A2467	CH-12231	FFA-10883	CH-12385
74055125	CH-12262	79049790	ST06-11315	FFA-901	CH-12386	A2477	CH04-11675	FFA-711	CH-12213
74055126	CH-12262	79049791	CH06-11295	FFA-905	CH-12397	A2480	CH-16873	FFA-741	CH-11348
74055745	CH-11348	79062700	ST06-12048	FILT		A2484	CH-12271	FFA-745	CH-12660
74146001	CH-11348	79067204	CH08-11935	A2009	CH-11348	A2485	CH-12285	FFA-746	CH-12826
74357487	CH-12262	79072797	CH08-11935	A2096	CH-12206	A2494	CH-12272	FFA-787	CH-12250
74371576	CH-11348	79081327	CH06-11056	A2096/121	CH-12206	A2498	CH08-12221	FFA-787	CH-16874
74789056	CH05-11106	79081328	ST-12226	A2123	CH-12262	A2513AL	CH09-12244	FFA-788	CH-16873
74841879	CH05-11106	79083212	CH08-11288	A2178	CH-12262	A2516AL	CH-12275	FFA-792A	CH16-12253
74861641	CH08-12243	79083213	ST08-11316	A2201	CH-12249	A2525	CH-12246	FFA-792B	SC-12252
74907794	CH05-11106	79292365	CH-12397	A2217	CH-12207	A2527	CH-12653	FFA-795	CH12-11389
74909733	CH08-12243	79917419	CH12-12251	A2219	CH-12839	FILTER MEX		FFA-799	CH14-12245
74971959	CH-12204	79917881	CH12-12251	A2221	CH-12208	FMA1532K	CH06-14733	FFA-803	CH-12214
74972500	CH-12204	79921320	CH12-11389	A2222	CH-13157	FMA1544S	ST08-11316	FFA-805	CH-12980
74972550	CH-12204	79923130	CH12-11389	A2233	CH-12210	FMA1570	CH21-17070	FFA-827	CH-12235
74980649	CH-12235	79933225	CH08-12228	A2234	CH-13150	FMA1570S	SC21-17075	FFA-833	CH-12385
74996253	CH05-11106	79933226	ST08-12229	A2276	CH-12091	FMA2	PF-15677	FFA-835	CH-12238
75247062	CH-12385	79933276	CH14-12245	A2289	CH05-11106	FMA216	CH-12207	FFA-842	CH-12234
75247063	ST-13531	79935594	CH09-12244	A2289AL	CH05-11106	FMA224	CH-12208	FFA-843	CH-12232
75248729	CH-12242	79955749	ST-12226	A2301	CH-12216	FMA226	CH-12214	FFA-895	CH12-12251
76626089	SC10-11317	79955976	CH06-11056	A2302	CH-12215	FMA229	CH-12209	FFA-897	CH-12660
76626097	SC12-11391	79957810	ST-12226	A2306	CH-12212	FMA244	CH-12260	FFA-898	CH-12283
76676852	SC-12274	79957811	CH06-11056	A2312	CH12-12251	FMA253	CH06-11038	FFA-899	CH-12213
77021413	CH12-12251	79957888	SC10-11317	A2319	CH-12209	FMA254K	CH10-12224	FFA-913	CH-12262
77306750	CH08-11288	79957889	CH12-11389	A2336	CH-12214	FMA256K	CH05-11106	FFA-937	CH-12242

Cross Reference by Manufacturer



MFRS. NO.	OUR NO.	MFRS. NO.	OUR NO.	MFRS. NO.	OUR NO.	MFRS. NO.	OUR NO.	MFRS. NO.	OUR NO.
FFA-944	CH-13156	AF1733K	CH08-11288	AF25250	CH-13889	AF25551	CH05-15887	AF26403	CH-17541
FFA-952	CH-12264	AF1735K	CH09-12244	AF25251	CH-13939	AF25555	CH-17490	AF26419	CH-17542
FFA-953	CH-12246	AF1752M	CH-12289	AF25260	CH-14387	AF25558	ST08-17366	AF26439	CH-17203
FFA-955	CH-11211	AF1773	PF-15683	AF25264	CH-14900	AF25565	CH-16490	AF27843	CH-17594
FIRESTONE		AF1782	CH-12781	AF25290	CH05-14409	AF25566	ST-16494	AF27854	PF-17644
CF-3441	PF-15684	AF1798	CH-12234	AF25291	CH07-14865	AF25574	PF-15701	AF27866	PF-17844
CF-3575	PF-15683	AF1801	CH-12980	AF25292	CH08-17365	AF25575	CH05-15887	AF27869	CH-17762
FISPA		AF1802	CH-12278	AF25302	CH-14722	AF25618	ST09-16731	AF27960	PF-18174
FAC508	CH-11348	AF1804	CH-12238	AF25303	ST-14715	AF25619	CH-16521	AF27963	PF-18559
FAC677	CH05-12222	AF1823K	CH05-11467	AF25305	PF-15441	AF25622	SC-16522	AF335M	CH-12214
FAC681	CH06-11056	AF1824	ST-13410	AF25306	PF-15699	AF25627	CH-16922	AF336M	CH-12210
FAC682	ST08-11316	AF1830KM	CH06-11056	AF25313	CH-14902	AF25672	PF-15669	AF337	CH-12207
FAC683	CH08-11288	AF1835	CH-12867	AF25314	CH-14896	AF25702	ST-15255	AF338	CH-13156
FAC800	ST08-12229	AF1839	ST-12226	AF25315K	CH-14154	AF25703K	CH-15267	AF340	CH-13150
FAC801	CH08-12228	AF1840	ST-13531	AF25319	PF-15700	AF25715RH	ST-15411	AF343	CH-13157
FAC804	CH06-11295	AF1841	ST-13527	AF25321	ST-14183	AF25716RH	ST-15400	AF344M	CH-12208
FAC805	ST06-11315	AF1842	ST-13530	AF25326	SC-15681	AF25721	CH-16491	AF350KM	CH10-12224
FAC934	CH-12216	AF1843	ST-13529	AF25331	CH-14237	AF25722	ST-16495	AF353K	CH12-12251
FAC935	CH-12215	AF1845K	CH06-12258	AF25333	CH-16523	AF25723	CH-16492	AF354	CH-12262
FAC972	CH-12809	AF1859	SC06-11252	AF25335	CH-15673	AF25724	ST-16496	AF361	CH-12260
FAC974	CH-12386	AF1869	PF-14090	AF25337M	CH-15475	AF25726	ST-16877	AF361M	CH-12260
FAC975	CH-12385	AF1869	PFM-14095	AF25343	CH-14334	AF-25727	CH-16489	AF4020	CH-12206
FAC976	CH-12246	AF1904M	SC14-12254	AF25344	CH-14340	AF25728	ST-16493	AF4024	CH-12177
FAC978	CH-12247	AF1905M	CH14-12245	AF25348K	CH08-14835	AF25729	CH-16881	AF4027	CH-12213
FAC980	CH-12235	AF1927	CH-13050	AF25351	CH-12870	AF25730	ST-16875	AF4039	CH-12660
FAC981	CH-12242	AF1929	CH-12276	AF25352	CH08-14410	AF25741	ST-12689	AF4047	CH-12204
FAC982	CH-12231	AF1945	CH-12857	AF25353	CH-13644	AF25753	ST-15557	AF4049	PF-15680
FAC984	CH-12302	AF1960	CH-13510	AF25424	ST-16879	AF25756	CH-14888	AF4057	CH-12248
FAC985	CH-12248	AF1961	CH-13520	AF25434	ST05-14402	AF25767	CH-16969	AF4058	CH-12386
FAC986	ST-13527	AF1962	CH-12604	AF25436	CH06-16050	AF25768	ST-16970	AF4059K	CH08-11288
FAC988	CH14-12245	AF1963	CH-12605	AF25437	CH-16689	AF25769	CH-16971	AF4060	CH-12235
FAC989	CH-12235	AF1966	ST-14343	AF25454	CH-16294	AF25770	ST-16972	AF4064	CH-12653
FAC990	CH05-11106	AF1980	ST08-11110	AF25457	ST-17103	AF25773GK	PF-15015	AF4066	CH-12397
FAC992	CH10-12224	AF25000	CH-13090	AF25468	SC-16301	AF25794	ST08-14708	AF-4067	CH-12230
FAC993	SC14-12254	AF25002M	CH-13075	AF25484	ST07-14270	AF25795	CH08-14703	AF4074	CH-12215
FAC995	CH-12213	AF25006K	CH-13824	AF25485	ST08-14413	AF25797	PF-15672	AF4078	CH-12216
FAC996	CH-11211	AF25029	CH-14380	AF25490	ST-16880	AF25799	PF-14910	AF4084	CH-12250
FAC999	SC12-11391	AF25057	CH12-11343	AF25491	ST10-15380	AF25825	PF-15470	AF4084	CH-16874
LI-2616	CH-11348	AF25057	CH-13477	AF25492	CH-16928	AF25841	PF-15671	AF4085	CH-11348
LI-2695	CH-11348	AF25060KM	CH-13473	AF25497	ST06-16054	AF25849	PF-15891	AF4088	CH-12249
FLEETGUARD		AF25061	CH-13190	AF25499	ST-17092	AF25855	PF-15857	AF409KM	CH08-11003
AF1601M	CH-12232	AF25064	CH-12385	AF25500K	CH-14211	AF25957	CH09-16729	AF4102	CH-12219
AF1604	SC18-17232	AF25065	CH-12242	AF25502K	CH-12290	AF25964	CH10-15371	AF4103	ST08-11316
AF1605M	CH18-17230	AF25066	CH-12387	AF25503	ST-14113	AF25978	ST08-14829	AF4106	CH-12839
AF1606K	CH06-14733	AF25084	ST-16938	AF25523	SC-16290	AF26119	PF-16185	AF4128	PF-15677
AF1606KM	CH06-14733	AF25200K	CH-12739	AF25526	CH07-14074	AF26190YJ	PF-16591	AF4135	CH-12231
AF1614	CH-12752	AF25221	PF-15703	AF25529	ST-14787	AF26230	CH-16284	AF4137	CH-12091
AF1615	CH-12212	AF25230	ST-17470	AF25538	CH04-14412	AF26348	CH-16888	AF4149	CH-12264
AF1658K	CH04-11675	AF25249M	CH-15300	AF25539	CH05-14409	AF26387	CH-16878	AF4150	ST09-12265

Cross Reference by Manufacturer



MFRS. NO.	OUR NO.	MFRS. NO.	OUR NO.	MFRS. NO.	OUR NO.	MFRS. NO.	OUR NO.	MFRS. NO.	OUR NO.
AF4164K	CH08-12228	AF4856M	CH08-11942	AF981	CH-12236	2000E-6228	CH05-11106	A830X9601AMA	CH-16873
AF4165	ST08-12229	AF4867	CH-12507	AF988	ST06-11315	200E6228	CH05-11106	A830X9601ANA	CH-12235
AF418	CH12-11389	AF4872	CH-12847	AF990	CH-12285	217490	CH05-11106	A830X9601ARA	CH-12238
AF418M	CH12-11389	AF4890	CH-13185	AF991	CH-12225	221406	CH05-11467	A830X9601ASA	CH-12660
AF421M	CH-12273	AF4891M	CH-13074	AF996M	CH-11020	221407	CH05-11467	A830X9601AUA	CH-12264
AF424	CH14-12245	AF4892K	CH-13270	AH1107	DL-17329	221409	CH06-14733	A830X9601BAA	CH-12247
AF424M	CH14-12245	AF4893M	CH-12790	AH1136	DL-16550	221688	CH05-11467	A830X9601BBA	CH-12246
AF427M	CH-12269	AF4894KM	CH10-12390	AH1141	DL-16560	222531	CH12-12251	A830X9601BDA	CH14-12245
AF434KM	CH10-11308	AF4894KM	CH10-14455	AH1190	DL-17331	227456	CH12-11389	A830X9601BEA	CH-12278
AF435KM	CH05-11106	AF4901	CH-13404	AH1196	DL-17335	227671	SC12-11391	A830X9601BFA	CH-12283
AF437KM	CH06-11038	AF4905M	CH-12798	AH1198	DL-17333	249571	CH10-11308	A830X9601BGA	CH-11211
AF4500	CH-12485	AF4909K	CH-13811	AH19002	DL-16862	249572	SC10-11317	A830X9601BKA	PF-15680
AF4501	CH-12491	AF490M	SC12-11391	AH19003	DL-16859	254521	CH05-11106	A830X9601BSA	CH-12231
AF4503	CH-12278	AF4915	PF-15690	AH19004	DL-16864	272744	ST-13410	A830X9601BUA	CH08-11288
AF4510	ST06-11109	AF4916	PF-15693	AH19037	DL-16141	276766	CH14-12245	A830X9601CAA	CH-12980
AF4521	ST-16488	AF4917	CH-11789	AH19220	DL-17336	276767	SC14-12254	A830X9601CBA	CH-12232
AF4522	ST-16487	AF492	CH-12209	AH8513	DL-15751	373376	CH08-11288	A830X9601CCA	CH-12385
AF4523	ST-13528	AF4920	CH-13763	FS19605	PF-16800	375272	ST09-12265	A830X9601CEA	CH-12213
AF4525	CH-12953	AF4927	CH-15294	FS19615	PF-15660	375273	CH09-12244	A830X9601CGA	CH-12242
AF4551	CH-12225	AF4939	CH-12716	FS19733	PF-16805	376826	ST08-11316	A830X9601CHA	CH-12248
AF4565	CH-12500	AF4941	CH08-12243	FS19752	PF-16803	377055	CH06-11295	A830X9601CJA	CH12-12251
AF4566	CH-12279	AF4968	CH-14107	FS19803	PF-16738	377059	ST06-11315	A830X9601CKA	CH-16873
AF-4568	CH-12241	AF4972	CH-12825	FLEETRITE		452529	CH-12794	A830X9601CLA	CH-12235
AF4569	CH-12498	AF4980KM	CH-12345	AFR8435KM	CH05-11106	516716	CH08-12243	A830X9601LA	CH05-11106
AF4570K	CH06-11941	AF4981M	CH-12794	FLUXFILTER		616520	CH05-11106	A830X9601SA	CH-12231
AF4589	SC10-12395	AF4991	CH-12775	AC224	CH-12208	616720	CH05-11106	A830X9601UA	CH08-11288
AF4597	PF-15684	AF804M	SC10-11317	AC226	CH-12214	6F-2647B	ST08-11316	C5NE-9A641-A	CH-12209
AF4608	PF-15686	AF818K	CH08-12221	AC233	CH-12210	79HF-9601-BA	CH06-12258	C6JZ-9600-B	CH08-12243
AF4609	CH-12403	AF819KM	CH05-12222	AC236	CH-13156	81DB-9601-BA	CH12-11389	C7JZ-9600-C	CH08-12243
AF4641M	CH-11211	AF820M	SC14-12254	AC237	CH-13157	82-56-032	CH05-11106	C7NN-9A641-A	CH-12209
AF4643	CH-12286	AF821M	SC-12274	AC266SY	CH-13141	82-57-914	CH05-11106	C7NN-9A641-C	CH-12209
AF4644	CH-12302	AF822M	SC-12270	AC535	CH-12273	86509128	CH-12235	C7TA-9600-G	CH10-11308
AF4654	ST06-12048	AF830	CH-14104	FODEN		86509129	ST-13529	C8TZ-9601-C	CH10-11308
AF4655KM	CH06-11880	AF851M	CH-12266	42391/1	CH12-11389	86512886	CH04-11675	D0HZ-9601-G	CH14-12245
AF4657	CH-15565	AF853	CH-12268	Y00704404	CH-12262	A700X-9601-AHA	CH-11348	D0JJ-9600-B	CH08-12243
AF4658	SC-15604	AF863M	CH-12282	Y02520504	CH12-11389	A760X-9601-CA	CH-11348	D0NN-9B618-B	CH-12209
AF4663	PF-15688	AF880	SC21-17075	Y03547112	CH14-12245	A780X-9601-AFA	CH12-11389	D2JL-9600-B	CH10-11308
AF4691	CH-12809	AF889	SC14-13357	Y05753412	CH12-11389	A780X-9601-CA	CH-12397	D2JL-9600-B 1	SC10-11317
AF4714	CH-12093	AF899M	CH21-17070	Y05753510	CH14-12245	A780XX-9601-AF	CH12-11389	DL9601A	CH10-12224
AF471M	SC-12252	AF901	CH14-13356	Y05754209	CH16-12253	A800X-9601-HA	CH-11348	E59Z-9601-A	PF-15684
AF4720	CH-12283	AF921M	CH-12271	FORD		A830X9601AAA	CH-12980	E59Z9601AA	PF-15684
AF472M	CH16-12253	AF922	CH-12272	129040	CH08-12243	A830X9601ABA	CH-12386	E69E-9601-AA	PF-15684
AF-4744	CH-12181	AF940K	CH06-11295	138169	CH12-12251	A830X9601ACA	CH09-12244	E6NN-9B618-AA	CH-12209
AF4745	ST-16876	AF945K	CH-12275	138641	CH08-12243	A830X9601ADA	CH-12232	E9NN-9B618-BA	CH-14722
AF4748K	CH08-11935	AF959	CH-13141	143644	CH12-12251	A830X9601AEA	CH-12385	E9NN-9R500-AB	ST-14715
AF4758KM	CH-12770	AF969	CH-12826	164090	CH05-11106	A830X9601AGA	CH-12213	F4BZ7A098A	SC12-11391
AF4775	CH-12277	AF970	CH-16873	173837	CH12-12251	A830X9601AJA	CH-12242	SBA314530360	CH04-11675
AF4841	CH-15304	AF977	CH-12247	197362	CH05-11467	A830X9601AKA	CH-12248	SBA314531072	CH05-11106
AF4850	ST05-14980	AF978	CH-12246	198492	CH05-11106	A830X9601ALA	CH12-12251	X-13692	CH12-12251

Cross Reference by Manufacturer



MFRS. NO.	OUR NO.	MFRS. NO.	OUR NO.	MFRS. NO.	OUR NO.	MFRS. NO.	OUR NO.	MFRS. NO.	OUR NO.
FORD FINISCODE		5011560	CH-12235	CA-3224	CH-12213	CA-4666	CH-14107	CA-597	CH-12268
1499359	CH-11348	6061641	CH06-12258	CA-3224A	CH-12213	CA-4684-SY	ST-13529	CA-6317	CH-12234
1823386	CH-12209	6089378	CH12-11389	CA-3227	CH-12660	CA-4685-SY	ST-13527	CA-6526	CH-12249
1863008	CH-14722	FRAM		CA-3227A	CH-12660	CA-4686	CH-12980	CA-663PL	CH-11348
1863008-1	CH-14722	C7178	CH-12242	CA-3249	CH-12091	CA-4771	CH-12781	CA-6666	CH-14107
1866308	CH-14722	CA-1507-SY	SC21-17075	CA-3261	CH10-12224	CA-4772SY	CH-12867	CA-667PL	CH-12839
1869555	ST-14715	CA-1527	CH-12209	CA-3262	CH10-11308	CA-4812	CH-14334	CA-681PL	CH-12953
1869555-1	ST-14715	CA-1531SY	ST-13410	CA-3271	CH-12250	CA-4838	CH-12235	CA-6916SY	ST08-12229
2 003 726	CH-14722	CA-1543SY	ST06-11315	CA-3271	CH-16874	CA-4893	CH-12387	CA-6918	CH-11020
2 003 739	ST-14715	CA-1544SY	ST08-11316	CA-3276	CH-12242	CA-4919	CH-12857	CA-6922	CH-12213
5002462	CH-11348	CA-1569	CH14-13356	CA-3276SY	ST-13527	CA-4920	CH-13050	CA-7088	CH-12716
5004264	CH-12397	CA-1569SY	SC14-13357	CA-3277	CH-12248	CA-4929	CH-13050	CA-7111	CH-12386
5004772	CH12-11389	CA-1570	CH21-17070	CA-3280	CH-12235	CA-4942	CH-11211	CA-7137SY	SC10-12395
5006576	CH-11348	CA-1570SY	SC21-17075	CA-3280SY	ST-13529	CA-4947	CH-12289	CA-7178	CH-12234
5011304	CH-12231	CA-1581	CH-12268	CA-3281	CH-12385	CA-4948	CH-12283	CA-7178	CH-12242
5011310	CH05-11106	CA-1589	ST-12226	CA-3281SY	ST-13531	CA-4962	CH-12231	CA-7179	CH-12232
5011316	CH08-11288	CA-163PL	PF-14090	CA-3283	CH-12653	CA-5022	CH-12386	CA-7201	CH-12604
5011317	CH-12980	CA-163PL	PFM-14095	CA-3290-A	CH-12235	CA-5026SY	CH05-11467	CA-7201SY	CH-12605
5011318	CH-12386	CA-216	CH-12207	CA-3291-A	CH-12232	CA-5027	CH-12271	CA-7211SY	ST-13527
5011319	CH09-12244	CA-224	CH-12208	CA-3291-SY	ST-13531	CA-507	CH14-12245	CA-7242	CH-12397
5011320	CH-12232	CA-226	CH-12214	CA-3295	CH-12231	CA-507SY	SC14-12254	CA-7244	CH-12231
5011321	CH-12385	CA-226SY	CH-13141	CA-3295-SY	ST-16487	CA-508	CH-12275	CA-7431	CH-12272
5011323	CH-12213	CA-229	CH-12209	CA-3307	CH-12847	CA-5155	CH-12283	CA-7458	CH-12091
5011325	CH-12242	CA-233	CH-12210	CA-3441	PF-15684	CA-5176	CH-12498	CA-7458SY	ST-16879
5011326	CH-12248	CA-234	CH-13150	CA-3559	PF-15683	CA-521	CH-12249	CA-7459	CH-12225
5011327	CH12-12251	CA-236	CH-13156	CA-3660	PF-15684	CA-5222	CH-11789	CA-7467	CH-12276
5011328	CH-16873	CA-237	CH-13157	CA-3794	CH-12268	CA-523	CH12-11389	CA-7470SY	ST06-12048
5011329	CH-12235	CA-244	CH-12260	CA-3907	CH-12953	CA-5232	CH12-11343	CA-7490	CH-12403
5011330	CH-12238	CA-244-1	CH-12260	CA-4200	CH-12232	CA-5232	CH-13477	CA-7670	CH-14722
5011331	CH-12660	CA-252	CH-12262	CA-4202	CH-12386	CA-523SY	SC12-11391	CA-7670SY	ST-14715
5011333	CH-12264	CA-252-1	CH-12262	CA-4202-SY	ST-13530	CA-5321SY	ST-13528	CA-7675	CH-12282
5011334	CH-12247	CA-2521SY	ST-12226	CA-4203	CH-12236	CA-534	CH-12271	CA-7687SY	ST08-12229
5011335	CH-12246	CA-2523SY	ST09-12265	CA-4205	CH-12234	CA-534SY	CH-12272	CA-7690	CH08-11942
5011337	CH14-12245	CA-2524	CH06-11056	CA-4208	CH-12238	CA-535	CH-12273	CA-7691	CH-12285
5011338	CH-12278	CA-2557SY	ST-14343	CA-4209	CH-12247	CA-535SY	SC-12274	CA-7709	CH-14237
5011339	CH-12283	CA-256	CH05-11106	CA-4210	CH-12980	CA-5364	CH-13763	CA-7712	CH-12980
5011340	CH-11211	CA-2573	CH-12286	CA-4212	CH-12246	CA-5368	CH-12825	CA-7712SY	ST-13530
5011343	PF-15680	CA-258SY	ST08-11110	CA-4214	CH-12826	CA-541	CH-12403	CAK-1531	CH05-11467
5011545	CH05-11106	CA-2595	CH18-17230	CA-4215	CH-12278	CA-5435	PF-15690	CAK-1532	CH06-14733
5011547	CH-12231	CA-2595SY	SC18-17232	CA-4216	CH-12225	CA-5453	CH-13185	CAK-1544	CH08-11288
5011549	CH08-11288	CA-2611	CH-12177	CA-4219	CH-12285	CA-5455SY	ST-14787	CAK-1563	CH05-11106
5011550	CH-12980	CA-2612	CH-12215	CA-4221	CH-12264	CA-546SY	SC10-11317	CAK-2521	CH06-11056
5011551	CH-12232	CA-265	CH-12262	CA-4276	CH-12276	CA-5521	CH-12953	CAK-2523	CH09-12244
5011552	CH-12385	CA-2650	CH-12212	CA-4277	CH-12283	CA-559	CH14-12245	CAK-255	CH12-12251
5011554	CH-12213	CA-266SY	CH-13141	CA-4278	CH-11211	CA-5590	PF-15686	CAK-256	CH05-11106
5011556	CH-12242	CA-2700	CH-12249	CA-4300	CH-12397	CA-563	CH-12269	CAK-3272	CH06-11295
5011557	CH-12248	CA-3105SY	ST-16488	CA-4337	CH-12289	CA-563SY	SC-12270	CAK-352	CH04-11675
5011558	CH12-12251	CA-3194	CH-12278	CA-4362	CH-12282	CA-586	CH-14104	CAK-3819	CH10-11308
5011559	CH-16873	CA-3201	CH-12216	CA-4584	CH-12809	CA-5872	CH-16689	CAK-4298	CH06-12258

Cross Reference by Manufacturer



MFRS. NO.	OUR NO.	MFRS. NO.	OUR NO.	MFRS. NO.	OUR NO.	MFRS. NO.	OUR NO.	MFRS. NO.	OUR NO.
CAK-4361	CH08-12228	205242	CH-12262	055017	CH05-11106	AH/1030	CH-12238	25096242	CH-12653
CAK-4414	CH09-12244	205713	CH-12262	056014	CH05-11106	AH/1033	CH-12246	25096250	CH-12242
CAK-4817	CH08-11935	GALION		063733	CH04-11675	AH/1035	CH-12247	25096252	CH-12215
CAK-5050S	CH08-12243	625	SC10-11317	087860	CH06-14733	AH/1036	CH-12250	25096254	CH-12216
CAK-5052S	CH05-11106	D-103258	CH14-12245	092397	CH05-11467	AH/1036	CH-16874	25096276	CH08-12228
CAK-508	CH-12275	D-103259	SC14-12254	092398	ST-13410	AH/1040	CH-12214	25096324	CH-12867
CAK-510	CH08-12221	D-106576	CH10-11308	131852	CH08-11003	AH/1041	CH-12207	25096432	PF-14090
CAK-530	CH04-11675	D-114359	CH08-12243	131853	ST08-11110	AH/1043	CH-13157	25096432	PFM-14095
CAK-546	CH10-11308	D-115548	CH04-11675	600023	CH12-12251	AH/1044	CH-13156	25096464	CH-12247
CAK-5520	CH08-14835	D-119394	CH05-11106	GENERAL ELECTRIC		AH/1045	CH-12208	4306113	PF-15683
CAK-553	CH05-12222	D-60382	CH-12262	0DA551/4	CH-12177	AH/1047	CH-12248	5141521	CH08-12243
CAK-5568	CH10-12390	D-73913	CH-12262	0L551E/4	CH12-11389	AH/1053	ST08-11316	6420403	CH-12262
CAK-5568	CH10-14455	D-73914	CH-12262	0L551H/4	CH-12262	AH/1054	CH06-11295	6421537	CH-12262
CAK-565	CH08-11288	D-74314	CH-12262	0L551M/4	CH12-12251	AH/1056	CH-12278	6421538	CH-12208
CAK-565A	CH08-11288	D-79041	CH12-12251	0L551N/4	CH14-12245	AH/1068	CH-12209	6421539	CH-12210
CAK-6916	CH08-12228	D-84371	CH10-12224	DA551/4	CH-12177	AH/1070	CH-12236	6421540	CH-12214
CAK-7082	CH-13270	D-99737	CH12-11389	L551E/4	CH12-11389	AH/1071	CH-12278	6421541	CH-12207
CAK-7109	CH06-11941	D-99739	SC12-11391	L551H/4	CH-12262	AH/1072	CH-12271	6423136	CH-12260
CAK-7324	CH-12770	H-99737	CH12-11389	L551M/4	CH12-12251	AH/1073	CH-12272	6423137	CH-13156
CAK-7468	CH06-11295	GARDNER		L551N/4	CH14-12245	AH/1081	CH05-11106	6424409	CH-13157
CAK-7687	CH08-12228	L-22045	CH-12206	GETMAN		AH/1086	CH-12262	6424410	CH-13150
CAK-7702	CH06-11880	MA-289	CH-12206	284054	CH08-11288	AH/1091	ST06-11315	6424687	CH12-12251
P-29748	CH12-11389	GARDNER-DENVER		284055	ST08-11316	AH/1093	CH-12276	6424688	CH05-11106
P-29870	CH-12266	1502071	CH-12262	604948	SC14-12254	AH/1096	SC10-11317	6424692	CH-12209
P-31488	CH-12235	150726	CH-12269	604950	CH14-12245	AH/1109	CH-12397	6486931	CH12-11389
P-33058	CH-12289	152071	CH-12262	GIESSE		AH30	CH-11348	6486941	CH-12273
PA-2	PF-15677	156292	SC-12274	AH/1001	SC14-12254	GMC		6487013	SC-12274
PA-2571	PF-14090	156296	SC-12274	AH/1003	CH12-12251	0675911	CH14-12245	6487036	CH14-12245
PA-2571	PFM-14095	156297	CH-12273	AH/1004	CH-12231	1553966	PF-14090	6487136	SC14-12254
PA-2713	PF-15680	172994	CH-12273	AH/1005	CH-12264	1553966	PFM-14095	6487244	CH-12269
FRANKLIN		172995	CH-12266	AH/1006	CH12-11389	15586695	CH-12268	6487246	SC-12270
10501684	CH08-11003	2008175	CH-12262	AH/1007	CH-12225	15586696	CH-12268	6487434	CH05-12222
1501725	CH12-12251	2008200	CH-12260	AH/1008	CH-12091	25041591	PF-15683	6487468	SC12-11391
FRIGIKING		2009590	PF-15677	AH/1009	CH-12235	25041593	PF-15683	6487754	CH10-11308
941078	CH04-11675	2010137	CH12-12251	AH/1010	CH-12385	25041956	CH-12385	6487756	SC10-11317
FUCHS		2010260	CH12-11389	AH/1011	CH-12213	25041957	CH-12385	6488182	CH-14104
000 73 052	CH-12385	2010262	CH14-12245	AH/1012	CH-12660	25042135	PF-15677	6488338	CH-12275
FURUKAWA		2010504	CH-12260	AH/1014	CH-16873	25042136	PF-15677	6488342	CH04-11675
00501-03065	CH05-11106	2010507	CH-12266	AH/1015	CH14-12245	25095197	CH-12234	6488346	CH08-11288
03401-06012	CH08-11288	2010508	CH12-11389	AH/1017	CH-12242	25095977	CH-12232	700016	CH16-12253
05101-06023	SC10-11317	2010509	CH14-12245	AH/1018	CH08-11288	25095987	CH-12289	704314	CH-12268
05101-06024	CH10-11308	2010697	SC14-12254	AH/1019	CH-12386	25096141	CH-12278	7980474	PF-15680
05201-06004	CH12-11389	2010698	SC-12252	AH/1022	CH-12283	25096178	CH-12225	7980585	PF-15680
05201-06013	SC12-11391	2010699	SC12-11391	AH/1023	CH-11211	25096184	CH-11020	7987956	CH-12209
388021-11210	CH-16689	2109069	CH08-11288	AH/1024	CH-12215	25096188	CH-11211	7987957	CH12-11389
388021-11220	SC-16290	5A-230	CH-12262	AH/1025	CH-12216	25096224	CH-12213	8994210	CH08-12221
627975-C2	CH14-13356	5B-346	CH-12262	AH/1026	SC12-11391	25096230	CH-12204	8994238	CH-12268
FWD		5B-469	CH-12266	AH/1027	CH-12285	25096234	CH-12248	8994494	CH06-14733
203183	CH-12262	GEHL		AH/1029	CH-12234	25096238	CH-12235	8994516	CH14-13356

Cross Reference by Manufacturer



MFRS. NO.	OUR NO.	MFRS. NO.	OUR NO.	MFRS. NO.	OUR NO.	MFRS. NO.	OUR NO.	MFRS. NO.	OUR NO.
8994518	SC14-13357	91107151	CH-12857	GA-18	CH-12209	FC538	CH-13763	310A	ST06-11109
8994522	CH08-11288	9218797	CH-12260	GA-18M	CH-12209	FC818	CH-16689	313AF	CH06-12258
8994524	ST08-11316	93152006	CH-12247	GA-206	SC14-12254	FC832	CH-16928	321A	CH-12781
8994542	CH-12847	93152016	CH-12225	GA-206M	SC14-12254	FC833	ST10-15380	327A	ST08-11316
8994564	CH05-11467	93152017	CH-12285	GA-2286	CH-13141	FC843	CH-16294	328A	CH-12231
8994587	ST-12226	93152039	CH-12247	GA-24M	CH12-12251	FC844	SC-16301	329A	CH10-11308
8994589	CH06-11056	93152088	ST08-11316	GA-262	SC-12274	GRAY MARINE		329AF	CH10-11308
8994619	CH-12282	93152216	CH-12091	GA-271	PF-15683	F-227F-50	CH05-11106	339A	CH-12857
8994635	ST06-11315	93152231	CH-12246	GA-271M	PF-15683	F-277F-502	CH05-11106	344A	CH-12867
8994637	CH06-11295	93152232	CH-12236	GA-277	PF-15684	L-176	CH05-11106	347A	CH-12247
8994643	CH08-11288	93152236	CH-12826	GA-2798M	CH-12242	L-177	CH05-11106	349A	ST-13531
8994649	CH-13141	93152303	CH-12264	GA-326	CH14-12245	LO-177	CH05-11106	350A	ST-13527
8994710	CH10-12224	93152421	CH-11211	GA-326M	CH14-12245	TD-427F-43	CH08-12243	351A	CH04-11675
8994720	CH-12260	9391461	CH14-12245	GA-33	CH05-11106	GREGOIRE		351AF	CH04-11675
8994728	CH08-11003	9974137	CH-12212	GA-33M	CH05-11106	170044	CH08-11935	GROUP 7	
8994729	CH08-12243	9974646	CH10-11308	GA-356	CH-12266	170046	CH-12225	VA-1697	PF-15684
8994732	CH12-11389	9974648	SC10-11317	GA-360	CH12-11389	GREYFRIARS		VA-3192	PF-15683
8994736	CH-12273	9974649	CH09-12244	GA-360M	CH12-11389	127A	CH-12177	VA-3465	PF-15684
8994737	CH-12273	9974668	CH-12208	GA-361	SC12-11391	1345A	ST-14787	GROVE	
8994740	CH14-12245	9974703	CH-12213	GA-405	CH-12235	170A	CH-11348	7-304-00011	CH10-11308
8994742	CH-12269	GMC-HOUSINGS		GA-416	CH06-11056	205A	CH-12826	7-304-100001	CH14-12245
8994743	CH-12269	0702016	CH-12268	GA-461	CH-12605	216A	PF-15680	7-437-100135	CH12-11389
8994744	CH10-11308	GOLDEN FILTER		GA-569	CH21-17070	217A	CH-12213	8385294	CH-12225
8994745	CH10-11308	AF109	CH-12403	GA-569M	CH21-17070	235A	CH05-11106	8752811	CH12-11389
8994746	CH05-11106	AF859	ST06-11109	GA-570M	SC21-17075	235AF	CH05-11106	8755193	PF-15680
8994747	CH05-11106	GOLDEN SUPER		GA-8047	CH-12208	238AF	CH12-12251	8985294	CH-12225
8994750	CH06-11038	1031PL	CH08-12243	GA-890M	CH-12262	239A	CH12-11389	8988242	CH08-11288
8994764	SC12-11391	842PL	CH-12208	GA-892	ST06-11315	240A	CH-12262	9-304-100001	CH14-12245
8994765	SC12-11391	GOLDONI		GA-89M	CH-12262	246A	CH-12653	9-304-100003	CH16-12253
8994766	SC10-11317	27516	CH-12135	GA-9045	CH-12210	247A	CH08-11288	9-304-100023	CH16-12253
8994767	SC10-11317	6340310	CH05-11106	GA-9045M	CH-12210	247AF	CH08-11288	9-304-100068	SC12-11391
8994768	CH05-12222	6340317	ST05-11108	GA-9334	CH-12214	249A	CH-12250	9-304-100074	SC14-12254
8994770	SC14-12254	6340328	CH08-11003	GA-9334M	CH-12214	249A	CH-16874	9-304-100077	CH06-14733
8994772	SC-12274	6340366	CH08-11998	GA-98M	CH08-12221	251A	CH14-12245	9-304-100084	ST08-11316
8994774	SC-12270	6340421	ST-12106	GAK-1532	CH06-14733	259A	CH-12235	9-304-100091	CH05-11467
8994937	CH-12177	GONHER		GAK-216	CH06-11056	260A	CH-12209	9-304-100099	SC10-11317
8994961	CH-12209	G-1285M	CH-13157	GAK-24	CH12-12251	261A	CH-12248	9-304-100113	CH04-11675
8994979	SC10-12395	GA-1008	CH-12207	GAK-625	CH09-12244	272A	CH-12386	9-304-100123	CH16-12253
8994985	ST06-11315	GA-1008M	CH-12207	GAK-98	CH08-12221	281A	CH-12246	9-304-10091	CH05-11467
8995167	CH-12268	GA-106	CH14-12245	GAK-98M	CH08-12221	282A	CH-12236	9-304-990010	CH-12235
9030537	CH-12262	GA-106M	CH14-12245	GAK-99	CH-12275	287A	CH-12242	9-304-990030	CH14-12245
9030894	CH12-12251	GA-118	CH05-12222	GAP-379	PF-15677	288A	CH-12385	9-304-990031	SC14-12254
9038407	CH-12269	GA-118M	CH-12231	GAP-379M	PF-15677	291A	CH-12660	9-304-990050	ST-13527
9038898	CH12-12251	GA-1285	CH-13157	GAP-381	PF-14090	297A	CH-12264	9-304-990051	CH-12242
9038899	CH-12273	GA-1285M	CH-13157	GAP-381	PFM-14095	298A	CH-12213	9-304-99030	CH14-12245
9038902	CH-12260	GA-1286	CH-13156	GPC		299A	CH-11211	9-414-100884	CH04-11675
9049489	SC-12274	GA-1286M	CH-13156	FC106	CH-12385	303A	CH-12249	9-414-100912	CH-12091
91008551	CH14-12245	GA-1287	CH-13156	FC217	CH-12235	303AT	CH-12249	9-437-100135	CH12-11389
91021394	CH16-12253	GA-1287M	CH-13150	FC252	CH-12242	304A	CH-12289	9-437-100136	SC12-11391

Cross Reference by Manufacturer



MFRS. NO.	OUR NO.	MFRS. NO.	OUR NO.	MFRS. NO.	OUR NO.	MFRS. NO.	OUR NO.	MFRS. NO.	OUR NO.
9-437-100309	CH09-12244	G12-7787	ST08-12229	ADG508	CH-12225	AG139	CH-11348	14-5317	SC10-12395
9-437-990005	SC-12252	G12-8407	CH18-17230	ADG516	CH-12385	AG140A	CH-12177	HAGIE	
GUARDIAN		G12-8408	SC18-17232	ADG518	CH08-12221	AG142	CH-12839	29294	CH08-12243
G01-7064	CH-12262	G13-0502	CH-12286	ADG519	CH08-11288	AG305	CH-12212	319700-P01	CH05-11106
G04-2133	PF-15684	G13-0761	CH06-11056	ADG524	CH14-12245	AG373	CH-12249	319700-PO	CH05-11106
G10-0890	CH-12262	G13-0763	CH-12275	ADG525	SC14-12254	AG383	CH-12213	319709-P01	CH05-11106
G10-1222	CH06-11038	G13-0771	CH-14104	ADG533	SC12-11391	AG385	CH-12660	HAKO	
G10-1237	CH12-12251	G13-1333	CH-12273	ADG534	CH08-11288	AG417	CH-12826	0009933006	CH-12397
G10-1275	CH05-11106	G13-1394	ST08-11110	ADG535	ST08-11316	AG445	CH-12660	HALLA	
G10-2090	CH-12260	G13-6390	CH-12209	ADG537	CH10-11308	AG524	CH14-12245	1904550L	CH-12278
G10-2745	CH04-11675	G15-1276	ST-13530	ADG538	SC10-11317	AG579	CH-12250	439203768	CH12-11389
G10-3951	PF-15677	G17-1340	CH-12091	ADG543	CH05-11106	AG579	CH-16874	79103228	CH12-11389
G10-6587	CH12-11389	G17-2250	CH-12980	ADG546	CH-12208	GUIOT			
G10-6632	CH16-12253	G17-2253	CH-12386	ADG563	CH12-12251	GA.1017	CH-12215	00353264	CH-12091
G10-6769	CH14-12245	G17-2500	CH-12225	ADG577	CH-12231	GA.1018	CH-12216	2241329	ST-13531
G10-6775	SC14-12254	G23-4401	CH-12242	ADG586	CH06-11295	GA.1050	CH-12248	259284	CH-12232
G10-6834	SC12-11391	G23-4402	CH-12248	ADG587	ST06-11315	GA.1060	CH-12249	278947	CH-12980
G10-8668	CH10-11308	G23-5000	CH-12234	ADG603A	CH-12386	GA.1065	CH-12660	HANOMAG	
G10-8674	SC10-11317	G23-5001	CH-12242	ADG617	CH-12275	GA.1066	CH-12386	3095082M1	PF-15679
G10-8736	CH05-12222	G24-6501	CH-12235	ADG619	CH09-12244	GA.1067	CH-12385	HANOMAG-HENSCHEL	
G10-9085	SC-12274	G24-7001	CH-12238	ADG620	ST09-12265	GA.1068	CH-12248	156-946-109	CH-12232
G10-9086	CH-12273	G-2S1285	CH-13157	ADG625	CH06-11056	GA.1070	CH-12235	197-946-146	CH12-12251
G10-9155	CH-12266	G-2S1286	CH-13156	ADG626	ST-12226	GA.1087	CH-16873	197-946-184	SC12-11391
G10-9200	CH-12269	G-2S1287	CH-13150	ADG631	ST-13530	GA.1090	CH-12232	197-946-185	CH12-11389
G10-9206	SC-12270	G43-0510	CH-12209	ADG644	CH-13157	GA.229	CH-12209	197-946-201	CH-16873
G11-3343	SC10-12395	G43-1600	CH-11020	ADG649	CH-12214	GA.252	CH-12262	3096340M91	CH-12286
G11-4500	ST06-11315	G47-5975	CH-12289	ADG650	CH-13156	GA.255	CH12-12251	4916566M1	ST07-14270
G11-4747	CH08-12221	G-4M8047	CH-12208	ADG651	CH-12210	GA.256	CH05-11106	4916567M1	CH07-14074
G11-7092	CH-12282	G-4M9334	CH-12214	ADG652	CH-13150	GA.2650	CH-12212	HARMO	
G11-7781	SC21-17075	G-4M9378	CH-12207	ADG654	CH-13157	GA.3224	CH-12213	A2033	CH-12250
G11-7782	CH21-17070	G-4N0015	PF-14090	ADG674	CH-12242	GA.3271	CH-12250	A2033	CH-16874
G11-8211	CH14-13356	G-4N0015	PFM-14095	ADG694	CH14-12245	GA.3271	CH-16874	A2067	CH-11348
G11-8216	SC14-13357	G-4N313X	CH-12272	ADG695	CH08-12221	GA.507	CH14-12245	A2084	PF-15684
G11-9135	CH06-11295	G-4N326X	CH-12271	ADG699	ST-14343	GA.523	CH12-11389	A2085	CH-12385
G11-9136	CH08-11288	G-7M9045	CH-12210	ADG708	ST08-12229	GA.663	CH-11348	A616	CH-12206
G11-9363	CH08-11288	G80-3915	CH14-12245	ADG709	CH08-12228	GA.666	CH-12206	A618	CH-12839
G11-9410	ST08-11316	G83-2121	CH-12216	ADG731	CH-12246	GULDNER			
G11-9538	CH06-14733	G83-2122	CH-12215	ADG752	CH-12857	0009839010	CH-12953	A626	CH-12177
G11-9649	ST-12226	G-9S9972	CH-13141	ADG756	CH-12247	0009839012	CH-12397	A634	CH-11348
G11-9778	ST09-12265	GUASCOR		ADG761	CH-12231	0009839014	CH-12231	A703	PF-15680
G12-0022	CH09-12244	76.50.092	PF-15677	ADG766	ST-16487	0009839015	CH-12386	A720	CH12-11389
G12-0281	CH05-11467	GUD		ADG768	CH-12264	0009839016	ST-16488	A721	CH-12660
G12-0307	ST-13410	ADG381	CH-12209	ADG779	CH-12491	0009839017	ST-16487	A744	CH08-12243
G12-2492	CH08-12243	ADG458	CH-12091	ADG780	CH-12485	0009839019	CH-12285	A759	CH-12213
G12-2510	CH05-11106	ADG478	SC-12274	ADG792	ST-13531	0009839020	ST-13531	A785	CH-12262
G12-3160	ST-14343	ADG479	CH-12273	ADG794	CH-12278	0009839331	CH05-11106	CUA616	CH-12206
G12-4164	CH08-12228	ADG491	SC-12270	ADG808	CH-12386	9831604	CH-12385	CUA618	CH-12839
G12-4526	SC10-11317	ADG492	CH-12269	ADG829	CH-12236	GURIA			
G12-7532	CH-12276	ADG494	CH12-11389	AG108	CH-12206	14-5315	CH-12798	CUA755	CH10-11308
								CUA788	CH12-12251
								P101	PF-15677

Cross Reference by Manufacturer



MFRS. NO.	OUR NO.	MFRS. NO.	OUR NO.	MFRS. NO.	OUR NO.	MFRS. NO.	OUR NO.	MFRS. NO.	OUR NO.
HART-CARTER		AF-245K	CH10-11308	AF-756	CH-12216	HDA-1333	CH-12273	HDA-8216	SC14-13357
257045	CH08-12243	AF-246	SC10-11317	AF-762	CH14-12245	HDA-1334	SC10-12395	HDA-8336	ST06-12048
HASTINGS		AF-284	SC-12274	AF-788	CH-12262	HDA-1344	ST08-11316	HDA-8407	CH18-17230
AF-103	CH-12260	AF-300	CH-14104	AF-836	PF-15684	HDA-1346	CH06-11056	HDA-8408	SC18-17232
AF-104	CH-12208	AF-319	CH-12847	AF-842	PF-15683	HDA-1350	SC10-11317	HDA-8668	CH10-11308
AF-105	CH-13157	AF-323	CH-12268	AF-87	CH-12262	HDA-1351-1	SC12-11391	HDA-8674	SC10-11317
AF-106	CH-12207	AF-324K	CH05-12222	AF-96	CH-12209	HDA-1352	SC14-12254	HDA-8736	CH05-12222
AF-108	CH-12214	AF-327	CH-12269	AF-97K	CH12-12251	HDA-1394	ST08-11110	HDA-8748	CH05-11106
AF-116	CH-13156	AF-328	SC-12270	FAF-104	CH-12208	HDA-1399	SC-12252	HDA-8846	CH-12215
AF-117	CH-13150	AF-336	PF-15677	FAF-108	CH-12214	HDA-2090	CH-12260	HDA-8852	CH-12216
AF-118	CH-12210	AF-362	CH-12209	FAF-133K	CH05-11106	HDA-2115-1	CH-12275	HDA-8999	CH04-11675
AF-133K	CH05-11106	AF-363K	CH06-11056	FAF-245K	CH10-11308	HDA-2745	CH04-11675	HDA-9085	SC-12274
AF-153K	CH08-12221	AF-365	ST-12226	FAF-323	CH-12268	HDA-3149	CH16-12253	HDA-9135	CH06-11295
AF-154K	CH-12275	AF-370	CH14-13356	FAF-97K	CH12-12251	HDA-3152	SC-12252	HDA-9200	CH-12269
AF-167K	CH04-11675	AF-371	SC14-13357	GF-219	SC14-12254	HDA-3160	ST-14343	HDA-9206	SC-12270
AF-20	PF-14090	AF-417P	CH-12282	KF11	CH-13157	HDA-3179	CH-12273	HDA-9334	CH-12214
AF-20	PFM-14095	AF-458	ST06-11315	KF12	CH-13156	HDA-3313	CH-12260	HDA-9340	CH05-11106
AF-2007	CH-12403	AF-463	CH10-11308	KF13	CH-13141	HDA-4500	ST06-11315	HDA-9363	CH08-11288
AF-2011	CH-12286	AF-465	SC-12274	KF9	CH-13150	HDA-4526	SC10-11317	HDA-9378	CH-12207
AF-2016	CH-12231	AF-477	CH08-11288	HAULAMATIC		HDA-4714	PF-15677	HDA-9410	ST08-11316
AF-2029	CH-12232	AF-478	ST08-11316	900020	CH12-11389	HDA-4747	CH08-12221	HDA-9538	CH06-14733
AF2049	CH-12206	AF-480	CH06-11295	HAWKER SIDDELEY CA		HDA-5444	CH05-11106	HDA-9576	CH-12273
AF2058	CH-12397	AF-481	CH08-11288	02705568	CH10-12224	HDA-5695	SC-12274	HDA-9778	ST09-12265
AF2060	CH-12213	AF-490	CH-12271	02705583	CH12-11389	HDA-5700	CH14-12245	HDA-9972	CH-13141
AF2068	CH-12242	AF-491	CH-12272	69100108	CH14-12245	HDA-5961	PF-15677	HDA-9972-1	CH-13141
AF2079	CH-12289	AF-496	CH-13141	HEAVY DUTY AIR		HDA-6256	CH10-11308	HEDEN	
AF2082	CH-11020	AF-498	CH06-14733	HDA-0022	CH09-12244	HDA-6257	CH08-11003	29800164	CH-13824
AF2092	CH-12235	AF511	CH-12236	HDA-0281	CH05-11467	HDA-6259	CH06-11056	59501503	CH10-11308
AF2095	CH-12285	AF-514	CH09-12244	HDA-0307	ST-13410	HDA-6390	CH-12209	69800011	CH07-14865
AF2153	CH-13157	AF-515	ST09-12265	HDA-0313	CH-12272	HDA-6399	CH-12212	Z76-02-AF932	CH04-11675
AF2154	CH-13156	AF-576	CH21-17070	HDA-0326	CH-12271	HDA-6587	CH12-11389	HENGST	
AF2158	CH-12234	AF-577	SC21-17075	HDA-0502	CH-12286	HDA-6658	CH21-17070	285L	CH-12809
AF-216	SC12-11391	AF-588	CH05-11467	HDA-0591	CH09-12244	HDA-6659	SC21-17075	AF235	CH-12809
AF2164	CH-12206	AF-597	CH-12867	HDA-0760	CH06-11056	HDA-6660	SC-12252	E111L	CH-12397
AF2166	CH-12248	AF-631	ST-14343	HDA-0761	CH06-11056	HDA-6769	CH14-12245	E112LS	ST-16488
AF2168	CH06-11941	AF-635	CH-12385	HDA-0763	CH-12275	HDA-6775	SC14-12254	E113L	CH-12231
AF-217	CH12-11389	AF-637	CH-12225	HDA-0771	CH-14104	HDA-6834	SC12-11391	E114L	CH-12386
AF2170	CH-12283	AF638	CH-12091	HDA-0776	ST-12226	HDA-6840	CH05-11106	E114LS	ST-13530
AF-218	CH14-12245	AF-639	CH-12386	HDA-0890	CH-12262	HDA-6984	ST-12226	E115L	CH-12385
AF2183	CH-12282	AF-643	CH-12276	HDA-0949	ST05-14980	HDA-6989	CH-12269	E115LS	ST-13531
AF2184	CH-12247	AF-644	SC10-11317	HDA-1237	CH12-12251	HDA-6990	SC-12270	E116L	CH-12242
AF2187	ST08-12229	AF-648	CH-12177	HDA-1240-1	CH04-11675	HDA-7092	CH-12282	E116L01	CH-12248
AF-219	SC14-12254	AF-658	CH18-17230	HDA-1275	CH05-11106	HDA-7443	CH16-12253	E116LS	ST-13527
AF2234	CH-12485	AF-659	SC18-17232	HDA-1282	CH09-12244	HDA-7532	CH-12276	E117L	CH-12235
AF2235	CH-12491	AF-661	ST-13410	HDA-1285	CH-13157	HDA-7781	SC21-17075	E118L	CH-12278
AF2240	CH-12249	AF-673	PF-14090	HDA-1286	CH-13156	HDA-7784	CH08-12228	E118LS	ST-13528
AF2241	CH-12278	AF-673	PFM-14095	HDA-1287	CH-13150	HDA-7797	CH-12268	E120L	CH-12285
AF2262	CH-14722	AF-744	SC10-12395	HDA-1328	CH10-11308	HDA-7868	CH08-11288	E127L	CH-11211
AF-235K	CH08-11288	AF-755	CH-12215	HDA-1329	CH10-11308	HDA-8047-1	CH-12208	E149L	CH-12980

Cross Reference by Manufacturer



MFRS. NO.	OUR NO.	MFRS. NO.	OUR NO.	MFRS. NO.	OUR NO.	MFRS. NO.	OUR NO.	MFRS. NO.	OUR NO.
E150L	CH-12232	4085787	CH14-12245	111202	CH05-11106	323272-C91	CH12-12251	AR256	CH05-11106
E151L	CH-15788	4085788	SC14-12254	403217	CH05-11106	323273-C91	CH12-12251	AR502	CH16-12253
E199L	PF-15690	4090408	CH12-11389	8T-2405	CH05-11106	324795-R91	CH-12262	AR507	CH14-12245
E209L	PF-15693	4090409	SC12-11391	HYDRA-MAC		366379-C91	CH12-12251	AR507SY	SC14-12254
E218L	CH-12387	4100806	CH12-11389	4100-021	CH04-11675	380347-R91	CH05-11106	AR523	CH12-11389
E237L	CH-14900	4122937	CH14-12245	4108-311	CH05-11106	380347-R92	CH05-11106	AR536	CH-12266
E275L	CH-12246	4137604	CH08-11288	HY-DYNAMIC		388126-R1	CH05-11106	INGERSOLL-RAND	
E276L	CH-12247	4146898	CH14-12245	104516	CH12-12251	388126-R91	CH05-11106	10349866	CH05-11106
E277L	CH-12091	4206272	CH18-17230	HYMAC		389290-R91	CH05-11106	10349868	CH05-11106
E278L	CH-12225	4206273	CH18-17230	270.0047	CH-12262	425002-R91	CH-12262	118/H/1106	CH12-12251
E278LS	ST-16876	4237633	CH14-12245	270.0228	CH05-11106	427753-R91	CH-12262	118/H/1111	CH-12262
E280L	CH-12236	4237663	CH14-12245	270.7095	CH06-12258	594686-R91	CH05-11106	118/H/1144	CH14-12245
E282L	CH-12238	4244607	SC12-11391	270.9026	CH12-11389	619675-C91	CH-12260	118/H/1154	CH12-11389
E283L	CH-12264	4294845	CH-12739	HYSTER		750205-C91	CH12-12251	35103217	CH-12847
E285L	CH-12809	4294846	CH-12770	123730	CH05-11106	752616-C91	CH12-12251	35109156	CH14-12245
E286L	CH-12234	4326841	ST06-16054	125846	CH05-11106	758008-C91	CH-12262	35109206	SC14-12254
E288L	CH-12250	4337639	SC14-12254	1352670	CH04-11675	761490-C91	CH12-12251	35109263	CH16-12253
E288L	CH-16874	500.414	ST-13527	1369809	CH05-11106	766442-C91	CH14-12245	35109271	SC-12252
E289L	CH-12660	501488	SC12-11391	150836	CH12-12251	768394-C91	CH-12262	35274745	SC-12270
E291L	CH-12283	502826	CH14-12245	154818	CH08-12243	768395-C91	CH-12262	35274752	CH-12269
E76L	CH-11348	502827	SC14-12254	155748	CH12-12251	769432-C91	CH14-12245	35275965	SC-12274
HERCULES		502850	CH-12242	156947	CH-12262	769436-C91	CH14-12245	35275973	CH-12273
400000614	CH08-12243	D106587	CH12-11389	170681	CH08-12243	769436-C92	CH14-12245	35291509	CH05-11467
HESSTON		D911519	CH12-11389	179930	CH12-12251	769722-C91	CH12-12251	35291970	CH06-14733
708722126	CH12-11389	D911762	CH12-12251	179948	CH05-11106	771456-C91	CH12-12251	35298108	CH18-17230
708722134	SC12-11391	D914453	SC12-11391	179955	CH08-12243	771456-C92	CH12-12251	35298116	SC18-17232
HINO		LH42924001	CH06-11038	223137	CH08-12243	771456-C93	CH12-12251	35318252	CH08-11288
10722-21400	CH10-12224	X4326841	ST06-16054	246110	CH10-12224	773305-C91	CH12-12251	35326230	CH09-12244
17801-1090	SC14-12254	HOBART		252792	SC14-12254	774564-C91	CH12-12251	35902295	CH08-12243
17801-1090A	SC14-12254	403997	CH08-12243	326483	CH05-11106	797358-C91	CH-12282	36876423	CH06-14733
17801-1110	CH14-12245	HOKUETSU KOGYO		390221	CH08-12243	873737-C91	CH12-11389	39125547	CH-12847
17801-1110A	CH14-12245	3214300200	CH04-11675	395841	CH08-11288	887977-C91	CH12-12251	39708466	CH-12843
17801-1180	SC12-11391	3214300300	SC-12274	395842	ST08-11316	924279C1	CH10-11308	50265321	CH12-12251
17801-1180A	SC12-11391	3214300600	CH12-12251	SKS-41373	CH05-11106	989573-R91	CH-12262	50344878	CH-12260
17801-1190	CH12-11389	3214300900	CH12-12251	SKS-41373-2	CH05-11106	INDUCONTR0		50554518	CH-12260
17801-1190A	CH12-11389	3214302200	SC-12274	T-966133	CH12-12251	AR1570	CH21-17070	50616390	CH-12266
17801-2020	CH-12273	3214302600	SC-12274	TC-1020610-2	CH12-12251	AR1570SY	SC21-17075	50616416	SC-12274
17801-2030A	SC10-11317	3214302700	CH12-11389	HYUNDAI		AR2	PF-15677	50616424	CH-12273
17801-2040A	CH10-11308	3214303600	CH14-12245	28130-44000	CH04-11675	AR216	CH-12207	51278133	CH12-11389
17801-2260	CH-12273	HOUGH		E211-2103	CH10-11308	AR224	CH-12208	52146958	CH18-17230
17801-2270	CH-12273	115209-H2	CH-12262	IHC HOUSINGS		AR226	CH-12214	52146966	SC18-17232
17801-2290	CH-12273	152776	CH-12262	152776-H1	CH-12262	AR226SY	CH-13141	52252061	CH18-17230
HITACHI		164090	CH-12262	164090-H1	CH-12262	AR229	CH-12209	52269875	CH-12273
151849134	CH08-11942	194229	CH-12262	257881-C91	CH-12262	AR233	CH-12210	52277381	CH21-17070
3214300200	CH04-11675	194273	CH-12262	257881-C92	CH-12262	AR234	CH-13150	5227739	SC21-17075
3214305900	CH04-11675	84198-92	CH12-12251	259921-C91	CH12-12251	AR236	CH-13156	56778442	CH-12269
4059818	SC12-11391	X-75497	CH-12266	259921-C92	CH12-12251	AR237	CH-13157	56778459	SC-12270
4080065	SC10-11317	HUBER-WARCO		306909-C91	CH12-12251	AR253	CH06-11038	58923442	ST08-11316
4080066	CH10-11308	104905	CH12-11389	309967-C91	CH-12262	AR254	CH10-12224	59046797	CH08-14410

Cross Reference by Manufacturer



MFRS. NO.	OUR NO.	MFRS. NO.	OUR NO.	MFRS. NO.	OUR NO.	MFRS. NO.	OUR NO.	MFRS. NO.	OUR NO.
59046805	ST08-14413	AF-20325	CH-12232	9-14215-046-1	CH14-12245	1902129	CH-12278	4059252	CH08-11003
59106393	CH08-17365	AF-24650	CH-16873	9-14215132-0	CH10-12224	1902130	ST-13530	42480759	ST-13527
59144170	CH06-16050	AF-24650/1	CH-12235	9-14215132-1	CH10-12224	1902131	ST-13531	42481020	ST-13529
59144188	ST06-16054	AF-6154	CH-12278	9-14215-140-2	CH12-12251	1902132	ST-13529	42481021	ST-13529
59341560	CH-13824	AF-6182	ST-13527	9-14215-153-1	CH10-11308	1902465	CH-12242	42484344	CH08-11288
59407973	CH04-11675	AFI-6003	CH-12212	9-14215-166-1	CH08-11288	1904550	CH-12278	42484726	CH12-11389
59438804	CH08-11288	AFI-6004	CH-12249	9-14215-170-0	SC10-11317	1904581	CH-12231	42488361	CH-12278
59567255	CH06-14733	AFI-6041	CH-12216	9-14215175-0	CH10-12224	1905620	ST-13528	61654541	CH12-11389
59825562	CH10-11308	AFI-6042	CH-12215	9-14215183-0	CH08-11003	1905710	CH-13763	667078	CH-12387
59888891	CH08-11288	AFI-6121	ST-16488	9-14215184-0	CH10-11308	1905983	CH-12825	79067204	CH08-11935
825562	CH10-11308	AFI-6123	ST-16487	9-14215-193-2	CH12-12251	1907553	CH-14107	79083213	ST08-11316
85400646	CH05-14409	AFI-6159	ST-13531	IVECO		1908233	CH-14387	8014390	CH08-11288
85400679	CH07-14074	AFI-6180	ST-13530	01186044	CH08-11288	1908868	CH-14387	8014410	CH10-11308
85400729	CH08-14410	AFI-6215	ST08-11110	01186046	CH-12385	1909116	CH08-12228	8014430	CH08-11003
91634337	SC-12252	AFI-6220	ST-13529	01186389	CH-12242	1909128	CH06-11056	8015448	ST08-11110
91634345	CH16-12253	AFI-6225	CH-11211	02165039	CH-12231	1909132	ST-13529	8015449	ST08-11316
91672675	CH14-12245	AFI-6225	CH-12283	02165044	CH-12386	1909138	ST-14343	8015450	SC10-11317
91672683	SC14-12254	AFI-6226	CH-12264	02165049	CH-12385	1909139	CH06-11038	8016660	CH12-11388
92003490	CH-12262	AFI-6235	CH-12980	02165054	CH-12242	1909699	CH-12217	8016666	ST12-11390
92035948	CH-12278	AFI-6251-K	CH08-11288	02165059	CH-12235	19303669	CH08-14410	8016966	SC14-12254
92035955	ST-13528	AFI-6252	ST08-11316	02168629	CH-12248	1930476	SC12-11391	8016967	CH14-12245
92055530	CH-12278	ISEKI		02241329	ST-13531	1930587	CH07-14074	8016976	CH14-13356
92058885	CH-12839	1427-101-0140-0	CH-13297	02243946	ST-13527	1930589	CH08-14410	8016977	SC14-13357
92079425	CH10-11308	142710128400	CH04-11675	02414950	ST-13530	1930592	ST05-14402	8019342	CH12-13632
92117431	CH08-11288	1444-101-3700-0	CH-13296	059905104	ST06-11315	1930603	CH10-12390	8019343	SC12-13636
92124213	CH-12285	1480-104-2070-0	CH05-12202	0638274	CH08-11003	1930603	CH10-14455	8020729	CH-13880
92147353	CH06-14733	154410420200	CH-12694	0659387	CH16-12253	1930730	ST06-12048	8023027	CH-14111
92147453	CH06-14733	155010420200	CH-13294	0667690	CH-12273	1930747	CH14-12245	8025818	CH16-12253
92266485	CH12-12251	1560-103-202-40	CH-12716	07980507	SC10-11317	1930764	CH06-11880	8031211	CH07-14074
92266519	CH12-11389	1560-103-202-50	CH-15512	09917419	CH12-12251	1930783	CH-12794	8031565	ST07-14270
92273705	CH14-12245	1572-103-250-00	CH-14047	09921320	CH12-11389	1930784	CH-12798	8032064	CH08-14410
92686922	CH-12242	1729-705-015-1	PF-16892	09923130	CH12-11389	1930786	CH-12790	8032066	ST08-14413
92686930	ST-13527	ISUZU		09927604	CH08-11288	1930792	CH06-11880	8034304	ST12-15870
92686948	CH-12235	1-14215007-0	CH12-11389	09932594	CH09-12244	197588	SC-12252	8092438	ST-13530
92686955	ST-13529	1-14215-007-1	CH12-11389	09933276	CH14-12245	20008157	CH08-11288	8092439	CH-12385
92740984	CH-12278	1-14215-007-2	CH12-11389	09981555	ST09-12265	242495001	CH06-11056	8092441	CH-12242
92740992	ST-13528	1-14215-014-0	CH05-11106	09983764	CH-12235	266786	CH10-11308	8092442	ST-13527
92793025	CH08-14410	1-14215-033-0	SC14-12254	1901779	CH-12235	300136922	CH12-11389	8092444	ST-13528
92867357	CH-13205	1-14215034-0	SC14-12254	1901780	CH-12277	303048581	CH08-11003	8092445	CH-12235
92888718	CH-13115	1-14215046-0	CH14-12245	1901901	CH-12284	3044162	CH10-12224	8092446	ST-13529
92889534	CH-13116	1-14215-046-1	CH14-12245	1901902	CH14-12245	3045583	CH10-12224	8106840	ST-13531
93 793 025	CH08-14410	1-14215-047-0	SC12-11391	1901903	CH12-11389	3046858	CH08-11003	8109774	CH-12386
93191542	CH-13835	14215-006	CH10-12224	1901925	CH-12235	320498850	ST08-11316	8122408	CH-12387
INSLEY		1-87810067-0	CH10-11308	1902040	CH-14104	321549250	SC14-12254	8561046	CH08-11288
915613	CH12-12251	5-14215002-0	CH04-11675	1902048	CH-12242	4025933	CH10-12224	920015933	CH08-11935
IOWA		5-14215-002-1	CH04-11675	1902077	CH-12385	4055125	CH-12262	J.C.BAMFORD	
45690-001-15	CH08-12243	8-97042317-0	CH04-11675	1902121	CH-12231	4055126	CH-12262	2600601	CH05-11106
45690-001-152	CH08-11003	9-14215-017-0	SC10-11317	1902127	CH-12386	4055695	CH-12260	32/201601	SC12-11391
IRLEMP		9-14215034-0	SC14-12254	1902128	CH-12248	4056630	CH10-12224	32/201602	CH12-11389

Cross Reference by Manufacturer



MFRS. NO.	OUR NO.	MFRS. NO.	OUR NO.	MFRS. NO.	OUR NO.	MFRS. NO.	OUR NO.	MFRS. NO.	OUR NO.
32/202501	SC12-11391	AR-39799	CH-12275	RE35522	ST06-12048	KALMAR		1186046	CH-12385
32/202601	ST08-11316	AR-45943	CH12-11389	RE-35523	CH-13074	13.21840	ST-13531	2165029	CH-12397
32/202602	CH08-11288	AR-46003	CH12-11389	RE42725	CH-12345	1920723.0003	ST-13531	2165038	CH-12231
32/203702	CH06-12258	AR-46004	SC12-11391	RE-42725	CH-12345	9231100577	CH-16689	2165039	CH-12231
32/206002	CH06-11941	AR-46973	CH-14104	RE-45827	CH08-12228	9231100578	SC-16290	2165041	CH-12242
32/903001	CH-13185	AR-51923	CH-12257	RE-45828	ST08-12229	KASSBOHRER		2165044	CH-12386
32/903601	CH-13270	AR-64104	CH06-11056	RT6005011111	CH08-14410	8319000050	SC-12274	2165044EZ	CH-12386
32/905002	ST-14787	AR-71635	CH06-11056	RT6005011112	ST08-14413	8319009084	CH-12385	2165049	CH-12385
32/912901	CH-16928	AR-84228	CH06-11056	T-115437	ST-14343	8319039104	CH12-12251	2165054	CH-12242
32/912902	ST10-15380	AT-1131-N	CH05-11106	T-46316	CH10-11308	8319039109	CH12-12251	2165056	CH-12235
32-208304	SC10-11317	AT-131683	SC14-12254	T-46317	SC10-12395	831-905-86-094	CH-12235	2165059	CH-12235
32-913602	ST06-12048	AT175223	CH-16689	U-44956	SC14-12254	831-908-51-02	CH-12242	2165074	CH-12242
988/00031	CH-12653	AT-25981	CH08-12243	U-44957	CH14-12245	831-908-60-94	CH-16873	2168629	CH-12248
AC210	CH-12839	AT-31825	CH05-11106	JOHN DEERE HOUSING		8319095116	CH-12278	2211565	CH-12091
B03210033	CH05-11106	AT-33363	CH-12275	AR-45669	CH-14104	8319098117	CH-16873	2216260	CH-16873
KAP0482	CH-12770	AT-44377	CH08-11003	JOY		KATO		2240348	CH-16873
JAEGER		AT-44378	ST08-11110	00501072	CH08-12243	119-61202000	CH10-11308	2241034	CH-12232
739051	CH08-12243	AT-45018	CH10-11308	005010720030	CH08-12243	KAWASAKY		2241036	CH-12980
JENBACHER WERKE		AT-49022	CH14-13356	00527693	SC-12270	30981-70110	CH08-11288	2241038	CH-12980
162860	CH09-12244	AT-69307	SC-12274	01660264	CH-12847	YYP101237	CH12-12251	2241329	ST-13531
JOHN BEAN		AZ-18968	CH-12231	360628320	SC-12252	YYP106587	CH12-11389	2243521	ST-16879
1410546	CH12-12251	AZ-20623	CH-12386	514795	CH-12262	YYP106769	CH14-12245	2243946	ST-13527
1410549	CH12-12251	AZ-20625	CH09-12244	516566	CH08-12243	YYP106775	SC14-12254	2311565	CH-12091
1410903	CH05-11106	AZ-20626	CH-12386	518566	CH08-12243	YYP106834	SC12-11391	2322855	CH-12225
1410910	CH05-11106	AZ-21745	CH10-11308	5190-0235	CH08-12243	YYP108668	CH10-11308	2323855	CH-12225
JOHN DEERE		AZ-23644	CH-12232	TAX-33N	CH09-12244	YYP108674	SC10-11317	2339812	CH-12091
12X20956-A	CH-12275	AZ-25498	ST-13530	KAELBLE		YYP117431	CH12-12251	2339813	CH-12091
12X20957-A	CH08-12221	AZ-25867	ST09-12265	240.00.389	CH14-12245	YYP117437	CH14-12245	2339823	CH-12225
21X11983-C	CH08-12243	AZ-25868	CH09-12244	240.00.504	CH-12235	YYP119373	SC14-12254	2352341	CH14-12245
21X11984-A	CH08-12243	AZ-26007	ST-13527	240000505	ST-13529	KENWORTH		2352343	SC14-12254
31X10894-A	CH05-11106	AZ-26091	CH-12242	340.00.091	CH10-11308	304334	CH-12260	2379161	ST-16880
41X10894-A	CH05-11106	AZ-30757	CH-12385	340.00.191	ST-13527	30-4401	CH-12260	2379163	ST-16876
AE-31723	CH06-11056	AZ-30758	ST-13531	340.00.291	CH12-12251	9030537	CH-12262	2394637	ST-13529
AE-31724	ST-12226	AZ45870	SC14-12254	340.00.320	CH12-11389	9030854	CH-12260	2408868	CH-12248
AF-19847	CH05-11106	AZ48195	CH-12235	340.00.330	SC14-12254	9191704	CH-12262	2414950	ST-13530
AH-19846	CH05-11106	AZ48196	ST-13529	340.00.460	CH-12242	919704	CH-12262	2415950	ST-13530
AH-19847	CH05-11106	CH-12767	CH05-11106	340.00.489	CH-12385	9206065	CH-12260	2508228	CH-12248
AH-20487-H	CH08-12243	CH-15451	CH04-11675	340.00.490	ST-13531	9206424	CH-12262	2508238	CH-12248
AH-21421	CH08-12221	CH18287	CH08-11288	340.00.594	CH10-12224	9215674	CH-12260	2912005	CH-12386
AL-19918	CH-12275	DDX-18911	CH08-11942	406.00.261	SC14-12254	KERSHAW		2912007	CH-12248
AL-27158	CH-12275	DDX-18913	CH-12798	874.08.0789	SC10-11317	351133	CH-12262	2914182	CH-12248
AL-27159	ST-12226	DOX18913	CH-12798	874.08.0790	CH10-11308	KHD(KLOCKNER-HUMB)		2914182EE01472	CH-12248
AM-102746	CH05-12222	DO08521	CH-12242	KAESER		01522242009	CH-12208	2985037	ST-13530
AN-150200	CH05-11106	DO08522	ST-13527	602 190	CH-12285	0439 7234	CH-12794	3366456	CH-12208
AN-153119	ST-14343	GG420-31932	CH04-11675	619 960	CH-12386	1163766	CH12-11389	41448896	ST-16488
AR-21424	CH08-12221	MG-221406	CH05-11467	619970	CH-12385	1169024	CH06-11295	4144896	ST-16488
AR-39540	CH-12275	MG-272744	ST-13410	619990	ST-13531	1169116	CH08-11288	4144966	ST-13529
AR-39797	CH-12275	PAT-44377	CH08-11003	KALAMAZOO		1169117	ST08-11316	4149014	CH10-11308
AR-39798	CH08-12221	RE-33884	CH08-11942	10000025	CH05-11106	1186044	CH08-11288	4149022	SC10-11317

Cross Reference by Manufacturer



MFRS. NO.	OUR NO.	MFRS. NO.	OUR NO.	MFRS. NO.	OUR NO.	MFRS. NO.	OUR NO.	MFRS. NO.	OUR NO.
4308634	ST-16880	AG155	CH21-17070	SE082	ST08-11316	KOMATSU		600-181-4600	CH14-12245
4308636	ST-16876	AG156	SC21-17075	SE120	ST-13531	3EC-01-25830	CH-12716	600-181-6360	SC10-11317
4319256	ST08-12229	AG179	CH-12209	SE150	ST-13527	418-01-K1170	SC12-11391	600-181-8260	CH10-11308
431-9257	CH08-12228	AG184	ST08-11316	SE210	ST-13529	600-181-6560	SC12-11391	600-181-8300	CH10-11308
4319262	SC10-11317	AG187	CH-12249	SE280	ST-13528	848101105	ST08-11110	600-181-8360	SC10-11317
4319263	CH-12276	AG200	CH-12213	KOBELCO		YMR000463	CH-14393	600-181-9200	CH08-11288
4384102	CH-12091	AG202	CH-12225	2446R277S5	CH09-12244	Z76-02-AF931	CH05-11106	600-181-9240	CH08-11288
4384103	CH-12225	AG206	CH-12212	2446U154S2	SC10-11317	KOMATSU DRESSER		600-182-1100	CH05-11106
KIRKALDIE ENG.		AG207	CH08-11288	2446U154S3	CH10-11308	000VJ5139	CH-12266	6127-81-7310	CH16-12253
KA-100	CH-12214	AG235	CH-12809	2446U185S3	CH14-12245	103258	CH14-12245	6127-81-7320	CH16-12253
KA-108	CH-12260	AG243	CH-11211	2446U212S2	SC-12252	103259	SC14-12254	6127-81-9031	SC-12252
KA-11	CH-12262	AG262	CH-12285	2446U244S1	ST-14343	106579	SC10-11317	848101081	CH06-11295
KA-111	CH-12242	AG273	CH-12289	2446U299S2	ST-14343	115548-H45	CH04-11675	99737	CH12-11389
KA-112	CH-12216	AG274	CH-12264	2451R124-3A	CH08-11288	1201734-H1	SC14-12254	99739	SC12-11391
KA-113	CH-12385	AG300	CH-12870	2451U124-3A	CH12-11389	1266091-H1	CH14-12245	CUAF418M	CH12-11389
KA-114	CH-12386	AG64	CH-12234	2451U124-3B	SC12-11391	203-01K1130	CH08-11935	CUAF490M	SC12-11391
KA-122	CH-12208	AG74	CH-12385	2451U1803A	CH10-11308	20301K1290	ST08-11316	VE1061	SC18-17232
KA-125	CH-12397	AG86	CH-12397	2451U180-3B	SC10-11317	205-01-73570	CH-13473	VE1062	CH18-17230
KA-126	CH-16873	AG87	CH-12231	2451U206-3	SC10-11317	205-01-73750	CH-13473	VJ5175	CH21-17070
KA-136	CH-12213	AG88	CH-12386	2451U221-3	CH05-11106	304880	CH12-11389	YM121120-12901	CH05-11106
KA-14	CH12-12251	AG89	CH-12235	2460U196-4	SC14-12254	304883	SC12-11391	YM171022-1253	CH04-11675
KA-14K	CH12-12251	AG90	CH-12278	3173081800	CH08-11288	305-913-1021	CH05-11106	YM171022-12530	CH04-11675
KA-15	CH05-11106	AG94	CH-12238	KOCKUM-LANDSVERK		34A-02-34130	CH04-11675	Z76-01-18130	CH-12770
KA-15K	CH05-11106	AG96	CH-12242	79443768	CH-12345	34B-02-31930	CH05-11106	Z76-01-25830	CH-12716
KA-18	CH12-11389	AG98	CH-12980	KOEHRING		37Z-02-AF931	CH05-11106	Z760225550	ST-14343
KA-21	CH-12653	EL502N	CH-12953	124326	CH08-12243	37Z-02-AF931L	CH05-11106	Z76-02-34750	CH07-14865
KA-22K	CH08-11288	LKS37	ST-13531	124348	CH12-12251	37Z-02-AF932	CH04-11675	KRALINATOR	
KA-23	CH-12213	LX259	PF-15684	124366	CH08-12243	37Z-02-AF932L	CH04-11675	LA-1001	PF-15683
KA-26	CH-12250	LX335	PF-15693	210-01095	CH10-11308	381-976326-1	CH12-11389	LA-1003	CH05-11467
KA-26	CH-16874	LX345	CH-14107	210-01107	SC10-11317	3EA-01-12130	CH-12770	LA-101F	CH12-12251
KA-29	CH-12660	LX437	CH-12870	4203293	CH-12262	3EA-01-16120	CH04-11675	LA-1048	CH-12283
KA-30	CH14-12245	LX496	CH-11789	4203509	CH-12262	3EA-01-18130	CH-12770	LA-1049	CH-11211
KA-71	CH-12209	LX530	CH-12250	4203523	CH-12262	3EA-01-18130L	CH-12770	LA-1050	CH-12264
KA-83	CH-12262	LX530	CH-16874	4203568	CH08-12243	3EB-01-25380	CH-12716	LA-1102	ST-13530
KA-87	CH-12264	LX531	CH-12387	420356-A	CH-12260	3EB-02-25550	ST-14343	LA-1103	ST-13531
KA-96	CH-12235	LX584	CH-14104	4203572	CH12-12251	400590	SC-12274	LA-1104	ST-13527
KA-97	CH-12248	LX612	CH-14900	7304539	CH05-11106	400594	SC-12270	LA-1106	CH-12289
KNECHT		LX631	CH-15304	8273006	CH08-12243	5501642705	CH-12285	LA-1113F	CH06-11038
AF86	CH-12397	LXS371	ST-13531	8273234	CH05-11467	5527655841	CH04-11675	LA-1142	PF-15684
AG101	CH-12248	LXS401	ST-16488	8273235	ST-13410	581-02-12130	SC21-17075	LA-1159	CH-12278
AG102	CH-16873	LXS411	ST-13530	8273237	CH08-11288	600-181-2461	CH-12605	LA-1166	CH-12278
AG103	CH-12232	LXS421	ST-13527	8273238	ST08-11316	600-181-2500	CH-12604	LA-1258F	CH08-12228
AG108	PF-15684	LXS431	ST-13529	8273267	CH06-14733	600-181-3800	CH14-12245	LA-1259	ST08-12229
AG132	CH-12246	LXS51	ST-16487	85352-1072	CH05-11106	600-181-4211	SC14-12254	LA1281	CH-12605
AG133	CH-12236	LXS61	ST-16880	85352-1073	CH05-11106	600-181-4212	SC14-12254	LA-132	CH-12206
AG136	CH-12091	SE045	ST-16488	853521198	CH08-11003	600-181-4230	SC14-12254	LA-134	CH05-11106
AG137	CH05-11106	SE046	ST-16880	K-6275	CH05-11106	600-181-4300	CH14-12245	LA-134F	CH05-11106
AG141	CH-12208	SE080	ST-13530	KOHLER		600-181-4311	CH14-12245	LA-135	CH08-12243
AG145	CH12-12251	SE081	ST-16876	A-249753	CH05-11106	600-181-4330	CH14-12245	LA-140	ST08-11110

Cross Reference by Manufacturer



MFRS. NO.	OUR NO.	MFRS. NO.	OUR NO.	MFRS. NO.	OUR NO.	MFRS. NO.	OUR NO.	MFRS. NO.	OUR NO.
LA-142	CH-12209	LA-608	CH-12273	LA-890F	CH08-12228	402-5156-400	SC-12274	8639028	CH06-14733
LA1434	CH-12225	LA-617	SC21-17075	LA-891	ST08-12229	402-5156-500	SC12-11391	865775	CH12-11389
LA1490	CH08-11942	LA-618	CH-12268	LA-905	CH-12286	51852110801	CH04-11675	8657795	CH12-11389
LA1491	CH-12485	LA-632	CH06-11056	LA-906	CH-12276	70000-11080	CH06-11038	8862651	SC12-11391
LA1500	CH-12491	LA-632F	CH06-11056	LA-907	SC10-11317	70000-11081	CH05-11106	9260261	CH05-11106
LA1526	CH-12716	LA-633	ST-12226	LA-913	CH-12231	70000-11221	CH04-11675	D600689	CH04-11675
LA1531	CH-12272	LA-641	CH14-13356	LA-915	PF-15684	70000-14500	CH06-11038	DO55379	CH-12397
LA1538F	CH06-11880	LA-642	SC14-13357	LA-946	CH-12215	76611-58420	CH04-11675	K-26046	CH14-12245
LA1553	CH-14722	LA-643	CH-12250	LA-948	CH-12216	KUKJE MACHINERY CO		LANDINI	
LA1584	CH06-11941	LA-643	CH-16874	LA-977	CH-12397	AE31724	ST-12226	3310357	ST06-12048
LA-161F	CH08-12221	LA-644	CH05-11467	LA-98	CH-12262	L B FILTERS		3310358	CH06-11880
LA1623	ST06-12048	LA-644F	CH05-11467	LA-981	CH-12225	A546	CH08-11288	3651225M91	PF-15890
LA1625	ST-14715	LA-649	CH-12209	LA-982	CH-12091	A634	CH-12213	VP125395	CH05-14409
LA1628	ST05-14980	LA-658	CH08-11288	LA-985	CH-12236	A650	CH-12210	LANSING-BAGNALL	
LA1638F	CH08-11003	LA-658F	CH08-11288	LA-986	CH-16873	A651	CH-13150	1041308	CH-12177
LA1765	ST-13529	LA-672	CH-12282	LA-992	ST-14343	A653	CH-12208	LANSING-LINDE	
LA-18	PF-14090	LA-675	ST08-11316	KRAMER		A654	CH-13157	000E068-019001	CH14-12245
LA-18	PFM-14095	LA-690F	CH08-11288	0000805187	CH07-14074	A658	CH-12826	1035364-001	CH-12209
LA-202	PF-15677	LA-691	ST06-11315	0009931106	CH-12397	A659	CH-12207	6646003-001	CH06-12258
LA-202B	PF-15677	LA-692	CH06-11295	KUBOTA		A660	CH-12207	E725047003	CH05-11106
LA-208F	CH-12275	LA-75	CH-12260	11420-11180	PF-15703	A662	CH-12260	LAUTRETTE	
LA-231F	CH08-11288	LA-755	ST09-12265	15104-11080	CH05-11106	A665	CH-12214	EL1165	CH-12262
LA-237	CH-12249	LA-76	CH-12208	15221-11223	CH04-11675	A666	CH-13156	EL1354	CH-12209
LA-249	SC14-12254	LA-77	CH-13157	15222-11220	CH04-11675	A683	SC12-11391	EL1357	CH-12209
LA-286	CH14-12245	LA-770	CH-12272	15222-11221	CH04-11675	A692	CH-12262	EL1684S	SC06-11252
LA-298	CH-12177	LA-773	CH-12271	15222-11223	CH04-11675	A698	CH12-12251	EL1780S	CH-12485
LA-315	CH-12212	LA-776F	CH10-11308	15222-11224	CH04-11675	A701	CH-12273	EL1781P	CH-13510
LA-325	CH14-12245	LA-777F	CH09-12244	15227-11221	CH04-11675	A702	SC-12274	EL1781S	CH-13520
LA-346	CH-11348	LA-78	CH-12214	15287-11080	CH05-11106	A711	CH14-12245	EL2106P	CH-12491
LA-361	CH-12269	LA-781F	CH08-12243	15287-11081	CH05-11106	A720	CH05-11106	EL2106S	CH-12485
LA-364	CH04-11675	LA-782F	CH05-11106	15319-11221	CH04-11675	A732	CH-12275	EL2107P	CH-12500
LA-364F	CH04-11675	LA-79	CH-13156	15321-11011	CH04-11675	A734	CH10-11308	EL2107S	CH-12279
LA-385	CH12-11389	LA-791	CH-12385	15321-11221	CH04-11675	A735	SC10-11317	EL2134P	CH-14340
LA-390	CH-12403	LA-80	CH-12207	15328-11221	CH04-11675	A783	SC-12270	EL2134S	CH-14334
LA-395	CH-12847	LA-812	CH-12980	15401-11080	CH05-11106	A819	CH-13141	EL2151P	CH-12498
LA-397	CH-12206	LA-813	CH-12386	15581-11081	SC-12274	A820	CH08-11288	EL3049	CH12-11389
LA-399F	CH05-12222	LA-814	CH-12232	15606-11080	CH06-11038	A821	ST08-11316	EL3051	CH12-12251
LA-421F	CH10-11308	LA-816	CH-12242	15606-96015	CH10-11308	A870	SC14-13357	EL3053	CH05-11106
LA-432	SC12-11391	LA-817	CH-12248	15612-11180	ST-14343	A891	CH-12272	EL3054	CH14-12245
LA-434	SC10-11317	LA-818	CH-12238	15741-11080	CH-12716	A899	CH-12271	EL3065	CH-12208
LA-435	SC-12274	LA-822	CH-12235	15741-11083	CH-12716	LACRE		EL3083	CH-12385
LA-437	SC-12270	LA-84	CH-12210	16271-11080	ST-16872	60441	CH05-11106	EL3084	CH-12235
LA-472	CH-14104	LA-85	CH-13150	17325-11080	CH05-11106	LANCER BOSS		EL3085	CH-12248
LA-538	CH-13141	LA-852	PF-14090	17351-11080	CH-12775	8619828	CH06-12258	EL3086	CH-12242
LA-549	SC10-12395	LA-852	PFM-14095	17351-11083	CH-12775	8620140	CH14-12245	EL3087	CH-12386
LA-573F	CH08-12221	LA-880	CH-12246	19215-11220	CH04-11675	8620159	CH05-11106	EL3089	CH-16873
LA-574	CH21-17070	LA-884	CH18-17230	19404-11081	SC-12274	8620167	CH06-12258	EL3090	CH-12213
LA-60	CH-12262	LA-885	SC18-17232	19458-8748-0	CH04-15145	8620204	CH08-11288	EL3091	CH-12250
LA-601F	CH06-14733	LA-890	CH08-12228	402-3152-300	CH12-11389	8620212	SC10-11317	EL3091	CH-16874

Cross Reference by Manufacturer



MFRS. NO.	OUR NO.	MFRS. NO.	OUR NO.	MFRS. NO.	OUR NO.	MFRS. NO.	OUR NO.	MFRS. NO.	OUR NO.
EL3304P	CH-12491	ABU8522	CH-12242	70002639	ST08-11316	9839012	CH-12397	LONG	
EL3304S	CH-12485	ABU8524	CH-12235	70005286	CH10-11308	9839014	CH-12231	739472	CH-12209
FA2100	PF-15672	ABU8525	CH-12385	70005287	SC10-12395	9839015	CH-12386	LORAIN	
LAVERDA		ABU8529	CH-12264	70005331	SC-12270	9839019	CH-12285	F-44516-X1	CH-12260
300137988	CH-12790	ABU8530	CH-11211	70005424	CH08-11288	9839331	CH05-11106	P-055591	CH12-11389
320651750	CH-12794	ABU8531	CH-12289	7000738	CH-12232	FM8104273	ST-13530	P-11913	CH12-12251
LEE		ABU8785	CH-12246	7008443	CH18-17230	LINK-BELT		P-55591	CH12-11389
AF-1031	PF-15684	ABU9670	CH14-12245	7009285	CH12-11389	1409265	CH08-12243	P-55596	CH12-11389
AF-300	PF-15684	ABU9896	CH-12276	7009286	SC12-11391	1410546	CH12-12251	P-55602	SC12-11391
AF-602	PF-15683	ACU2889	CH-12752	7010578	SC14-12254	1410903	CH05-11106	P-55605	CH14-12245
AFL-1031	PF-15684	ACU2915	CH-12781	701468	CH-12091	1410910	CH05-11106	P-55606	SC14-12254
AFL-160	PF-15684	ACU3426	CH14-12245	7360149	CH09-12244	1416129	CH08-12243	PO-11913	CH12-12251
AFL-575	PF-15683	ACU3994	CH-13050	7360150	ST09-12265	2087029	CH10-12224	LOSENHAUSEN	
LEROI		ACU7896	CH08-11288	7360230	ST08-11316	2341502	CH08-12243	04003/08015	CH-12397
220-099	CH05-11106	ACU8223	CH-12278	7360733	ST-13531	253053	CH08-12243	04021/19504	CH-12386
220-99	CH05-11106	ACU9896	CH-12276	7360753	CH-12385	33242237	CH12-12251	4022/19502	CH-12385
43-422	CH08-12243	BBU4784	CH08-11935	7360972	CH-12276	3H-218	CH12-12251	4022/19505	ST-13531
43-422-1	CH08-12243	BBU6548	CH-12247	7360973	SC10-11317	JLH100	CH08-11935	LOWE MACHINE	
43-493	CH05-11106	BBU6549	CH-12231	7361346	ST-13530	JLH101	ST08-11316	2699	CH-12262
43-493-1	CH05-11106	BBU6634	CH-12857	7361347	CH-12386	KRH0786	SC12-11391	LPM	
43-635	CH05-11106	BBU8346	CH-11211	7361355	CH-12266	LISTER PETTER		000-1350-4276	CH05-11106
43-635-1	CH05-11106	CRF508027	CH12-11389	7362587	SC14-12254	027-05419	CH05-11106	000-1350-4505	CH-12209
43-646	CH12-12251	RDK6220	SC14-12254	7362686	CH14-12245	027-05423	CH-12262	LUBERFINER	
X-43-422	CH08-12243	RTC3479	CH-12857	7362687	SC14-12254	027-05583	CH12-11389	AF-1031	PF-15684
LEYLAND		LIEBHERR		7363362	CH10-11308	194008	CH-12839	AF-1418	CH12-11389
10906043	CH12-12251	510 6181	CH-12235	7364869	CH18-17230	194009	CH-12206	AF-300	PF-15684
10906053	CH14-12245	510 6191	CH-12278	7364870	SC18-17232	194010	CH-12177	AF-602	PF-15683
10906079	CH12-11389	5106180	CH-12231	7367182	ST-13529	201-26010	CH-12206	AF7849	CH-12272
35516458	CH14-12245	5106182	CH-12386	7368215	ST-17470	289185	CH-12206	LAF-1246B	CH08-12243
37H2004	CH-12653	5106189	CH-12385	7370955	CH-16294	292364	CH-12839	LAF-1275	CH05-11106
37H3739	CH08-11288	5106368	CH12-11389	737095503	CH-16294	352-43820	CH-12177	LAF-1275B	CH05-11106
37H4920	CH-12209	5106509	CH-12238	7370956	SC-16301	36608105	CH05-14409	LAF-131	CH-12209
41007448	CH12-11389	5106525	ST-13530	7371156	ST10-15380	366-08109	CH07-14865	LAF-1394	ST08-11110
41008819	CH14-12245	5507989	CH08-11288	7371157	CH-16928	36608110	ST07-14270	LAF1466	CH06-11941
41017302	CH14-12245	5507991	CH14-12245	7401179	CH-12286	382-07903	CH-13404	LAF-15	PF-14090
41735724	CH12-11389	550799214	CH14-12245	7401316	CH09-12244	397079	CH05-11106	LAF-15	PFM-14095
735724	CH12-11389	5507994	CH18-17230	7402026	CH-13050	397305	CH04-11675	LAF-1544	CH08-11288
739472	CH-12209	5507995	SC18-17232	7402027	SC10-11317	6024-1760	CH05-11106	LAF-1711	ST-16488
AAU3669	CH-12839	560 1963	ST-13527	7405233	CH-12798	691-00108	CH14-12245	LAF-1712	CH-12231
ABU4557	CH16-12253	5600615	CH-12269	7412732	CH-16928	757-27890	CH-18672	LAF-1713	ST-16487
ABU6138	CH14-12245	5601964	CH-12242	7412733	ST10-15380	JF35/6	CH-12206	LAF-1714	CH-12386
ABU6151	SC12-11391	5604683	SC-12274	7615526	CH08-11942	JF35A/6	CH-12177	LAF-1715	ST-13530
ABU8506	CH-12262	6425549	CH10-11308	7619404	CH08-14410	ZPF35/6	CH-12839	LAF-1716	CH-12242
ABU8508	CH12-12251	6425550	SC10-11317	7619405	ST08-14413	LOCKWOOD		LAF-1717	ST-13527
ABU8516	PF-15680	6425723	CH12-11389	LINDE		085319	CH08-12243	LAF-1718	CH-12235
ABU8517	CH-12213	6425724	SC12-11391	000 983 9016	ST-16488	085328	CH05-11106	LAF-1719	ST-13529
ABU8518	CH-12660	7 367 183	CH-12235	0009839017	ST-16487	085329	CH05-11106	LAF-1720	ST-13531
ABU8521	CH-12250	70002402	ST-16487	983 9020	ST-13531	LOED CORPORATION		LAF-1721	ST08-11316
ABU8521	CH-16874	70002403	CH-12231	9831604	CH-12385	200-230	CH08-12243	LAF1722	CH06-11295

Cross Reference by Manufacturer



MFRS. NO.	OUR NO.	MFRS. NO.	OUR NO.	MFRS. NO.	OUR NO.	MFRS. NO.	OUR NO.	MFRS. NO.	OUR NO.
LAF-1723	ST06-11315	LAF4544	CH08-17365	LAF8579	CH-12653	LAF8822	CH10-14455	MA6720	CH-12236
LAF-1725	ST09-12265	LAF4545	ST08-14413	LAF8580	CH-12236	LAF8823	CH-12716	MA673P	CH-12213
LAF-1726	CH-12278	LAF-46	CH-13150	LAF8581	CH-12215	LAF8974E	CH-13075	MA674P	CH-12660
LAF1727	ST-13528	LAF-47	CH-12208	LAF8582	CH-12216	LAF8976E	CH-12790	MA684	CH-12235
LAF-1727	ST-13528	LAF-4714	PF-15677	LAF8583	CH08-11935	LAF8977E	CH-12794	MAK6693	CH05-11106
LAF1732	CH-12397	LAF-4747	CH08-12221	LAF8584	CH-13185	LAF8979E	CH12-11343	MAT 6702	CH-12397
LAF-1733	CH-12091	LAF-4759	CH-12289	LAF8589	ST-14787	LAF8979E	CH-13477	MAT-6684	CH-11211
LAF1734	CH06-11056	LAF-48	CH-13157	LAF8598	ST-14183	LAF8980E	CH-13190	M.A.N.	
LAF1735	ST-12226	LAF-5043	CH08-12221	LAF8601	CH-12238	LAF8991	CH-13763	08304.0024	CH-12234
LAF-1737	CH-12781	LAF-5054	CH-12275	LAF8602	CH-13811	LAF-9001	CH09-12244	35A255106	CH-12234
LAF1739	CH-13050	LAF-5054A	CH-12275	LAF8603	CH-13270	LAF-9085	SC-12274	50.08304.0003	CH10-11308
LAF-1741	CH-12285	LAF-5054B	CH-12275	LAF8604	CH-12250	LAF-9086	CH-12273	50.08304.0004	CH09-12244
LAF-1743	CH-11211	LAF-5368	CH08-11288	LAF8604	CH-16874	LAF-9200	CH-12269	50.08304.0005	CH14-12245
LAF-1747	CH-12283	LAF5859	CH-12752	LAF8605	ST-14183	LAF-9373	SC14-12254	555-08304-015	SC14-12254
LAF1750	CH-12387	LAF-6587	CH12-11389	LAF8606	CH-12485	LAF-9410	ST08-11316	81.08205.0005	CH-12235
LAF1763	CH-12246	LAF-6769	CH14-12245	LAF8607	CH-12491	LAF-9538	CH06-14733	81.08304.0023	CH-12238
LAF1764	CH-12247	LAF-6775	SC14-12254	LAF8608	CH-12498	LAF-9778	ST09-12265	81.08304.0024	CH-12234
LAF-1766	CH-12206	LAF-6834	SC12-11391	LAF8609	CH-11789	LAF9972	CH-13141	81.08304.0028	CH-12232
LAF1777	SC14-13357	LAF-7092	CH-12282	LAF8610	CH08-11942	LH8617	CH-12286	81.08304.0029	CH-12234
LAF-1793	ST-14343	LAF-7672	CH14-12245	LAF8611	CH-12500	LUCAS		81.08304.0032	CH-16873
LAF-1798	CH-12234	LAF-7781	SC21-17075	LAF8612	CH-12279	T-236	CH-11348	81.08304.0036	CH-12242
LAF-1826	CH-12403	LAF-7782	CH21-17070	LAF8613	CH-12302	T-402	CH-12216	81.08304.0038	CH-12278
LAF-1842	CH08-12221	LAF-7797	CH-12268	LAF8617	CH-12286	LUGLI		81.08304.0040	CH-12235
LAF1948	ST-13410	LAF8166	CH-13889	LAF8618	ST08-12229	2754234	CH08-11003	81.08304.0041	CH-12235
LAF-2052	CH-12385	LAF-8211	CH14-13356	LAF8619	CH08-12228	2754235	CH-13349	81.08304.0043	CH-12278
LAF-237	CH12-12251	LAF-8216	SC14-13357	LAF8623	ST-16879	M FILTER		81.08304.0044	CH-12278
LAF-237A	CH12-12251	LAF-8407	CH18-17230	LAF8625	CH-12177	MA6611P	CH-12385	81.08304.0045	CH-12242
LAF-2608	CH-11020	LAF-8408	SC18-17232	LAF8628	PF-15686	MA6618	CH-16873	81.08304.0046	ST-13527
LAF-265	CH-12262	LAF8503	CH-12980	LAF8635	CH-13824	MA6620	CH-12660	81.08304.0048	CH-12235
LAF-265HD	CH-12262	LAF-8513	SC-12270	LAF8649	CH-15300	MA6621P	CH-12250	81.08304.0049	CH-12385
LAF2736	CH-13157	LAF-8515	CH06-11941	LAF8651	CH-12825	MA6621P	CH-16874	81.08304.0050	SC14-12254
LAF-2745	CH04-11675	LAF-8517	CH06-12258	LAF8658	CH-14107	MA6622P	CH-12980	81.08304.0051	CH14-12245
LAF-2745A	CH04-11675	LAF-8525	ST06-11109	LAF8659	CH05-12222	MA6623P	CH-12232	81.08304.0053	CH-12386
LAF-281	CH05-11467	LAF-8526	ST06-11109	LAF-8662	CH10-11308	MA6628	CH-12283	81.08304.0054	CH-12386
LAF-290A	CH-12260	LAF-8529	CH-12857	LAF8664	CH-12798	MA6632P	CH-12209	81.08304.0055	CH-12385
LAF-334	CH-12214	LAF-8549	CH-12272	LAF8665	SC06-11252	MA6637P	CH-12242	81.08304.0057	CH-12235
LAF-335	CH-13156	LAF-8550	CH-12271	LAF-8668	CH10-11308	MA6643	CH-12264	81.08304.0058	SC-12252
LAF336	CH-13141	LAF-8557	CH-12283	LAF-8674	SC10-11317	MA6655	CH-12653	81.08304.0059	CH16-12253
LAF-3702	CH-16873	LAF8560	ST10-11239	LAF-8736	CH05-12222	MA6659	CH-12246	81.08304.0060	CH-12235
LAF-3703	CH-12232	LAF8561	CH10-11117	LAF8804	CH06-11880	MA6679	CH-12386	81.08304.0062	CH12-11389
LAF-3704	CH-12248	LAF8562	ST05-11108	LAF8809	CH-13090	MA6680	CH-12206	81.08304.0063	SC12-11391
LAF-3710	CH-12867	LAF8564	CH-12660	LAF8811	CH-13520	MA6681	CH-12249	81.08304.0065	ST-13529
LAF-3714	CH-12276	LAF-8567	CH-12225	LAF8814	CH-12239	MA6682	CH-12213	81.08304.0066	ST-17470
LAF-3715	CH-12264	LAF-8568	ST-16876	LAF8817	CH-13510	MA6683	CH-12289	81.08304.0083	CH-14900
LAF-378	CH-12207	LAF8569	CH-12302	LAF8818	CH-12770	MA6684	CH-11211	81.08304.0094	CH-14900
LAF-3951	PF-15677	LAF8570	CH-12213	LAF8819	CH-12605	MA6702	CH-12397	81.0830424	CH-12234
LAF-398	CH-14104	LAF8571	CH-12826	LAF8820	CH-12953	MA6708	CH-12177	81.08405.0008	ST-13527
LAF-45	CH-12210	LAF-8571	CH-12213	LAF8821	CH-12604	MA6709	CH12-11389	81.08405.0011	ST-13528
LAF4514	CH-12775	LAF8576	CH-12809	LAF8822	CH10-12390	MA6713	CH-12839	81.08405.0013	ST-13528

Cross Reference by Manufacturer



MFRS. NO.	OUR NO.	MFRS. NO.	OUR NO.	MFRS. NO.	OUR NO.	MFRS. NO.	OUR NO.	MFRS. NO.	OUR NO.
81.08405.0024	CH-12234	2MD-433	CH12-12251	LX31	CH-12268	4511455209	ST-16488	C16302	CH08-11288
81.54131.0001	CH-12953	57-MD-25	CH-12268	LX32	CH06-11295	4516555224	CH-12231	C16400	CH-16491
81.8304.0055	CH-12385	57-MD-310	CH-12268	LX33	CH09-12244	4516555239	ST-16487	C-1682	SC-12270
810.830.400.64	CH-12242	81-SD-25	CH12-12251	LX334	PF-15690	4522555229	ST-13530	C-17126	SC14-12254
81055040033	CH-12238	MACO-MEUDON		LX47	CH-12213	4522592304	CH-12386	C17134	CH-12091
81083040039	CH-12238	025221	CH12-12251	LX83	CH-12809	4532592304	CH-12385	C17149	SC14-12254
81083040074	CH-14107	520730	CH08-11288	LX84	CH-11211	4544092304	CH-12242	C17201	CH-12285
81083040076	CH-14107	520731	ST08-11316	LX93	CH-12283	4544092664	CH-12242	C17225	CH-12980
81083040083	CH-14900	520837	CH12-11389	LX99	CH-12285	4565092304	CH-12235	C17225/2	CH-12386
81-08304-0097	CH-14900	520942	CH06-11295	LXS19	CH-13157	4588092304	CH-12278	C17225/3	CH-12386
8183040040	CH-12235	520943	ST06-11315	LXS201	SC12-11391	C 11 100	CH-16878	C17250	CH-12225
86.08304.4001	CH-12234	521542	CH09-12244	LXS212	ST06-11315	C 1131	CH-13115	C17337	CH08-14410
90.80115.5196	CH-12234	521745	CH10-11308	LXS214	ST08-11316	C 1132	CH-17512	C18288	CH-12275
A5008340004	CH09-12244	528052	CH10-12390	LXS25	SC14-12254	C 1368	CH-13116	C18436	CH09-12244
M.T.U.		528052	CH10-14455	LXS30	SC10-11317	C 1633/1	CH-14950	C19157	SC-12252
001 094 5104	CH-12235	MAHLE		LXS34	ST09-12265	C1112	CH-12953	C1989/1	CH-15788
869 094 0013	CH21-17070	LX102	CH-12264	LXS37	ST-13531	C1140	CH-17541	C-20215	SC-12274
869 094 0430	CH-12385	LX116	CH-12208	LXS40	ST-16488	C1176/3	CH-12397	C20325	CH-12232
8690940	CH-12278	LX13	CH04-11675	LXS41	ST-13530	C1188	CH05-11106	C20325/2	CH-12385
M.W.M.		LX14	CH05-11106	LXS42	ST-13527	C12100	SC10-11317	C20500	CH-16492
011806560005	CH16-12253	LX15	CH-12209	LXS43	ST-13529	C-12100/1	SC10-11317	C20550	CH-12286
011807490001	CH12-12251	LX155	CH-12249	LXS44	ST-13528	C12114	CH-12209	C20855	CH-12289
605412970031	CH-12980	LX174	CH-12177	LXS62	ST-16876	C-12119	CH-12209	C20855/1	CH-12289
605412970032	CH-12386	LX179	CH-11789	MANITOU		C1250	CH-17542	C21338	CH-12236
605412970033	CH-12232	LX18	CH08-11288	169468	CH05-11106	C-1258	SC12-11391	C21431	CH10-11308
605412970034	CH-12385	LX192	CH-12953	169470	SC12-11391	C1281	SC12-11391	C21630/1	CH-16928
605413900006	CH05-11106	LX196	CH-12091	169471	ST08-11316	C13131	CH-13644	C21925	CH-12826
606901670110	CH-12278	LX21	CH12-12251	169472	CH08-11288	C13135	CH-12287	C-22150	CH-12216
606901670111	ST-13528	LX22	CH-12212	169473	CH-12653	C1371	CH-13157	C22224	CH-12213
606901670113	CH-12386	LX227	CH-12242	169476	CH12-11389	C1392	CH-12870	C-22300	CH-12207
606901670114	ST-13530	LX231	CH-12248	169478	CH12-12251	C14079	CH04-11675	C23326	CH-12208
606901670115	ST-13531	LX236	CH-12386	169479	CH10-12224	C1417	CH-15696	C23440/1	CH-12242
606901670116	CH-12385	LX240	CH-12234	169481	CH-12231	C14179/1	CH06-11056	C23440/2	CH-12248
MACDON		LX241	CH-16873	169483	CH-12397	C14190	CH06-11295	C23440/3	CH-12242
30049	CH06-14733	LX242	CH-12980	169487	CH-12386	C1426	CH-11348	C23500	CH-12234
MACK		LX243	CH-12232	177129	CH-13824	C14490	CH06-11295	C23610	CH-16881
2191-P-10-0890	CH-12262	LX263	CH-12246	177130	CH-13811	C15127/1	CH-11789	C24355	CH-12239
2191-P-10-1203	CH-12262	LX265	CH-12385	177178	ST-15557	C15165/1	CH-12231	C24393	CH-12825
2191-P-10-1237	CH12-12251	LX268	CH-12247	177179	ST-14183	C15165/3	CH-12231	C-24444	CH-12208
2191-P-10-2090	CH-12260	LX269	CH-12236	185578	CH-13818	C15248	CH-12809	C24444/1	CH-12208
2191-P-11-7797	CH-12268	LX27	CH10-11308	227959	CH07-14865	C15300	CH-16490	C24508	CH-14107
2191-P-17064	CH-12262	LX271	CH-12235	227960	ST07-14270	C-1565	CH-12215	C24516	CH12-12251
2MD-2133	CH12-12251	LX272	CH-12397	448037	CH08-11288	C16140	CH-13156	C24517	CH12-11389
2MD-2159	CH-12268	LX273	CH-12278	455044	CH06-11295	C16147	CH-13141	C24650	CH-16873
2MD-3156	CH-12268	LX274	CH-12238	563415	ST08-14708	C16153	CH-12212	C24650/1	CH-12235
2MD-3156-P1	CH-12268	LX275	CH-12231	563416	CH08-14703	C16154	CH08-12221	C24700/1	CH-12238
2MD-352	CH-12262	LX28	CH12-11389	9865	CH05-11106	C-16175	CH-13150	C24719	CH12-11389
2MD-354	CH-12262	LX28	CH-12246	MANN & HUMMEL		C16190/1	CH08-12243	C24813	CH-15300
2MD4122	CH-12268	LX29	CH14-12245	4510054134	CH-13835	C16247/1	CH-14387	C24870	CH-12276

Cross Reference by Manufacturer



MFRS. NO.	OUR NO.	MFRS. NO.	OUR NO.	MFRS. NO.	OUR NO.	MFRS. NO.	OUR NO.	MFRS. NO.	OUR NO.
C25710/3	CH-16969	CF500	ST-16496	1093683-M92	ST08-11316	2874154-M1	CH12-11389	IS153	CH-12209
C26315/4	CH-12660	CF600	ST-16488	1093686-M91	ST08-11316	2874165-M1	CH-16873	IS164	CH12-11389
C271406	CH-11211	CF610	ST-16875	1096416-M91	CH16-12253	2874186-M1	SC12-11391	IS166	CH-12235
C271520	CH-11211	CF700	ST-16487	1096417-M91	SC-12252	2879154-M1	CH12-11389	IS177	CH-12385
C-27836	CH-12269	CF710	ST-16970	1096475-M91	ST09-12265	3072893-M1	CH08-11288	IS187	CH-12283
C2860	PF-15684	CF711	ST-16880	1097001-M91	CH-12266	3074304-M1	CH-12286	IS190	CH-12242
C28715	CH-12246	CF800	ST-13530	1420740-M91	CH08-11288	3074305-M1	CH-12276	IS193	CH-12212
C28750	CH-12798	CF810	ST-16972	1428739-M91	CH06-11295	3074307-M1	ST09-12265	IS196	CH-12264
C29 624/1	CH-12214	CF811	ST-16876	1428745-M91	CH10-11308	3074308-M1	SC10-11317	IS207	CH-11211
C291055	CH-15294	CF820	ST-16879	1428747-M91	SC10-11317	3252001-M1	ST-16488	IS210	CH-12236
C-29624	CH-12214	CF821	ST-16879	1428748-M91	CH08-11288	3281825-M1	CH04-11675	IS214	CH-12386
C-29776	CH-12210	CF840	ST-12226	1429717-M91	CH10-11308	3310354-M1	ST06-12048	IS219	CH-12289
C-29920	CH14-12245	CF922	ST08-11316	1429718-M91	SC10-11317	3310355-M1	CH08-11935	IS244	CH-12206
C29939	CH14-12245	CF923	ST06-11315	1433650-M92	ST08-11316	3310357-M1	ST06-12048	IS248	CH-12397
C301240	CH-14896	CF924	ST08-11110	1435408-M92	CH-12240	3310358-M1	CH06-11880	IS74	CH-12213
C301353	CH-14900	CS18106	CH-13939	1621646-M91	CH06-11295	3385733-M1	CH-14237	IS75	CH-12660
C301500	CH-14902	CS19175	CH-13889	1633719-M1	CH-14334	3388840-M2	PF-15891	IS91	CH-12826
C30703	CH-12387	CS19195	CH-13190	1635988-M91	CH-12485	3389792-M2	CH-12794	MATBRO	
C30810/3	CH-16971	LA1434	CH-12225	1635989-M91	CH-12498	3438717-M1	ST-14343	31020/003	ST08-11110
C30850/2	CH-12278	MARSHALL FOWLER		1644-333-M1	CH-14334	3580723M1	CH-12794	P14314/1	CH08-11003
C30880/1	CH-12264	2811070	CH05-11106	1644334-M1	CH-14340	3595519-M1	ST06-12048	P7271/1	CH05-11106
C31 1256	CH-15304	9007613	CH08-12228	1678294-M1	CH-12491	3621275M1	CH06-14733	MAZDA	
C311093	CH-12283	900785	ST08-12229	1678295-M1	CH-12485	3621282M1	CH08-11288	1391-23-603	CH-12215
C311093/1	CH-12283	MASSEY-FERGUSON		1678296-M1	CH-12491	3621283M1	ST08-11316	MCCORMICK	
C311093/2	CH-12283	1026131-M91	CH-12209	1678308-M91	CH-12498	3621284M1	CH06-11941	248124A1	PF-16185
C311226	CH16-12253	1026131-M92	CH-12209	1698375-M1	SC06-11252	3902806M1	CH-16969	708962A1	PF-16591
C311226/1	CH-15300	1026161-M91	CH-12209	1698675M2	CH-13510	3902812M1	ST-16970	MEADOWS	
C311495	CH-16922	1026191-M91	CH-12209	1698676-M1	CH-13520	506645-M91	CH08-12243	15A-339	CH05-11106
C31220	CH-12249	1031436-M91	CH05-11106	1698679-M1	CH-12491	513605-M91	CH05-12222	15A-739	CH05-11106
C331476	CH-13763	1031885-M1	CH12-12251	1698680-M1	CH-12485	525611-M91	CH12-11389	15H-665	CH05-11106
C331605	CH-12282	1031885-M91	CH12-12251	1699779-M1	CH-12491	525612-M1	SC14-12254	15H-668	CH05-11106
C33922	CH-12247	1032762-M91	CH05-12222	1699780-M1	CH-12485	525612-M91	SC12-11391	MELROE	
C34430	CH-12250	1037735-M91	ST06-11315	1804507-M91	CH04-11675	579873-M1	CH05-11106	15A-339	CH05-11106
C34430	CH-16874	1040764-M91	CH06-14733	1807257-M1	CH-12209	6191362M1	CH04-14412	15A-739	CH05-11106
C45 3265	CH21-17070	1040830-M91	CH12-11389	1866048-M92	CH08-11288	723360-M91	CH08-12243	15H-665	CH05-11106
C60148	PF-15688	1040919-M91	SC12-11391	1886670-M1	CH-14237	726199-M1	CH08-11288	15H-668	CH05-11106
C60230	PF-15690	1042412-M91	CH09-12244	1897151-M1	CH-12209	7277153200	CH-14237	6646494	CH05-11106
C60345	PF-15693	1043327-M91	ST-14343	194196145	CH-12232	880271-M1	CH-12209	6666376	ST07-14270
C630	CH-17539	1055493-M91	CH06-11056	19746201	CH-16873	CL677434-C0	CH-12385	MENARINI	
CF100	ST-16877	1055494-M91	ST-12226	197946201	CH-16873	TDX-27493	CH05-11106	178624	SC14-12254
CF1000	ST-13531	1062501-M91	CH08-11942	19796201	CH-16873	TRA8273234	CH05-11467	178625	CH14-12245
CF1122	ST09-12265	1070329-M91	CH06-11056	240737-M91	CH08-12243	TRA8273235	ST-13410	MENGELE	
CF1200	ST-13527	1073508-M91	ST-12226	246918-M91	CH05-11106	TRA8273267	CH06-14733	98026633	CH-12242
CF1300	ST-13529	1089774-M91	CH14-12245	258522-M91	ST08-11316	MASTE		98029974	ST-13527
CF1600	ST-13528	1089937-M91	SC14-12254	258541-M91	CH08-11288	IS124	CH-12980	98039890	CH-12278
CF200	ST-16493	1090109-M91	CH12-11389	273572-M91	CH09-12244	IS126	CH-12232	98039927	CH-12235
CF2100	ST-17470	1090110-M91	SC12-11391	273743-M91	ST09-12265	IS129	CH-12250	98039928	ST-13529
CF300	ST-16494	1093682-M91	CH08-11288	2868515-M1	CH-12232	IS129	CH-16874	98041118	ST-13528
CF400	ST-16495	1093683-M91	ST08-11316	2874126-M1	CH12-12251	IS152	CH-16873	MERCEDES-BENZ	

Cross Reference by Manufacturer



MFRS. NO.	OUR NO.	MFRS. NO.	OUR NO.	MFRS. NO.	OUR NO.	MFRS. NO.	OUR NO.	MFRS. NO.	OUR NO.
0010944204	CH-12385	AC74735	CH10-11308	477220-12810	CH12-11389	EFA300	CH05-11106	FA-296	CH-12273
0010944604	CH-12386	AC7486	CH14-12245	52402-00100	SC-12274	EFA304	CH-12231	FA-508	CH-12262
0010944704	CH-12242	AC7489S	CH06-11038	60608-00800	CH14-12245	EFA306	CH08-11288	FA-524	CH-12208
0010945204	CH-12385	AF2771	CH-12273	6072-2214-00	CH10-12224	EFA307	CH-12980	FA-525	CH-13157
0010946504	CH-12236	MILLER ELECTRIC		61908-00100	SC14-12254	EFA308	CH-12386	FA-534	CH-12260
0010947904	CH-12235	017309	CH05-11106	62608-00200	CH14-12245	EFA309	CH09-12244	FA-536	CH-12207
0010948004	CH-16873	018765	CH05-11106	64320-10415	SC-12274	EFA310	CH-12232	FA-564	CH10-11308
0010948204	CH-12231	025092	CH08-12243	66602-01800	CH10-11308	EFA311	CH-12385	FA-565	CH12-11389
0010948304	CH-12247	MIOFILTRÉ		66602-03700	SC10-11317	EFA313	CH-12213	FA-601	CH-12268
0010949304	CH-12246	20051	CH05-11106	91261-00700	CH05-11106	EFA315	CH-12242	FA-616	CH-13141
0010949404	CH-12236	20053	CH12-12251	9-126100700-0	CH05-11106	EFA316	CH-12248	FA-619	CH-12177
0010949604	CH-12980	20055	CH12-11389	91261-10110	CH05-11106	EFA317	CH12-12251	FA-631	CH14-13356
002 094 94 04	PF-15690	20060	CH-12232	91461-00500	CH05-11106	EFA318	CH-16873	FA-632	SC14-13357
0020940004	CH-12385	20061	CH-12385	9186100700	CH-12272	EFA319	CH-12235	FA-648	CH-12273
0020943304	ST-16487	20063	CH-12248	AE-063150	CH14-12245	EFA320	CH-12238	FA-663	ST06-11315
0020943404	CH-12231	20064	CH-16873	AE-063155	SC14-12254	EFA321	CH-12660	FA-735	CH-13157
0020946004	CH-12386	MITSUBISHI		MD-620563	CH-14211	EFA323	CH-12264	FA-738	CH09-12244
0020946104	ST-13530	30030-83100	SC12-11391	ME-033617	CH10-12224	EFA324	CH-12247	FA-740	PF-15677
0020947004	CH-12809	30030-84100	CH10-11308	ME-060219	CH10-12224	EFA325	CH-12246	FA-752	PF-15684
0020949204	PF-15690	30030-84200	SC10-11317	ME-063874	CH14-12245	EFA327	CH14-12245	FA-756	CH21-17070
0020949304	PF-15693	30630-56800	CH05-11106	ME-063879	CH10-11308	EFA328	CH-12278	FA-772	CH-12272
0030010948304	CH-12247	31130-01312	CH10-12224	MM510109	CH04-11675	EFA329	CH-12283	FA-779	CH-12282
0030943904	CH-11789	31130-02300	CH10-12224	MZ311786	CH-14211	EFA330	CH-11211	FA-798	CH-12206
0030946004	CH-14107	31130-02900	CH10-11308	MOHAWK MFG.		EFA333	PF-15680	FA-805	SC21-17075
0030947504	PF-15699	31130-16400	CH12-11389	86083044001	CH-12234	FA-1010	ST08-11110	FA-810	CH08-11288
0090940502	CH-12278	31230-02112	CH10-11308	MOPAR		FA-1013	ST-13410	FA-816	CH05-11467
0120948402	CH-12236	31230-02900	CH10-11308	L-151	PF-14090	FA-1031	PF-15684	FA-822	CH06-14733
0120948702	CH-12235	31230-12700	CH14-12245	L-151	PFM-14095	FA-124	CH-12262	FA-836	CH-12268
0130941502	CH-12246	31230-80500	SC14-12254	L-422	CH12-12251	FA-130	CH12-12251	FA-837	CH06-11056
0130941702	CH-12242	31230-84800	CH14-12245	L-575	PF-15683	FA-132	CH05-11106	FA-90	CH14-12245
0130941802	CH-12385	31930-35100	CH12-12251	MORBARK		FA-136	CH-12210	FA-931	ST-14343
344094710494	CH-12232	32143-04100	CH12-11389	29234-527	CH06-14733	FA-137	CH-13150	FA-949	PF-15683
344094730494	ST-13531	32143-05300	SC14-12254	29321-022	ST08-11110	FA-138	CH-12214	FA-954	CH05-11106
3760947104	CH10-11308	32143-06500	SC12-11391	29321-211	SC-12252	FA-139	CH-13156	FA-991	CH04-11675
61100190020	ST-13530	32143-06800	CH10-11308	29321-212	CH16-12253	FA-150	CH-12275	MOTORI VM	
61200190033	ST-13531	341021-11120	SC12-11391	29321-218	ST08-11316	FA-157	CH04-11675	4113006	CH08-11288
8690940020	CH-12278	341021-11140	CH12-11389	29321-219	CH08-11288	FA-158	SC12-11391	4113007	CH10-11308
A001 094 79 04	CH-12235	34530-01030	SC-12274	29321-255	CH18-17230	FA-176	CH08-11288	4113008	CH06-11295
MERCURISER		34530-02300	SC-12274	29321-256	SC18-17232	FA-185	SC14-12254	4113009	ST06-11315
15A-339	CH05-11106	34530-02300E	SC-12274	MOTOR COACH		FA-186	CH05-12222	4113026	ST08-11316
15A-739	CH05-11106	38610107	CH04-11675	9C-3-107	CH08-12243	FA-188	CH12-11389	4113027	SC10-11317
15H-665	CH05-11106	45740-70111	CH-12207	9M-3-21	CH-12260	FA-190	SC-12274	4113705	CH14-12245
15H-668	CH05-11106	45740-70210	CH-12214	MOTORCRAFT		FA-211	SC10-12395	MOTRIX	
MICRO PORE		45740-70510	CH-12208	EFA120	CH-11348	FA-232	CH08-12221	MA3660	PF-15684
A2770	CH10-12224	47220-12012	CH12-11389	EFA152	CH-11348	FA-233	SC10-11317	MAK271	PF-15683
A2771	CH-12273	47220-12820	SC12-11391	EFA225	CH06-12258	FA-235	CH-12269	MOXY	
A5619A	CH12-11389	47220-22810	SC14-12254	EFA228	CH-12397	FA-247	CH-12209	151570	SC14-12254
A5619B	SC12-11391	47220-22820	CH14-12245	EFA234	CH12-11389	FA-270	CH-14104	151571	CH14-12245
A5620B	SC14-12254	47220-24800	CH14-12245	EFA264	CH12-11389	FA-295	SC-12270	MUIR HILL	

Cross Reference by Manufacturer



MFRS. NO.	OUR NO.	MFRS. NO.	OUR NO.	MFRS. NO.	OUR NO.	MFRS. NO.	OUR NO.	MFRS. NO.	OUR NO.
265247	CH-12262	2595	PF-15677	6414	CH-12248	106769	CH14-12245	70104-N	SC10-11317
MULTIPART		2608	CH-12235	6430	CH-12231	106775	SC14-12254	70108-N	CH08-12221
TC3181	CH06-12258	2609	ST-13529	6466	CH08-12228	106834	SC12-11391	70113-N	SC-12274
MURPHY		26120	PF-15683	6467	ST08-12229	107868	CH08-11288	70114N	CH-12273
26814	CH-12266	2618	CH-12268	6487	CH08-12228	108668	CH10-11308	70120-N	CH-12282
MD-26814	CH-12266	2630	CH-12177	6496	CH-12716	108674	SC10-11317	70121-N	SC21-17075
MD-38-82	CH12-11389	2631	CH06-11056	6498	CH-12491	109085	SC-12274	70125-N	CH21-17070
MD-38-83	SC12-11391	2632	ST-12226	6502	CH-14722	109200	CH-12269	70129-N	SC14-13357
MDA-38-23	CH12-12251	2645	CH04-11675	6504	CH-14334	109206	SC-12270	70172-N	CH18-17230
MUSTANG MFG.CO.		2653	CH06-12258	6510	CH-12225	113538	CH06-14733	70181-N	CH12-12251
420-34599	CH05-11467	2656	CH14-13356	6515	CH-12386	114747	CH08-12221	70189-N	CH-14104
42035886	ST07-14270	2657	SC14-13357	6517	ST-13410	117092	CH-12282	70194-N	CH06-11056
NAPA		2679	ST06-11315	6522	ST08-11316	117781	SC21-17075	70198-N	CH-12260
2042	PF-14090	2710	CH-12839	6525	ST-13531	117797	CH-12268	70203-N	SC10-11317
2042	PFM-14095	2764	CH-12262	6526	CH06-11941	118158	CH-12262	70206-N	CH05-11106
2045	CH-12210	2769	ST-14343	6532	ST-13530	118216	SC14-13357	70220-N	CH-12249
2046	CH-13150	2811	CH-12206	6534	CH-12867	119410	ST08-11316	70226-C	CH05-11106
2047	CH-12208	2868	CH08-11288	6537	CH08-12228	119538	CH06-14733	70237-N	CH14-12245
2048	CH-13157	2878	CH-12249	6538	ST08-12229	120281	CH05-11467	70250N	CH05-11467
2119	CH12-11389	2890	CH-12262	6541	CH-12242	128407	CH18-17230	70251-N	CH-13156
2123	CH05-12222	2918	CH-14104	6546	CH-12232	130771	CH-14104	70252-N	CH-13150
2133	PF-15684	2919	CH10-11308	6547	CH-12283	131346	CH06-11056	70254-N	CH-12207
2142	CH08-11003	2920	SC10-11317	6554	CH-12385	131350	SC10-11317	70258-N	CH-12210
2208	CH14-12245	2921	SC10-12395	6560	ST09-12265	136390	CH-12209	70259-N	CH-13141
2209	SC14-12254	2924	SC12-11391	6561	CH-12286	136399	CH-12212	70261-N	CH-12208
22133	PF-15684	2927	CH-12269	6569	ST08-14413	145700	CH14-12245	70269-N	SC14-12254
2225	CH-12273	2928	SC-12270	6580	PF-14090	2S1285	CH-13157	70293	CH06-14733
2226	SC-12274	2966	CH-12268	6580	PFM-14095	2S1286	CH-13156	70293-N	CH06-14733
2237	CH12-12251	5295	CH-12273	6594	CH-12234	2S1287	CH-13150	70301-N	CH10-11308
2238	CH21-17070	6120	PF-15683	6606	CH06-11295	4M9334	CH-12214	70302N	CH09-12244
2239	SC21-17075	6133	PF-15684	6613	CH-13270	4M9378	CH-12207	70333	ST08-11316
2258	CH18-17230	6188	CH-12206	6625	CH08-11942	4N0015	PF-14090	70333N	ST08-11316
2259	SC18-17232	6210	CH-12847	6642	CH-12276	4N0015	PFM-14095	70334	CH08-11288
2276	CH05-11106	6263	ST05-14980	6643	SC10-11317	6L4714	PF-15677	70334N	CH08-11288
2290	CH-12260	6270	CH04-11675	6652	CH07-14074	70060-N	CH-12269	70338-N	ST08-11316
2321	CH08-11288	6274	CH-12215	6741	CH-12278	70062-N	CH-12209	70344N	ST-14343
2334	CH-12214	6294	CH-12091	6852	CH-12289	70063-N	CH14-12245	70367	ST06-11315
2335	CH-13156	6304	CH05-12222	6868	CH-11020	70067-N	SC12-11391	70367N	ST06-11315
2336	CH-13141	6313	CH-12397	7047	CH10-12224	70070	CH12-11389	70398-N	CH-12268
2342	CH-12272	6327	CH-12272	7048	SC-12252	70070-N	CH12-11389	70410N	ST09-12265
2378	CH-12207	6328	CH-12247	7052	CH16-12253	70071-N	SC-12270	70413-N	CH-12214
2489	CH05-11467	6330	CH-12285	NATIONAL MINE		70072N	CH-12266	70415-N	CH-13157
2503	CH08-12221	6351	CH-12213	64071475	CH12-12251	70077	CH14-13356	70482N	CH05-12222
2505	CH-12209	6352	CH-12403	NELSON/WINSLOW		70077N	CH14-13356	70497N	ST-13410
2508	CH-12282	6360	CH05-11106	100890	CH-12262	70089-N	CH-12262	70515N	ST08-11110
2518	CH06-14733	6375	ST08-11110	101237	CH12-12251	70098	CH04-11675	70517N	ST-12226
2522	CH09-12244	6378	CH-12605	101275	CH05-11106	70098N	CH04-11675	70530N	CH-12491
2540	CH-12275	6407	ST-14715	102090	CH-12260	70101-N	SC12-11391	70588-S	CH-12215
2550	CH-12209	6408	CH-12485	106587	CH12-11389	70102-N	CH08-11288	70591-S	CH-12216

Cross Reference by Manufacturer



MFRS. NO.	OUR NO.	MFRS. NO.	OUR NO.	MFRS. NO.	OUR NO.	MFRS. NO.	OUR NO.	MFRS. NO.	OUR NO.
70594-S	CH-12250	84826-S	CH09-12244	1930349	CH-14380	16546-96003	CH10-11308	140-P765	CH05-11106
70594-S	CH-16874	84839-S	CH-12289	59133	CH06-14733	16546-96010	SC12-11391	140P-842	CH04-11675
70595-S	CH-11348	84857-S	PF-15683	614103	CH14-13356	16546-96011	CH12-11389	185-2090	CH04-11675
70597-S	CH-12839	84864-S	CH-12781	614104	SC14-13357	16546-96014	SC14-12254	ONAN HOUSINGS	
70603-S	PF-15677	84874-S	CH-12234	79043778	CH12-11389	16546-96015	CH10-11308	140-P1248	CH04-11675
70604-S	CH-12231	84877-S	CH-12980	80748274	CH-12278	16546-96016	CH12-11389	ORENSTEIN & KOPPEL	
70605-S	CH-12091	84878-S	CH-12278	81868102	PF-15701	16546-96026	CH10-11308	0788422	CH-12235
70608-S	CH-12264	84880-S	CH-12238	81869555	ST-14715	16546-96027	CH12-11389	101158	CH-13074
70609-S	ST09-12265	84894-S	ST-13410	82001780	ST-17092	16546-96028	CH10-11308	101212	CH08-11942
70611-S	CH08-12228	84902-S	CH-12867	82001820	ST-17103	16546-96029	CH12-11389	1102149	CH08-11288
70612-S	ST08-12229	84905-S	ST-12226	82003726	CH-14722	16546-96060	CH12-12251	124909	CH10-11308
70615-N	ST06-11315	84906-S	ST-13531	82003739	ST-14715	16546-96125	CH14-12245	1408296	CH-12273
70617-N	CH05-11467	84907-S	ST-13527	82004413	ST-17092	16546-97009	CH12-11389	1408297	SC-12274
70627N	CH-12403	84908-S	ST-13530	82008597	ST-17092	16546-97015	CH12-11389	1415870	ST-13529
70819N	SC10-12395	84909-S	ST-13529	82008600	CH-14722	16546-99015	SC-12274	1416434	ST-13527
70831N	CH-12276	84911-S	CH06-12258	82008601	ST-14715	16546-99204	ST06-11109	1426098	CH-12276
70849N	CH-12286	84925-S	SC06-11252	82008607	ST-17103	16546-Z5001	CH10-12224	1447316	CH-11211
70868N	CH-12605	84966-S	SC10-12395	82011402	CH-14722	16546-Z5003	SC10-12395	1448074	CH-12247
70903N	CH-12485	84971-S	CH-12206	82034441	ST-17103	16546-Z5004	CH10-11308	1448075	CH-12246
70954N	CH05-15887	84975-S	CH-12177	82981152	CH08-17365	16546-Z5025	CH10-11308	1448081	CH08-11288
7M9045	CH-12210	84978-S	CH-12213	84030107	CH-16294	16546-Z5026	CH10-11308	1448534	CH14-12245
83627-A	PF-15677	84982-S	CH-12660	86504143	ST-14343	NKK		1448535	CH16-12253
83627N	PF-15677	84983-S	CH-12385	86519866	CH05-15887	4F1007F	CH10-11308	1448987	PF-15686
83722N	CH-12847	84987-S	CH-12204	86529587	CH08-12228	4ID1008F	CH12-12251	1448989	CH05-11106
83893-N	PF-14090	84988-S	PF-15680	89811231	ST-13528	OM		1449408	CH-12208
83893-N	PFM-14095	84990-S	CH-12248	89835746	ST-17470	9819406	CH05-11106	1449409	CH-13157
84285N	PF-15683	84991-S	CH-12386	9702158	CH06-14733	OMNI EQUIPMENT		1449410	ST06-11109
84611-S	CH05-12222	84992-S	CH-12235	9811231	ST-13528	0003633631	CH-12285	1449429	ST-16487
84655-S	CH14-13356	84994-S	CH-12653	NIPPON		0009931106	CH-12397	1449527	CH14-12245
84670-S	CH-12271	84996-S	CH-12397	A-2770S	CH10-12224	ONAN		1449640	CH-12953
84671-S	CH-12272	84999-S	CH-12242	AC-7472	CH10-12224	140-0765	CH05-11106	1450012	CH-12282
84682-S	CH06-11295	9S9972	CH-13141	AC-7472S	CH10-12224	140-1248	CH04-11675	1450231	CH09-12244
84686-S	CH-12275	W-6L-4714	PF-15677	AC-7473	CH10-11308	140-1251	CH04-11675	1450585	CH-12214
84698-S	CH-12283	NEM		AC-7473S	CH10-11308	140-1540	CH06-14733	1450586	CH-13156
84699-S	CH-12826	NE6003	CH14-12245	AC-7473S	CH10-11308	140-1617	CH10-11308	145142	PF-14090
84700-S	CH-16873	NE625S	CH10-11308	AC-7486	CH14-12245	140-1618	SC10-11317	145142	PFM-14095
84705-S	CH-12247	NEUSON		AF-2771	CH-12273	140-1619	CH08-11288	1451794	SC10-12395
84706-S	CH-12246	1211071	CH04-11675	AV-5612	CH10-12224	140-1620	ST08-11316	1454260	SC14-12254
84708-S	CH-12236	4505514	ST-14343	WA-8537	CH-12215	140-1621	CH09-12244	1455283	CH-12604
84713-S	CH-12285	5005004	CH05-11106	NISSAN		140-1622	ST09-12265	1455327	CH-12605
84714-S	CH-12225	5005028	ST05-14980	16506-96015	CH10-11308	140-1851	CH05-11467	1457866	CH-12271
84718-S	CH-11020	NEW HOLLAND		1654602K00	CH-12870	140-1932	CH10-12224	1457867	CH-12272
84721-S	CH-12232	0922214	PF-15688	165461G000	CH-13644	140-2328	CH04-11675	1457879	CH-12210
84723-S	SC18-17232	151849501	CH06-11255	16546-25004	CH10-11308	140-2762	CH-12867	1463932	CH-13141
84724-S	CH-11211	151849502	SC06-11269	16546-86017	CH14-12245	140-3119	CH06-16050	1471158	CH-16294
84730-S	CH-12752	1909116	CH08-12228	16546-90204	SC-12274	140P-1002	PF-14090	1471159	SC-16301
84731-S	CH-12212	1930138	CH-14533	16546-95001	CH12-12251	140P-1002	PFM-14095	1476636	CH-14900
84766-S	CH04-11675	1930174	CH12-11343	16546-95003	CH12-12251	140-P1251	CH04-11675	1499654	ST-13528
84824-S	CH08-11288	1930174	CH-13477	16546-95010	ST09-12265	140-P721	CH05-11106	1499655	ST-12226

Cross Reference by Manufacturer



MFRS. NO.	OUR NO.	MFRS. NO.	OUR NO.	MFRS. NO.	OUR NO.	MFRS. NO.	OUR NO.	MFRS. NO.	OUR NO.
1499661	ST-16488	773605	CH-12385	AI-3129	CH-12249	AI-3352	CH-12397	691.031	ST09-12265
1499681	CH-12250	776604	ST-13531	AI-3203	CH-12214	AI-3357	ST-13530	691.351	CH-12385
1499681	CH-16874	8003742	ST-13530	AI-3205	CH-12207	AI-3358	CH-12278	698089	CH-12235
1499695	CH-12278	8003751	CH-12235	AI-3206	CH-13156	AI-3358	CH-12278	699435	ST-13527
1499704	CH-12660	8005628	CH-12839	AI-3207	CH-13157	AI-3359	ST-13528	760884	ST-13531
1499708	CH-12238	8005814	ST-13531	AI-3208	CH-12208	AI-3361	ST-16487	PEL-JOB	
1499709	CH-16873	8006605	CH-12385	AI-3214	CH-12260	AI-3363	ST-16488	E6050036	CH05-11106
1499714	CH-12278	8406317	CH-12386	AI-3215	CH-13150	AI-3369	CH-12604	E7410157	CH04-11675
1499724	CH-12236	917275	ST-16487	AI-3220	CH-12216	AI-3370	CH-12605	E7415256	CH05-14409
1499730	CH-12232	917276	CH-12231	AI-3221	CH12-11389	AI-3373	CH-11789	PENNZOIL	
1499743	CH08-12221	933360	CH-12231	AI-3225	CH-12262	AI3381	CH-11211	PZA-117	PF-15684
1499747	CH-12285	966360	CH-12231	AI-3233	CH-13141	AI-3394	CH-12387	PZA-123	PF-15683
1499752	CH06-11056	OSHKOSH		AI-3236	CH-12264	AI-3410-08	CH06-11941	PERKINS	
1499756	CH-12091	1D-14	CH-12260	AI-3237	CH-12980	AI-3446-08	CH-14211	197946201	CH-16873
178637	CH14-12245	1DX-31	CH12-12251	AI-3238	CH-12249	AI-3679	CH-14387	24811/2	ST09-12265
178638	SC14-12254	1DX-88	CH16-12253	AI-3239	CH14-12245	AI-5010	PF-15684	26510143	CH05-11106
202550	SC10-11317	8400	CH-12262	AI-3240	SC14-12254	AI-5031	PF-15686	26510154	CH12-11389
202551	CH10-11308	9977-G	CH-12260	AI-3242	CH-12209	AI-5109	PF-15690	26510192	CH05-11106
2271979	CH08-14410	OTIS MATL HANDLING		AI-3246	CH08-12243	AI5169	PF-15693	26510208	CH10-11308
2271980	ST08-14413	13943951	CH05-11106	AI-3247-08	CH12-12251	AL-3359	ST-13528	26510211	CH08-11003
2292386	SC10-12395	14279911	CH08-12243	AI-3254	CH-12204	AL-3361	ST-16487	26510214	CH08-11288
2292387	CH10-12390	9033-AX1	CH08-12243	AI-3270-08	CH-12275	AL-3363	ST-16488	26510228	ST08-11316
2292387	CH10-14455	9033-AY1	CH05-11106	AI-3273	CH08-11288	P.M.C.		26510229	CH08-11288
243153	CH05-11106	A-50991	CH04-11675	AI-3274-08	CH06-11295	PE-6169	CH-12215	26510230	SC12-11391
440337	CH14-12245	OWATONNA		AI-3276-08	CH10-11308	PACCAR		26510231	CH06-11295
490238	CH06-11295	420-1815	CH05-11106	AI-3277	SC10-11317	Y 057 534 12	CH12-11389	26510235	CH09-12244
490328	CH06-11295	42018158	CH05-11106	AI-3279	CH05-11106	Y 057 535 10	CH14-12245	26510236	CH-12209
524658	CH04-11675	420-18567	CH05-11106	AI-3279-08	CH05-11106	Y 057 542 09	CH16-12253	26510238	CH14-12245
524685	CH12-12251	420-1923	CH05-11106	AI-3280	CH-12250	PACIFIC CAR & FOUND		26510288	ST08-11316
576975	ST06-11315	42019238	CH05-11106	AI-3280	CH-16874	461470	CH-12262	26510289	CH14-12245
576977	ST06-11315	420-2127	CH05-11106	AI-3282	CH-12826	462252	CH-12260	26510306	CH10-12390
583135	CH09-12244	420-31932	CH04-11675	AI-3284	CH-12386	PANHARD		26510306	CH10-14455
583136	ST09-12265	P & H HARNISCHFEGE		AI-3297-08	CH08-12221	431455	CH08-11935	26510313	SC10-12395
583226	CH-12980	1046Z283	CH12-11389	AI-3298	ST08-11316	PATAPSCO & BACK RI		26510337	CH07-14074
589562	CH12-12251	1046Z329	CH14-12245	AI-3301	CH-12242	0607B0102	CH05-11106	26510338	ST07-14270
599753	CH-12269	1046Z335	CH10-11308	AI-3302	CH-12385	PEERLESS		26510342	CH08-17365
599756	CH-12269	1046Z378	CH09-12244	AI-3303	CH-12235	300-5-214-02	CH12-11389	26510343	ST08-14413
599757	SC-12270	221046Z38	CH14-12245	AI-3307	CH-12231	PEGASO		26510353	CH-16928
718023	CH12-11389	221046Z39	SC14-12254	AI-3309-08	CH06-11056	173260	CH-14107	26510354	CH-16928
718024	SC12-11391	221046Z48	CH14-12245	AI-3315	CH-12276	190537	CH-12385	26510362	CH05-14409
718057	ST08-11316	221046Z5	CH-12385	AI-3316	CH-12225	197.588	CH-12278	6LS551A/4	CH-12235
718058	CH08-11288	221046Z6	CH-12242	AI-3320	CH-12247	197.589	ST-13528	CV 20948	CH-16689
718059	ST08-11316	46Z166	CH12-12251	AI-3328	CH-16873	534478	CH-12386	P102913	ST08-11316
718325	CH-12266	P.A.I.		AI-3332	ST-13531	584576	CH-12235	PF-60011	CH05-11106
744821	CH-12386	FAF-4563	CH-12268	AI-3333	ST-13527	632114	CH-12242	PF60053	CH12-12251
762792	CH-12225	P.B.R.		AI-3336-08	CH09-12244	634478	CH-12386	PF60999	ST-14183
765568	CH-12397	AC-3284	CH-12386	AI-3338	CH-12266	634479	CH-12231	PI02619	ST10-11239
765821	ST-13530	AI-3003	PF-15677	AI-3346	CH-12232	645372	CH-12385	PI02620	ST12-11390
773604	ST-13531	AI-3012	CH-12215	AI-3350	ST09-12265	691.030	CH09-12244	PI02673	ST06-11315

Cross Reference by Manufacturer



MFRS. NO.	OUR NO.	MFRS. NO.	OUR NO.	MFRS. NO.	OUR NO.	MFRS. NO.	OUR NO.	MFRS. NO.	OUR NO.
PI02679	CH08-11288	FA3151	CH-12209	PAK-939	CH06-11056	040.741	CH-12385	Q02505-99	CH09-12244
PI02688	ST08-11316	FA3153	CH-11211	PAK-988	CH08-11288	040.907	CH-12888	S08505-10	CH08-11288
PI026880	ST08-11316	FA3162	CH-12283	PAK-992	CH10-11308	041.327	CH05-11106	T19505-55	CH08-11935
PI02689	ST09-12265	FA3192	ST08-11316	PETTIBONE-MULLIKEN		041.430	CH-12235	T1950555	CH08-11935
PI02707	SC10-11317	FA3193	ST06-11315	2813-P	CH08-12243	041.500	CH-12278	U04505-43	CH-12276
PI02871	CH05-11555	FA3291	CH-12232	A-23180-14	CH08-12243	POCLAIN		V02505-50	ST08-11316
PI02876	CH10-11117	FA3301	CH-12980	A-23180-18	CH12-12251	10505-06	SC21-17075	V02505-81	ST08-11316
PI02912	ST08-11110	FA3320	CH-12213	A-23180-23	CH08-12243	10505-07	CH21-17070	V04504-43	CH-12276
PI02913	ST08-11316	FA3321	CH-16873	A-23180-35	CH-12262	1505-49	CH12-12251	W0350586	CH-12235
PI02914	ST05-11108	FA3322	CH-12250	CM-921	CH08-12243	2505-66	ST06-11315	W04505-44	SC10-11317
PI02916	ST05-11618	FA3322	CH-16874	CM-94	CH05-11106	2505-67	CH06-11295	W27-505-44	ST-13527
PI02917	CH08-11935	FA3431	CH-12236	EMP-67	CH05-11106	2505-90	CH-12231	X08505-38	CH-12266
PI02924	SC12-11391	FA3839	CH-12826	LL-5448	CH-12260	2505-91	CH-12385	X08505-61	SC12-11391
PI02927	CH06-11056	FA4000	CH-11789	LL-847-144	CH14-12245	4505-43	CH-12276	Z08505-62	CH12-11389
PI02928	ST-12226	FA4101	PF-15690	LL-847-43	CH12-12251	8505-01	ST09-12265	POWER BOSS	
PI02929	ST06-12048	FA4102	PF-15693	PIPERCROSS		8505-61	CH12-11389	302597	ST05-14980
PI02930	CH06-11880	PERRY		PX 102	CH12-11389	8505-62	SC12-11391	302842	CH05-11106
PI02931	CH07-14074	PA-302	PF-14090	PX 1030	CH08-12228	8505-68	CH-12273	POWERFLO	
PI02932	ST07-14270	PA-302	PFM-14095	PX 104	CH06-11038	8505-69	SC-12274	AFL-3192	PF-15683
TX56178	CH09-12244	PA-474	CH08-12243	PX 105	CH05-11106	A08505-28	CH16-12253	FCL-1697	PF-15684
PERLINI		PA-480	CH05-11106	PX 1052	ST-16488	C11505-31	CH05-11106	POWERPART	
01000965	SC14-12254	PA-497	CH-12210	PX 1053	ST-16487	E02505-67	CH06-11295	AM044901	CH12-12251
01000967	CH14-12245	PA-498	CH-13150	PX 106	CH-12242	E025505-66	ST06-11315	AM044902	PF-15680
0110281/11	CH-12266	PA-499	CH-12214	PX 108	CH-12246	E08505-68	CH-12273	AM044905	CH-12206
102264P	CH-12266	PA-589	CH-12403	PX 109	CH14-12245	E10505-06	SC21-17075	AM044906	CH-12839
350044AA	CH-12278	PA-597	CH-12207	PX 110	CH-12385	E12505-60	CH-12214	PPM	
350087A	CH-15673	PA-598	CH-13157	PX 111	CH10-12224	E2750574	ST-13529	C.6150593	CH-16294
350088A	SC-15681	PA-599	CH-12208	PX 112	CH12-12251	F02505-66	ST06-11315	D.6150594	SC-16301
66002073	CH12-12251	PA-600	CH-13156	PX 115	CH08-11288	F02505-90	CH-12231	L2650576	CH10-12390
PERMATIC		PA-695	CH-12209	PX 118	CH-12826	F025505-67	CH06-11295	L2650576	CH10-14455
FA 3126	CH06-11038	PA-706	CH-12275	PX 120	CH-12213	F08505-45	ST-13531	W 04505-43	CH-12276
FA1371	CH-12500	PA-789	CH-14104	PX 122	CH-12289	F08505-68	CH-12273	PRINS MOTOREN	
FA1372	CH-12279	PA-834	CH-12268	PX 123	CH-12235	F10505-07	CH21-17070	P10.11420.1118.	PF-15703
FA1433	CH-13889	PA-835	CH14-12245	PX 124	CH-11211	F12505-61	CH-13156	P10.15401.1108.	CH05-11106
FA1456	CH-13190	PA-836	CH12-11389	PX 127	CH-12214	G02505-91	CH-12385	P10.15606.1108.	CH06-11038
FA1462	CH-13939	PA-929	CH-12209	PX 128	CH-12264	G08505-46	ST-16487	P10.15741.1108.	CH-12716
FA1566	CH-15304	PA-972	CH-12273	PX 134	CH-16873	G08505-69	SC-12274	PURFLUX	
FA1569	CH-15294	PA-975	CH05-12222	PX 140	CH-12273	H08505-01	ST09-12265	A209	CH-12236
FA3107	CH-14107	PAK-480	CH05-11106	PX 142	CH-12283	H10105-78	SC10-11317	A287	CH-15300
FA3113	CH-12809	PAK-530	CH-12262	PX 144	CH10-11308	H10505-78	SC10-11317	A473	CH-13939
FA3116	CH-12093	PAK-532	CH-12262	PX 149	CH-12248	K17505-62	CH-12278	A517	PF-15684
FA3121	CH-13763	PAK-568	CH-12260	PX 158	CH-12752	L03505-30	CH-12385	A537	CH12-12251
FA3123	CH-12277	PAK-591	CH12-12251	PX 175	CH-12234	L08505-50	SC-12270	A540	CH05-11106
FA3127	CH05-11106	PAK-703	CH08-12221	PX 859	CH-12980	M08505-29	SC-12252	A542	CH14-12245
FA3131	CH06-11295	PAK-705	CH08-11288	PX 938	CH14-12245	M08505-51	CH-12269	A543	CH12-11389
FA3132	CH-12825	PAK-706	CH-12275	PNEUMOFORE		M21505-34	CH-12798	A544	CH16-12253
FA3141	CH-12491	PAK-826	ST-12226	040.428	CH-12985	N08505-29	SC-12252	A545	CH06-11295
FA3147	CH-13520	PAK-827	CH05-11467	040.436	CH-12397	P20505-09	CH-12214	A546	CH08-11288
FA3150	CH-12485	PAK-925	CH14-13356	040.659	CH-12231	Q01505-49	CH12-12251	A550	SC14-12254

Cross Reference by Manufacturer



MFRS. NO.	OUR NO.	MFRS. NO.	OUR NO.	MFRS. NO.	OUR NO.	MFRS. NO.	OUR NO.	MFRS. NO.	OUR NO.
A551	SC12-11391	A914	CH04-11675	A52220	CH12-11389	AF-14	PF-15677	AF-3028	CH09-12244
A552	ST08-11316	A916	CH-13150	A52266	SC12-11391	AF-17064	CH-12262	AF-3029	ST09-12265
A596	CH-12282	A920	CH-13141	A52928	CH-13141	AF-2011	CH04-11675	AF-3031	ST06-11315
A597	CH-12246	A922	CH-12208	A53152	CH06-11056	AF-2011K	CH04-11675	AF-3098	ST-16488
A598	CH-12386	A923	CH-12214	A53175	CH-12271	AF-2019	CH05-11106	AF-3100	ST-13530
A599	CH-12385	A948	CH-12234	A53511	ST08-11110	AF-2019K	CH05-11106	AF-3101	ST-13531
A600	CH-12242	A949	CH10-11308	A53516	ST-13410	AF-2029	CH-12209	AF-3102	ST-13527
A602	CH-12235	A956	CH-12809	A58047	CH-12208	AF-2039K	CH08-12221	AF-3103	ST-13529
A784	CH-12177	A969	CH-15304	A61568	CH-12242	AF-2040	CH08-12243	AF-3104	ST-13528
A786	CH-12660	A970	CH-12507	A61605	CH-12386	AF-2044K	CH08-11288	AF-3112	CH-12213
A787	CH-12209	A971	CH-15294	A62044	CH08-11288	AF-2051	CH-12275	AF-3116	CH-12225
A791	CH-12250	PURULATOR		A62055	CH-13150	AF-2051K	CH-12275	AF-3152	CH06-11056
A791	CH-16874	6675974	CH12-12251	A62125	CH-12260	AF-2052	CH-13157	AF-3156	ST-14343
A793	CH-16873	6678200	CH12-11389	A62200	SC14-12254	AF-2053	CH-13156	AF-3157	SC10-11317
A795	CH-12980	6678201	CH14-12245	A62202	CH-12269	AF-2055	CH-13150	AF-3162	CH14-13356
A797	CH-12238	6696758	CH21-17070	A62204	CH10-11308	AF-2073K	CH12-12251	AF-3163	SC14-13357
A799	CH-12248	6711326	CH-12271	A62206	SC-12274	AF-2102	CH-12249	AF-3175	CH-12271
A800	CH-12826	6711329	CH-12272	A62221	CH14-12245	AF-2110	CH-12260	AF-3176	CH-12272
A801	CH-12231	7308924	CH-12262	A62222	CH-12273	AF-2110K	CH-12260	AF-3192	PF-15683
A802	CH-11211	9304811	CH-12214	A62973	CH05-11467	AF-2114	CH-12212	AF-3253	CH-12282
A803	CH-12213	A11042	CH-12953	A62974	CH06-14733	AF-2125	CH-12260	AF-3310	CH-12206
A804	CH-12289	A12102	CH-12249	A63028	CH09-12244	AF-2140	CH14-12245	AF-3314	SC10-12395
A806	CH-12247	A13192	PF-15683	A63029	ST09-12265	AF-2199	SC-12270	AF-3332	CH-12209
A807	CH-12091	A13310	CH-12206	A63031	ST06-11315	AF-2200	SC14-12254	AF-3346	CH-12177
A808	CH-12264	A13346	CH-12177	A63101	ST-13531	AF-2202	CH-12269	AF-3393	CH08-11288
A809	CH-12232	A22011	CH04-11675	A63102	ST-13527	AF-2204K	CH10-11308	AF-3425	CH-12809
A813	CH-12278	A23465	PF-15684	A63157	SC10-11317	AF-2206	SC-12274	AF-3427	CH-11211
A814	ST-13530	A27050	PF-15693	A63314	SC10-12395	AF-2220	CH12-11389	AF-3438	PF-14090
A815	ST-13531	A27758	CH-12397	A63393	CH08-11288	AF-2220H	CH12-11389	AF-3438	PFM-14095
A821	CH-12225	A30890	CH-12262	A63438	PF-14090	AF-2221	CH14-12245	AF-3459	ST08-11316
A865	CH-12249	A32238	CH05-12222	A63438	PFM-14095	AF-2222	CH-12273	AF-3465	PF-15684
A866	CH-12397	A34536	CH-12091	A63459	ST08-11316	AF-2238K	CH05-12222	AF-3492	CH-12283
A866PL	CH-12397	A40015	PF-14090	A63519	CH-12385	AF-2255	CH-14104	AF-3498	CH-12235
A869	SC-12274	A40015	PFM-14095	A64428	CH-12867	AF-2256	SC10-11317	AF-3502	SC18-17232
A871	CH-12283	A42019	CH05-11106	A64551	CH-12225	AF-2266	SC12-11391	AF-3511	ST08-11110
A873	ST06-11315	A42029	CH-12209	A64559	CH-12276	AF-2266H	SC12-11391	AF-3516	ST-13410
A875	SC10-11317	A42039	CH08-12221	A64560	SC10-11317	AF-2269	CH14-12245	AF-3519	CH-12385
A876	CH-12276	A42051	CH-12275	A69334	CH-12214	AF-2896	ST-12226	AF-3536	CH18-17230
A877	ST-13527	A42073	CH12-12251	A70014	PF-15677	AF-2897	CH-12268	AF-3537	CH-12285
A878	CH09-12244	A42114	CH-12212	A72897	CH-12268	AF-2908	ST06-11315	AF-3549	CH-12264
A879	CH-12285	A42896	ST-12226	A72921	SC21-17075	AF-2909	CH06-11295	AF-4428	CH-12867
A880	ST-16487	A43156	ST-14343	A72922	CH21-17070	AF-2915	CH05-11106	AF-4536	CH-12091
A883	CH06-11056	A43176	CH-12272	A73162	CH14-13356	AF-2918	CH-13141	AF-4548	CH-12403
A884	ST-12226	A43332	CH-12209	A73163	SC14-13357	AF-2921	SC21-17075	AF-4551	CH-12225
A886	CH-12387	A44548	CH-12403	A73498	CH-12235	AF-2922	CH21-17070	AF-4559	CH-12276
A890	ST-13529	A49378	CH-12207	A73502	SC18-17232	AF-2928	CH-13141	AF-4560	SC10-11317
A891	CH-12271	A52052	CH-13157	A73536	CH18-17230	AF-2952	SC14-13357	AF-8047	CH-12208
A892	CH-12272	A52053	CH-13156	AF-10-0890	CH-12262	AF-2973	CH05-11467	AF-9045	CH-12210
A906	CH-13889	A52199	SC-12270	AF-10-089084	CH-12262	AF-2974	CH06-14733	AF-9334	CH-12214

Cross Reference by Manufacturer



MFRS. NO.	OUR NO.	MFRS. NO.	OUR NO.	MFRS. NO.	OUR NO.	MFRS. NO.	OUR NO.	MFRS. NO.	OUR NO.
AF-9378	CH-12207	PM-1714	CH-12247	QSA-3307	CH-12847	77 01 025 065	ST-16488	50 10 094 094	CH-15304
AFP-15	PF-14090	PM-1715	CH-12236	QSA-3441	PF-15684	RENAULT V.I.		50 10 094 144	CH-12242
AFP-15	PFM-14095	PM-175	CH-12235	QSA-3559	PF-15683	0002241034	CH-12232	50 10 094 145	CH-12507
AM-1139	ST06-11315	PM-1750	CH-12235	QSA-507	CH14-12245	0003563021	CH-12278	50 10 094 146	CH-15294
FCA-1697	PF-15684	PM-1758	CH-12397	QSA-507-SY	SC14-12254	0003563592	CH-12980	50 10 140 505	CH-12386
LI-2695	CH-11348	PM-1760	CH-12278	QSA-523	CH12-11389	0003564138	SC14-12254	5000 819 025	CH10-12224
LI-3868	CH-12249	PM-1761	CH-12238	QSA-523-SY	SC12-11391	0004214489	CH-12242	5000241756	CH-12385
LI-4112	CH-12216	PM-1762	CH-12231	QSA-535	CH-12273	0004309015	CH-12386	5000241796	CH-12385
LI-4113	CH-12215	PM-2080	CH08-11288	QSA-535-SY	SC-12274	0022004800	CH-12242	5000242503	CH-12242
LX-84	CH-11211	QIF-AIR		QSA-546-SY	SC10-11317	0022860400	CH-12235	5000242504	CH-12235
MF-190	CH-12206	ACA-224	CH-12208	QSA-563	CH-12269	0024551184	CH-12385	5000751590	CH-12507
MF-192A	CH-12177	ACA-226	CH-12214	QSA-563-SY	SC-12270	0024551192	CH-12268	5000751674	CH-15294
MF-500A	CH-12177	ACA-226-SY	CH-13141	QSA-586	CH-14104	003563512	CH-12385	5000783932	CH-12242
MF-651A	CH-12209	ACA-233	CH-12210	QSA-597	CH-12268	003563513	CH-12235	5000802977	ST-13531
MF-700A	CH12-11389	ACA-234	CH-13150	QSAK-1531	CH05-11467	003563565	CH-12386	5000802978	ST-13527
MF-706A	CH-12660	ACA-236	CH-13156	QSAK-1544	CH08-11288	003563570	CH-12231	5000806317	CH-12278
MF-712A	CH-12213	ACA-237	CH-13157	QSAK-1563	CH05-11106	003563595	CH-12242	5000806377	CH-12278
MF-713A	CH-12653	ACA-252	CH-12262	QSAK-255	CH12-12251	003563608	CH-12235	5000807395	CH-13050
MF-839A	CH-12235	ACA-507-SY	SC14-12254	QSAK-256	CH05-11106	003563616	CH-12397	5000814797	CH-15565
MF-860K	CH08-11288	ACA-508	CH-12275	QSAK-508	CH-12275	003564000	CH-12262	5000814798	SC-15604
MFP-191A	CH-12839	ACA-510	CH08-12221	QSAK-510	CH08-12221	003564001	CH12-12251	5000814947	CH-13190
MFP-192A	CH-12177	ACA-523-SY	SC12-11391	QSAK-530	CH04-11675	003564024	CH05-11106	5000814950	CH-13939
MFP-764A	CH-12249	ACA-546	CH10-11308	QSAK-546	CH10-11308	003564087	CH-12260	5000814957	CH-13889
PEA-526	CH-12653	AP-11-7433	CH-12269	QSAK-553	CH05-12222	003564105	CH08-11288	5000819339	CH12-11389
PEA-537	CH-12215	AP-11-7435	CH-12273	QSAK-565	CH08-11288	003564106	ST08-11316	5000819340	CH14-12245
PEA-549	CH-12216	AP-11-7437	CH14-12245	RAYGO		003564115	SC12-11391	5000819341	CH12-12251
PEA-559	SC12-11391	AP-11-7439	CH12-11389	13400-13	CH05-11106	003564117	CH12-11389	5000819342	CH-12282
PEA-562	CH-12249	AP-11-7782	CH21-17070	134200-20	CH05-11106	003564118	CH14-12245	5001 829 572	CH-12235
PM-1042	CH-12953	AP-11-7797	CH-12268	134200-52	CH08-12243	003564119	SC14-12254	5001 834 600	CH-15300
PM-1058	CH-12209	AP-11-9363	CH08-11288	134200-89	CH10-12224	003564120	CH14-12245	5001836978	CH-15294
PM-1073	CH-12091	AP-12-8407	CH18-17230	205242	CH-12262	003564125	CH10-11308	500241796	CH-12385
PM-1087	CH-12216	QUAKER STATE		205713	CH-12262	003564126	SC10-11317	500242503	CH-12242
PM-1088	CH-12215	QSA-1543-SY	ST06-11315	205747	CH12-12251	003564127	SC10-11317	5010 230 841	CH-16523
PM-1102	SC12-11391	QSA-1544-SY	ST08-11316	216917	SC-12270	003564128	CH-12266	5010 305 203	CH-15304
PM-1123	ST08-11316	QSA-1569	CH14-13356	216921	CH-12269	003564135	CH-12282	5010094092	CH-15294
PM-1139	ST06-11315	QSA-1569-SY	SC14-13357	221688-A	CH05-11467	003564137	CH16-12253	5010094154	CH-15304
PM-1141	ST08-11316	QSA-1581	CH-12268	670000-24	CH14-12245	004207090	CH-12386	7701019017	CH-12386
PM-1151	CH-12250	QSA-216	CH-12207	670000-37	CH05-11106	004212747	CH-12385	7701019018	ST-13530
PM-1151	CH-16874	QSA-224	CH-12208	670000-42	CH10-12224	004212748	CH-12242	7701021498	ST-13531
PM-1568	CH-12242	QSA-226	CH-12214	670000-43	CH14-12245	004214189	CH-12242	7701027436	CH-12500
PM-1574	CH-12248	QSA-226-SY	CH-13141	670000-44	CH-12266	004214313	CH-12385	7701027437	CH-12279
PM-1588	CH-12660	QSA-229	CH-12209	READY-POWER		004214314	CH-12242	REXNORD	
PM-1605	CH-12386	QSA-233	CH-12210	5500416	CH08-12243	0060377200	CH-12385	1021006610	CH16-12253
PM-1621	CH-12234	QSA-234	CH-13150	5500560	SC12-11391	24551160	CH-12386	1021006611	SC-12252
PM-1623	CH-16873	QSA-236	CH-13156	5500611	CH05-11106	4033109540	CH-12980	10281780	CH08-12243
PM-1627	CH-12980	QSA-237	CH-13157	602450	CH05-11106	50 10 064 371	CH-15304	102817801	CH08-12243
PM-1628	CH-12232	QSA-244	CH-12260	602450-1	CH05-11106	50 10 064 372	CH-12507	REYTOR	
PM-1707	CH-12246	QSA-252	CH-12262	RQ-34083	CH05-11106	50 10 066 304	CH-15300	IT100853	CH06-14733
PM-1709	CH-12385	QSA-265	CH-12262	RENAULT AGRICULTU		50 10 066 387	SC-12252	IT101222	CH06-11038

Cross Reference by Manufacturer



MFRS. NO.	OUR NO.	MFRS. NO.	OUR NO.	MFRS. NO.	OUR NO.	MFRS. NO.	OUR NO.	MFRS. NO.	OUR NO.
IT101234	CH10-12224	CV4180	CH12-11389	HDA5111	CH-13150	HDA5335	CH-12273	100505-21E	CH-13074
IT101246	CH08-11003	CV507	CH-15300	HDA5114	CH-12271	HDA5336	CH-12266	100505-30L	CH08-11942
IT101275	CH05-11106	CV-9685	CH-15300	HDA5119	CH10-11308	HDA5338	CH-12269	24999	ST06-11109
IT102090	CH-12260	OE30128	CH-12262	HDA5120	CH10-12224	HDA5339	SC-12270	393199	CH-12386
IT106587	CH12-11389	OE45176	CH10-11308	HDA5121	CH-12207	HDA5357	SC10-12395	51021000	CH04-11675
IT106641	SC-12252	UE5801	CH-12177	HDA5132	CH12-12251	HDA5364	ST06-11315	53953.6	ST06-11315
IT106769	CH14-12245	UE9813	CH-12177	HDA5133	CH-12208	HDA5367	CH08-12221	54012007	CH-12209
IT106775	SC14-12254	ROMA		HDA5157	CH-12214	HDA5395	SC21-17075	55010001	CH06-11941
IT106834	SC12-11391	R-1050	CH-12278	HDA5159	CH-12210	HDA5396	CH21-17070	61807.4	ST06-12048
IT108674	SC10-11317	R-1070	CH-12249	HDA5162	CH-12397	HDA5397	CH-12268	63496.4	CH07-14865
IT109085	SC-12274	R-1096-S	SC10-11317	HDA5165	CH-12249	HDA5402	CH14-13356	63497.2	ST07-14270
IT109086	CH-12273	R-1185	CH-12264	HDA5183	CH-12231	HDA5403	SC14-13357	66448.2	CH08-17365
IT109155	CH-12266	R-3005	SC12-11391	HDA5184	CH-12209	HDA5409	CH06-11295	66449.0	ST08-14413
IT109200	CH-12269	R-517	CH-12235	HDA5192	CH-12225	HDA5414	ST08-11316	SAME	
IT109206	SC-12270	R-517S	ST-13529	HDA5193	CH-12091	HDA5415	CH06-14733	2.4249.010.1	CH04-11675
IT1113	CH-12214	R-5386	CH-12283	HDA5194	CH-12980	HDA5417	CH10-11308	2.4249.010.6	CH04-11675
IT1116	CH-12210	R-637	CH14-12245	HDA5199	CH-12232	HDA5418	CH06-11056	2.4249.040.1	CH06-11295
IT114500	ST06-11315	R-637-S	SC14-12254	HDA5202	CH-12248	HDA5419	ST-12226	2.4249.050.1	CH05-12222
IT117781	SC21-17075	R-641	CH-12209	HDA5206	CH-16873	HDA5420	ST09-12265	2.4249.050.4	ST-12226
IT117782	CH21-17070	R-6460	CH-12980	HDA5207	CH-12235	HDA5422	CH09-12244	2.4249.060.1	CH06-11295
IT118211	CH14-13356	R-650	CH-16873	HDA5210	CH14-12245	HDA5426	CH05-11467	2.4249.060.8	CH06-11295
IT118216	SC14-13357	R-797	CH-12386	HDA5212	CH-11211	HDA5427	ST-13410	2.4249.070.2	ST06-11315
IT120022	CH09-12244	R-804	CH-12231	HDA5213	CH-12246	HDA5442	CH05-11106	2.4249.070.4	ST06-11315
IT128407	CH18-17230	R-8047	CH-12208	HDA5214	CH-12264	HDA5447	ST-14343	2.4249.080.1	CH06-11056
IT128408	SC18-17232	R-8047-S	CH-13157	HDA5216	CH-12247	HDA5450	PF-14090	2.4249.080.2	ST-12226
IT510	CH-12209	R-9045	CH-12210	HDA5226	CH-12212	HDA5450	PFM-14095	2.4249.090.1	CH-12220
IT712	CH-13157	R-918	CH05-11106	HDA5232	CH-12867	HDA5459	CH08-12228	2.4249.110.1	CH08-12221
IT713	CH-13156	R-930-S	ST-16488	HDA5246	CH-13141	HDA5465	SC10-11317	2.4249.110.2	CH08-12221
IT912	CH-12208	R-940-S	ST-13531	HDA5265	CH-12215	HDA5488	CH-12276	2.4249.130.0	CH08-11288
IT9972	CH-13141	R-941	CH-12232	HDA5266	CH-12216	HDA5490	CH08-12228	2.4249.130.1	CH08-11288
RICHIER		R-9601-S	ST-13527	HDA5272	CH-12283	HDA5493	CH18-17230	2.4249.130.2	ST08-11316
556012165	CH09-12244	RYCO		HDA5276	CH-12262	HDA5494	SC18-17232	2.4249.130.7	ST08-11316
556012179	ST06-11315	A-137	CH-12212	HDA5280	CH10-12224	HDA5504	CH-12286	2.4249.130.8	CH08-11288
556012181	CH08-11288	A-138	CH-12249	HDA5281	CH12-12251	HDA5507	ST08-11110	2.4249.130.9	ST08-11316
556012182	CH08-11288	A-20	CH-12209	HDA5285	CH08-11003	HDA5526	ST-13530	2.4249.131.0	CH08-11935
556012183	ST08-11316	A-201	CH-12177	HDA5286	CH05-11106	HDA5527	ST-13531	2.4249.170.6	CH06-11056
556012184	CH06-11295	A-209	CH-12091	HDA5288	CH-12260	HDA5528	ST-13527	2.4249.190.1	CH05-12222
556012185	CH09-12244	A-236	CH-12209	HDA5292	CH04-11675	HDA5588	CH-12285	2.4249.250.1	CH-12205
556012186	ST09-12265	A-26	CH-11348	HDA5305	CH08-12221	HDA5623	CH-12225	2.4249.280.1	SC10-11317
556012187	CH08-11288	A-264	CH-12091	HDA5306	CH-12275	HDA5664	CH06-11295	2.4249.280.3	CH-12276
556012189	CH08-11288	A-308	CH-12215	HDA5308	CH08-11288	HDA5666	CH06-11038	2.4249.290.1	CH08-12228
556012190	ST08-11316	A-35	CH-12206	HDA5317	CH12-11389	HDA5711	CH-12238	2.4249.310.4	CH08-11935
556012193	CH12-12251	A-48	CH-12839	HDA5321	CH14-12245	HDA5741	CH-12847	2.4249.340.1	CH-12290
556012197	CH05-11106	HDA5050	CH04-11675	HDA5322	SC14-12254	HDA5757	CH-12278	2.4249.340.2	ST-14113
556012198	SC10-11317	HDA5055	CH-12272	HDA5323	SC12-11391	HDA5760	CH-12270	2.4249.360.1	CH12-11389
556012199	CH10-11308	HDA5061	CH05-11106	HDA5327	CH10-11308	SAKAI		2.4249.380.1	CH-12798
597033071	CH09-12244	HDA5081	CH-12209	HDA5328	SC10-11317	440414002	SC10-11317	2.4249.380.2	SC10-12395
ROLLS ROYCE		HDA5109	CH-13157	HDA5330	CH05-12222	440414003	CH10-11308	2.4249.500.1	CH06-11056
CV4170	CH14-12245	HDA5110	CH-13156	HDA5334	SC-12274	SAMBRON		2.4249.500.2	ST-12226

Cross Reference by Manufacturer



MFRS. NO.	OUR NO.	MFRS. NO.	OUR NO.	MFRS. NO.	OUR NO.	MFRS. NO.	OUR NO.	MFRS. NO.	OUR NO.
242292001	CH-13074	9.23.169.17	CH-12839	E70211804	ST09-12265	30-8047	CH-12262	1252-01	ST12-11390
SAMSUNG		9.23.211.17	CH-12249	E70211902	SC14-12254	46-0961	CH-12262	1252-02	SC12-11391
991240800	SC10-12395	9.23.236.17	CH-12213	E70211905	CH14-12245	46-1253	CH12-12251	1254.02.00	SC14-12254
9912-45700	CH12-11389	9.23.237.17	CH-12660	E70212061	CH06-11295	46-1470	CH-12262	1256-02	SC-12252
9912-45800	SC12-11391	9.23.243.17	CH-12091	SCANIA		46-2252	CH-12260	1257.35.00	ST06-12048
SANDERSON		9.23.244.17	PF-15677	1335678	CH-14902	SIFO		1261-01	CH-12091
ABP3001562	CH-12209	9.23.245.17	PF-15680	1335679	CH-14896	120501-3	CH04-11675	1262-01	CH-12285
ABP3001567	CH-12867	9.23.322.17	PF-15684	1387548	CH-16922	130022	CH05-11106	1265-97	CH06-12258
ABP3001571	ST08-11110	9.23.332.17	ST08-11316	1421021	CH-14902	192003	CH04-11675	1267.05.00	CH06-11941
SAURER		9.23.362.17	CH10-11308	1421022	CH-14896	SISU		1267.06.00	CH-13270
4631072	CH-12385	9.23.363.17	CH08-11288	211589	CH-16873	126-340-0241	CH-16873	1267-01	CH-13270
4631072000	CH-12242	9.23.404.17	CH-12235	217517	CH-12235	129-340-0332	CH18-17230	1267-05	CH06-11941
4631072010	CH-16873	9.23.416.17	CH-12278	218989	CH-12385	129-340-0342	SC18-17232	1267-06	CH-13270
4631072020	CH-12242	9.23.420.17	CH-12385	219517	CH-12235	1293400401	CH-15300	1268.09.00	CH08-11935
SAVARA		9.23.446.00	CH-12242	2195196470	CH-12235	SOFILTRA		1268-6807	CH08-14703
9.20.267.17	CH-12215	9.23.446.17	CH-12242	235586	CH-12242	1235-01	CH05-11106	1270-01	CH-12262
9.20.282.17	CH-13157	9.23.467.17	CH-12386	261185	CH-12264	1235-02	CH05-12222	1270-02	CH10-11308
9.20.401.17	CH-12208	9.23.471.17	CH-12238	309441	CH-12264	1235-11	CH05-11106	1270-11	CH10-12224
9.22.137.17	CH-11348	9.23.474.17	CH-12247	310813	CH14-12245	1236.66.43	CH06-11880	1270-12	CH12-12251
9.22.266.17	CH-12215	9.23.475.17	CH-12246	310814	SC14-12254	1236-0700	CH-13824	1270-13	CH12-11389
9.22.267.17	CH-12216	9.23.517.17	CH-12264	310816	CH16-12253	1236-11	CH06-11038	1270-14	CH-12268
9.22.861.17	CH-12177	9.23.518	ST-13529	310817	SC-12252	1236-15	CH06-11295	1270-22	CH10-11308
9.22.863.17	CH-12206	9.23.518.17	ST-13529	365729	CH-12264	1236-22	CH06-11295	1272-02	CH12-11389
9.22.897.17	SC10-11317	9.23.524.17	CH-12282	368016	ST-13529	1237-0107	CH07-14865	1272-03	CH-12262
9.22.901.17	CH-12214	9.23.539	CH12-11343	370754	CH-12264	1238.27	CH-13818	1272-22	CH12-11389
9.22.903.17	SC14-12254	9.23.539	CH-13477	395773	CH-12387	1238.27.07	CH-13818	1273-55	CH-12268
9.22.906.17	CH14-12245	9.23.676.17	CH-12231	SCHAEFF		1238-02	CH08-12221	1274.22.00	CH14-12245
9.22.941.17	CH-12262	9.23.677	ST-13527	55.27655810	CH05-11106	1238-0700	CH-13811	1276-22	CH16-12253
9.22.944.17	CH05-11106	9.23.711.17	CH-12278	5501642717	CH-12225	1238-11	CH08-11003	SOFIMA	
9.22.946.17	CH04-11675	9.23.843.17	CH-13763	5501642727	ST-16876	1238-16	CH08-11288	7178A	CH-13763
9.22.950.17	CH12-11389	9.27.026.17	CH-12208	SCHLUTER		1238-17	CH08-11288	S7356A	CH08-14410
9.22.951.17	SC12-11391	SA-919	CH-14387	S-AJ502	CH-12385	1238-23	CH08-11288	SOPARIS	
9.23.002.17	PF-14090	SAXBY- TRACMA		SCHRAMM		1239-22	CH09-12244	FCA-3005	CH05-11106
9.23.002.17	PFM-14095	25722360	CH05-11106	DRM-6200-HD-37	CH-12262	1240-05	CH10-11117	FCA-3007	CH12-12251
9.23.021.17	CH-12207	903011790	CH05-11106	STRCOUH-378	CH08-12243	1240-15	CH10-11117	FCA-3024	CH12-11389
9.23.026.17	CH-12208	E70154329	CH-15294	X-3786-P-17064	CH-12262	1242-01	CH12-12251	FCA-3025	CH14-12245
9.23.029.17	CH-12209	E70154330	CH-12507	X-378-P-17064	CH-12262	1242-05	CH12-11388	FCA-3160	CH-12213
9.23.032.17	CH-12210	E70210046	CH08-11288	SEDDON-ATKINSON		1245-01	ST05-11108	FCA-3161	CH-12660
9.23.033.17	CH-13150	E70210052	CH05-11106	42391/1	CH12-11389	1246-01	ST06-11109	FCA-3162	CH-12250
9.23.035.17	CH-13156	E70210066	ST06-11315	43327/1	CH12-12251	1246-02	ST06-11315	FCA-3162	CH-16874
9.23.036.17	CH-13157	E70210067	CH06-11295	47426/1	CH14-12245	1246-03	ST06-11109	FCA-3201	SC12-11391
9.23.041.17	CH-12260	E70210071	CH08-11288	SEDEMS		1246-0700	ST-15557	FCA-3205	CH-12980
9.23.048.17	CH12-12251	E70210077	CH08-11288	S010042783	CH08-11935	1247-0107	ST07-14270	FCA-3206	CH08-11288
9.23.051.17	CH-12262	E70210078	ST08-11316	SEMAT		1248-02	ST08-11316	FCA-3207S	ST08-11316
9.23.111.17	CH-12275	E70211103	CH10-11308	19750-1139	CH05-11106	1248-0700	ST-14183	FCA-3258	CH-12247
9.23.113.17	CH08-12221	E70211401	SC10-11317	20223	CH-13075	1248-17	ST08-11316	FCA-3259	CH-12246
9.23.130.17	CH-12273	E70211501	CH-12266	IH20223	CH-13075	1248-6807	ST08-14708	FCA-3285	CH-12498
9.23.131.17	SC-12274	E70211703	CH12-11389	SICARD		1249-02	ST09-12265	FCA-3287	SC06-11252
9.23.151.17	CH-12269	E70211803	CH09-12244	30-8016	CH-12262	1250-01	ST10-11239	FCA-3306	SC10-11317

Cross Reference by Manufacturer



MFRS. NO.	OUR NO.	MFRS. NO.	OUR NO.	MFRS. NO.	OUR NO.	MFRS. NO.	OUR NO.	MFRS. NO.	OUR NO.
FCA-3307	CH06-11295	61100190020	ST-13530	JLH101	ST08-11316	AP5569	CH-12283	A497	CH-12809
FCA-3308	CH-12276	61100190028	CH-12386	KSP0027	CH12-11389	AP6460	CH-12980	A498	SC12-11391
FCA-3309	ST06-11315	612.00.19.0002	CH-12232	KSP0028	SC12-11391	AP7108	CH-12231	A5004	CH-12397
FCA-3310	ST09-12265	612.00.19.0027	CH-12386	SUNOCO		AP8047	CH-12208	A501	CH-12278
FCA-3311	CH-12091	612.00.19.0038	CH-12232	A-42	PF-15684	AP8048	CH-13157	A506	CH-12216
FCA-3312	CH-12225	61200190033	ST-13531	A-44	PF-15683	AP9834	CH-12385	A508	CH-12215
FCA-3313	CH-12269	61200190037	CH-12385	SUZUKI		AP9835	CH-12278	A510	CH12-11389
FCA-3314	SC-12270	61200190701	CH-12232	16506-96015	CH10-11308	AR-005	CH-12209	A511	CH-12276
FCA-3315	CH09-12244	990.00.19.0137	CH-12235	T.C.M.		AR-1185	CH-12264	A522	CH-12204
FCA-3321	ST-13527	990.14.19.0033	CH-12278	20801-03101	CH10-11308	AR-2032	CH-12232	A524	CH-12225
FCA-3322	SC14-12254	99000190075	CH-12242	20801-03161	CH12-11389	AR-2710	CH-12386	A526	CH-12091
FDA-3103	CH-12207	99000190701	CH-12385	20801-03361	CH06-16050	AR-4650	CH-16873	A527	ST08-12229
FDA-3105	CH-12214	99000190702	CH-12242	T.R.S.		AR-4650/1	CH-12235	A528	CH-13150
FDA-3106	CH-13156	99012190030	ST-13529	25311500	CH04-11675	AR-4934	CH-12214	A529	CH08-12228
FDA-3110	CH-13150	99012190037	CH-12235	TADANO		AR-4935	CH-13156	A530	CH-12214
FDA-3111	CH-12210	99012190137	CH-12235	346-700-15040	SC10-11317	AR-5569	CH-12283	A532	CH-12208
FDA-3116	CH-12208	99012190196	ST-13527	346-700-15050	CH10-11308	AR-6460	CH-12980	A534	CH-13157
FDA-3117	CH-13157	99012190701	CH-12242	99701499695	CH-12235	AR-7108	CH-12231	A536	CH-13156
FDA-3139	CH-12232	99012190705	CH-12235	99708406317	CH-12980	AR-801	ST-16488	A538	CH-12210
FDA-3140	CH-12385	991.12.19.0030	ST-13529	TALBOT		AR-8047	CH-12208	A540	CH-12235
FDA-3142	CH-12248	991.12.19.0705	CH-12235	27059900	CH-12231	AR-8048	CH-13157	A541	ST-13529
FDA-3143	CH-16873	99114190025	ST-13528	TAMROCK		AR-805	ST-16487	A542	CH-12385
FDA-3144	CH-12238	STIHL		81166609	CH-12177	AR-820	ST-13531	A544	CH-12213
FDA-3156	CH-12386	42011410300	CH-12953	81721319	CH-12286	AR-830	ST-13527	A545	CH-12266
FDA-3260	CH-12242	42011410303	CH-12953	81721449	ST09-12265	AR-840	ST-13529	A546	CH12-11389
FDA-3261	CH-12231	42231410300	PF-15857	85225039	SC-12274	AR-859	SC10-11317	A548	CH-12660
FDA-3263	CH-12235	STILL		85831809	SC10-12395	AR-860	ST-13528	A550	CH-16873
FLA-3007	CH12-12251	141790	CH-12397	85832099	ST08-11316	AR-9835	CH-12278	A556	CH14-12245
FPA-3014	CH-11348	STP		86529569	CH-12790	AS801	ST-16488	A557	CH-12980
FPA-3254	PF-15684	SAF-300	PF-15684	TAYLOR MACHINE		AS805	ST-16487	A562	CH-12242
STEIGER		SAF-602	PF-15683	2403700	CH08-12243	AS810	ST-13530	A565	CH-14104
09-020	CH14-12245	SULLAIR		4044300	CH08-11003	AS820	ST-13531	A566	CH04-11675
09-026	CH12-11389	1144	CH-12385	TECAFILTRES		AS830	ST-13527	A570	CH05-12222
09-027	SC12-11391	41120	SC-12274	9450993	CH12-12251	AS840	ST-13529	A572	CH06-11295
09-029	SC12-11391	42263	CH10-12224	9450995	CH05-11106	AS860	ST-13528	A574	ST06-11315
09-060	CH10-11308	42268-1	CH14-12245	TECALEMIT-TJ		TECNOCAR		A576	CH08-12221
28-020	CH14-12245	42668	CH14-12245	B140	CH-12206	A164	CH12-11343	A580	CH08-11288
28-021	SC14-12254	42668-1	CH14-12245	B161	PF-15680	A164	CH-13477	A581	CH08-11935
45-213	CH-12269	44819	CH-12262	B77	CH-12177	A303	PF-15690	A582	ST08-11316
45-213S1	CH-12269	45141	CH-12273	B91	CH-11348	A304	PF-15693	A585	CH06-11056
45-252	CH-12266	45142	SC-12274	TEC-FIL		A396	PF-15684	A587	ST-12226
45-252S1	CH-12266	SUMITOMO		AP1185	CH-12264	A480	CH05-11106	A589	ST06-12048
STEYR-DAIMLER-PUCH		BRH0281	CH08-11288	AP2032	CH-12232	A481	CH-14387	A590	CH-12386
311.00.19.0019	ST-16488	BRH0282	ST06-11315	AP2710	CH-12386	A482	SC14-12254	A600	CH10-12224
3110019019	ST-16488	BRH0575	CH10-11308	AP4440	CH-12242	A488	CH-12268	A663	CH-11348
411.85.19.0010	CH-12231	BRH0576	SC10-11317	AP4650	CH-16873	A491	ST-13530	A-665	CH-14152
41185190007	ST-16487	BRP0027	CH12-11389	AP4650/1	CH-12235	A493	ST-13531	A700	CH-12283
44185190010	CH-12231	BRP0028	SC12-11391	AP4934	CH-12214	A494	CH-12231	A701	CH-12236
5.590.00.710.020	CH-16873	JLH0100	CH08-11935	AP4935	CH-13156	A495	ST-13527	A702	CH-11211

Cross Reference by Manufacturer



MFRS. NO.	OUR NO.	MFRS. NO.	OUR NO.	MFRS. NO.	OUR NO.	MFRS. NO.	OUR NO.	MFRS. NO.	OUR NO.
A704	CH-13520	3182-C-44G01	CH05-11106	T-10-1237	CH12-12251	TA-7427	ST06-11315	27.724.00	CH-12216
A706	CH-13510	P398991	CH05-11106	T-10-2090	CH-12260	TA-7437	CH-12268	27.748.00	CH-12215
A712	CH-12485	TIMBERJACK		T-10-3951	PF-15677	TA-7445	CH-12209	27.764.00	CH-12209
A714	CH-12491	403756	CH12-12251	T-10-5043	CH08-12221	TA-7450	CH-12209	27.793.00	CH12-11389
A717	CH09-12244	415039	CH09-12244	T-10-5368	CH08-11288	TA-7454	CH-12262	27.801.00	CH-12397
A720	CH-12248	415040	ST09-12265	T-10-6587	CH12-11389	TA-7457	CH-12262	27.802.00	CH-12385
A724	CH-12273	F434072	CH10-15371	T-10-6769	CH14-12245	TA-7467	CH-14104	27.803.00	CH-12212
A726	CH-12269	TOKYO ROKI		T-10-6834	SC12-11391	TRUCKCARE		27.804.00	CH-12386
A728	SC-12270	8113000200	CH04-11675	T-10-7672	CH14-12245	07-3-0202-0	CH-12235	27.805.00	CH-12242
A731	CH-12238	TOMI		T-10-8668	CH10-11308	07-3-0203-0	CH-12385	27.806.00	CH-12235
A732	CH10-11308	APF-3465-P	PF-15684	T-10-9085	SC-12274	07-3-0204-0	CH-12264	27.808.00	CH-12206
A734	SC10-11317	TORO		T-11-4747	CH08-12221	07-3-0205-0	CH-12242	27.820.00	CH-12210
A736	CH-12246	27-7100	CH05-11106	T-11-7797	CH-12268	07-3-0206-0	CH-16873	27.828.00	CH-12231
A737	CH-12289	27-7110	CH05-11106	T-1286	CH-13156	07-3-0220-0	CH12-11389	27.837.00	CH-12091
A742	CH-15304	932195	CH04-14412	T-1287	CH-13150	07-3-0221-0	SC12-11391	27.838.00	CH-16873
A743	CH-14380	TOWMOTOR		T-17064	CH-12262	07-3-0222-0	CH-12213	27.839.00	CH-12232
A752	CH-12276	094-6081	SC14-12254	T-46976	CH-14104	07-3-0223-0	CH-12250	27.857.00	CH-12247
A753	CH-12247	094-6353	CH12-11389	T-8047	CH-12208	07-3-0223-0	CH-16874	27.862.00	CH-12213
A758	CH-12387	645110V	CH-12386	T-9045	CH-12210	07-3-0224-0	CH14-12245	27.863.00	CH-12660
A761	CH-12278	663384	CH08-12243	T-9334	CH-12214	07-3-0225-0	SC14-12254	27.875.00	CH-12248
A764	CH-12286	668373	CH08-12243	TA-7315	CH-12177	07-3-0226-0	CH-12289	27.879.00	CH09-12244
A765	CH-12825	682994	CH10-12224	TA-7320	CH-12206	07-3-0227-0	CH-11211	27.889.00	CH-12980
A766	CH-14107	684163	CH08-12243	TA-7356	CH-12847	07-3-0228-0	CH-12283	27.892.00	CH-12276
A767	ST09-12265	686911	CH08-11003	TA-7364	CH-12208	07-3-0260-0	CH-12236	27.893.00	CH14-12245
A770	CH-13763	687743	CH10-12224	TA-7365	CH-13157	07-3-0261-0	CH-12246	27.894.00	SC14-12254
A774	CH-12282	687744	CH08-12243	TA-7366	CH-12214	07-3-0263-0	CH-12247	27.919.00	CH05-12222
TEHO FILTER		687746	CH08-12243	TA-7367	CH-13156	07-3-0280-0	ST-13531	27.922.00	CH-12208
183A	CH-12397	813923	CH12-11389	TA-7368	CH-12207	07-3-0281-0	ST-13527	27.923.00	CH10-11308
TENNANT		813957	SC12-11391	TA-7374	CH-12210	07-3-0284-0	CH-12282	27.924.00	CH05-11106
12538	CH-12269	971217	CH05-11106	TA-7375	CH-13150	07-3-0300-0	CH-12238	27.926.00	CH-12273
515601	CH05-11106	971310	CH-12209	TA-7378	CH-12262	07-3-0301-0	CH-12234	27.931.00	CH06-11056
51561	CH05-11106	971426	CH04-11675	TA-7383	CH12-12251	07-3-0320-0	CH-12278	27.932.00	CH08-11288
54141	CH05-11106	TOYOTA		TA-7386B	CH08-12243	07-3-0321-0	CH-12386	27.933.00	CH04-11675
54141-1	CH05-11106	17731-41830	CH04-11675	TA-7387	CH05-11106	07-3-0322-0	CH-12248	27.935.00	CH12-12251
TERBERG		17731-41830-71	CH04-11675	TA-7387B	CH05-11106	07-3-0323-0	ST-13529	27.936.00	CH08-12221
28040299	CH-12385	17732-41830	CH04-11675	TA-7388	CH-12260	07-3-0532-0	PF-15680	27.944.00	CH-12268
TEREX		17741-23600-71	CH-15475	TA-7392	CH04-11675	07-3-0538-0	CH08-11288	27.945.00	CH16-12253
15240188	CH-16294	17743-236007	CH-15475	TA-7392B	CH04-11675	07-3-0540-0	CH-12781	27.949.00	ST08-11316
15270188	CH-16294	17743-23600-71	CH-15475	TA-7399	PF-15677	07-3-0550-0	CH14-12245	27.950.00	CH-12302
15270189	SC-16301	17791-11120	SC-12274	TA-7401	CH08-12221	UFI		27.964.00	ST08-12229
TEXACO		17791-11120-71	CH05-11106	TA-7402	CH-12275	27.007.00	CH-12278	27.965.00	CH08-12228
TA-46	PF-15683	17791-22000-71	ST-14343	TA-7402B	CH-12275	27.014.00	ST09-12265	27.966.00	CH-11211
THERMO-KING		23612-44790	SC10-11317	TA-7404	CH08-11288	27.024.00	SC-12252	27.971.00	CH-12263
11.3331	CH05-11106	23613-44790	CH10-11308	TA-7410	CH12-11389	27.052.00	CH-12250	27.989.00	CH-12236
11-5692	CH04-11675	TRANE		TA-7413	CH14-12245	27.052.00	CH-16874	27.991.00	CH-12266
2047B-64G-01	CH05-11106	X-2409001	CH05-11106	TA-7414	SC14-12254	27.148.00	CH-14104	28.908.00	CH-11348
2068B74	CH05-11106	X-24090019	CH05-11106	TA-7415	CH05-11106	27.217.00	CH-15673	30.851.00	PF-15684
2091-B-09G01	CH05-11106	TRU-AIR		TA-7417	SC-12274	27.707.00	CH-11348	UNI DIESEL	
2091-B-09H06	CH05-11106	T-10-0890	CH-12262	TA-7418	CH-12273	27.723.00	CH-12249	4.581135.3	CH14-12245

Cross Reference by Manufacturer



MFRS. NO.	OUR NO.	MFRS. NO.	OUR NO.	MFRS. NO.	OUR NO.	MFRS. NO.	OUR NO.	MFRS. NO.	OUR NO.
4.581576.3	CH16-12253	U4M-8048	CH-13157	CPD7157	CH-12980	200867-004	CH06-14733	11033783-9	ST-13529
4.581641.2	SC14-12254	U4M-9334	CH-12214	CPD7177	CH-12500	2143-003	CH05-11106	11110022	CH-14888
4.582229.8	SC-12252	U4M-9335	CH-13156	CPD7178	CH-12279	2150-007	CH08-11003	11992462-9	CH-12980
UNION 76		U4M-9376	CH-12207	CPD7233	CH06-14733	28918-005	SC-12274	12000189	CH14-12245
575	PF-15683	U7M-9045	CH-12210	CPD7244	CH-12794	28918-0051	SC-12274	1542743	CH-12283
UNIPART		U7M-9046	CH-13150	CPM8006	PF-15688	28918009	CH-12273	1542743-8	CH-12283
GFE1102	CH-12857	V-250D253FS	CH-13141	VPD 7124	CH08-11288	66544-001	SC-12270	1544298	CH-12302
GFE1202	CH12-11389	UNITED ENGINE LIFE		VPD 7141	CH-13075	85632-009	CH-12269	1544298-1	CH-12302
GFE1204	PF-15680	CP-4N0015	PF-14090	VPD7003	CH-12209	901498-003	CH09-12244	1544428	CH-11211
GFE1206	CH08-11288	CP-4N0015	PFM-14095	VPD7012	CH-12867	901498-007	ST09-12265	1584575-3	PF-15686
GFE2102	CH12-11389	CP-6L4714	PF-15677	VPD7015	CH-12485	905427-005	CH04-11675	1660375	CH-11211
UNIT RIG		UNITED TRACTOR & E		VPD7016	CH-12491	97611-005	CH06-14733	1660375-5	CH-11211
900417	CH-12260	UT-37441	CH05-11106	VPD7022	CH-12209	VERSATILE		1660602	CH-12289
901157	CH-12266	UT-41251	CH08-12243	VPD7026	CH06-11056	30924	CH-12273	1660602-2	CH-12289
901619	CH21-17070	V.A.G. (VOLKSWAGEN,		VPD7029	CH-12275	30927	SC-12274	1660619	CH-12283
901620	SC21-17075	044 129 620 A	CH-12285	VPD7033	CH-12231	601-T-125	CH-12262	1660619-6	CH-12283
UNITED AIR CLEANER		070129620	CH-12397	VPD7034	CH-12386	VIC		1661667	CH-12093
250C110-S	CH-12209	075129620A	CH-12386	VPD7036	ST06-12048	A352	CH10-12224	1661667-4	CH-12093
250C118-S	CH-12209	113129620A	CH-12397	VPD7038	ST-16487	A353	CH10-11308	21-736-2224	CH-12385
250C131-S	CH14-13356	1H0129620	CH-12272	VPD7039	ST-16488	A366	CH14-12245	347138	CH-12826
250C152	ST08-11110	VALMET		VPD7040	ST-13530	A367	SC14-12254	3471380	CH-12826
250C5-S	CH-12209	836115237	CH-12980	VPD7045	CH08-11942	A558S	CH12-12251	347436	CH-12213
250C65-S	CH-12209	836316408	CH-12385	VPD7056	ST06-12048	A564	CH12-11389	347437	CH-12660
250D27-S	SC14-13357	VALVOLINE		VPD7061	ST08-11316	A565	SC12-11391	355994	CH-12213
250D29-S	CH-12268	VA-40	PF-15683	VPD7062	ST08-11316	A609	CH-12273	3576571	CH08-11935
U0-0890	CH-12262	VA-54	PF-15684	VPD7063	ST-12226	VM		360224	CH-12250
U0-1237	CH12-12251	VA-69	PF-15684	VPD7069	CH-12386	41130007A	CH10-11308	360224	CH-16874
U0-1275	CH05-11106	VAN HOOL		VPD7073	ST08-12229	41130008A	CH06-11295	362264	CH-12250
U0-1760	CH06-11038	631200870	CH12-11389	VPD7074	CH08-12228	41132011A	CH08-11288	362264	CH-16874
U0-2090	CH-12260	631201530	CH-12235	VPD7075	CH-12385	41132013A	SC10-11317	460406	CH-12233
U0-2745	CH04-11675	631202860	CH-12234	VPD7076	ST-13531	VME (VOLVO BM/MICH./		475081	CH14-12245
U0-5043	CH08-12221	631401380	CH-12238	VPD7078	SC10-11317	11005897	PF-15686	475190	CH12-11389
U0-5054	CH-12275	920920110	CH-16294	VPD7079	CH-12091	11005897-1	PF-15686	475191	SC12-11391
U0-6587	CH12-11389	9933276	CH14-12245	VPD7084	ST-16876	11033129	ST-13528	475220	CH-12250
U0-6769	CH14-12245	VAPORMATIC		VPD7086	CH08-11288	11033777	ST-13530	475220	CH-16874
U0-6775	SC14-12254	CPD7012	CH-12867	VPD7087	CH06-12258	11033779	ST-13531	475230	CH-12250
U0-6834	SC12-11391	CPD7015	CH-12485	VPD7091	CH06-11941	11033781	ST-13527	475230	CH-16874
U0-7868	CH08-11288	CPD7026	CH06-11056	VPD7093	CH-13185	11033783	ST-13529	475338	CH-12213
U0-8668	CH10-11308	CPD7029	CH-12275	VPD7097	CH-13270	4881174	CH-12266	475339	CH-12660
U0-8674	SC10-11317	CPD7038	ST-16487	VPD7100	CH-12653	6241405	CH18-17230	475386	CH-12283
U0-8736	CH05-12222	CPD7040	ST-13530	VPD7129	ST-13527	6241406	SC18-17232	475618	CH-12250
U0-9085	SC-12274	CPD7078	SC10-11317	VPD7150	CH12-11343	6644991	CH-12242	475618	CH-16874
U0-9155	CH-12266	CPD7124	CH08-11288	VPD7150	CH-13477	966538	CH-12266	475755	CH-11211
U0-9200	CH-12269	CPD7129	ST-13527	VPD7152	CH-12790	M12000149	CH-12273	4758610	CH-12386
U1-3343	SC10-12395	CPD7141	CH-13075	VPD7157	CH-12980	VOLKSWAGEN		475975	CH-12289
U1-3501	CH-14104	CPD7143	SC10-12395	VPD7178	CH-12279	1H0129620	CH-12272	475975-9	CH-12289
U1-9370	SC-12274	CPD7150	CH12-11343	VPD7233	CH06-14733	VOLVO		476769	CH-12213
U4M-383	CH-12208	CPD7150	CH-13477	VPM8006	PF-15688	1080920	ST-16938	476769-5	CH-12213
U4M-3976	CH-12207	CPD7152	CH-12790	VERMEER		11033129-5	ST-13528	4771477	PF-15686

Cross Reference by Manufacturer



MFRS. NO.	OUR NO.	MFRS. NO.	OUR NO.	MFRS. NO.	OUR NO.	MFRS. NO.	OUR NO.	MFRS. NO.	OUR NO.
4771477-9	PF-15686	79384780	SC14-12254	VJ-5176	SC21-17075	0199421	CH09-12244	SA-423	ST08-11316
4780961	CH-12385	8143691	PF-15441	VP-0357	CH12-11389	207965	CH06-14733	SA-430	SC10-11317
4785610	CH-12386	8143691-7	PF-15441	VS-1956	CH10-11308	493016	CH09-12244	SA-434	CH08-11288
4785610-9	CH-12386	8144430	PF-15441	VS-1968	CH12-11389	493017	CH06-14733	SA-435	CH-12282
4785611	ST-13530	8293904	CH08-11288	VS-2317	SC-12270	WAUSAU IRON		SA-448	CH09-12244
4785611-7	ST-13530	858488	CH-15005	VS-2318	CH-12269	201415	CH10-11308	SA-449	ST09-12265
4785612	CH-12386	900691	CH-12385	VS-2395	SC10-11317	WAYNE		SA-469	CH06-11295
4785746	ST-13527	VOLVO CONSTRUCTIO		VY-8537	CH-12273	604334	CH05-11106	SA-79	CH-12262
4785746-1	ST-13527	11007388	PF-15686	VY-8538	SC-12274	WEATHERHILL		SA-97-A	CH12-12251
4785748	CH-12235	11007388-9	PF-15686	VY-9209	CH14-12245	10/2327	CH12-11389	WHITE	
4785748-7	CH-12235	11033777	ST-13530	VY-9210	SC14-12254	WERKLUST		02-7074164	CH12-11389
4785749	ST-13529	11033777-1	ST-13530	WA-6622	CH-12262	6962224	CH12-11389	02-7074252	CH14-12245
4785749-5	ST-13529	11033996	CH-16294	X43-545	CH10-11308	6962225	SC12-11391	02-7074453	CH12-12251
4785921	SC-12252	11033997	SC-16301	X43-564	CH12-12251	WGB		02-7074458	CH12-11389
4785922	CH16-12253	11110023	SC-16290	WABCO HOUSINGS		SA-100	CH05-11106	02-7074463	CH-12262
4880631	CH-12276	11110149	ST-13531	TA-2324	CH-12260	SA-100-A	CH05-11106	02-7075128	CH16-12253
4880632	SC10-11317	1584575	PF-15686	VF-1364	CH-12260	SA-107	CH-12262	02-7077554	CH-12268
6612504	CH-12213	3570821	CH-12500	VH-4812	CH-12260	SA-109	CH-12262	10A-19708	CH08-12243
6639203	CH-12839	3570822	CH-12279	VP-4365	CH12-11389	SA-110	CH-13157	10P-2652	CH12-12251
6639203-6	CH-12839	362224-8	CH-12385	VP-4711	CH10-11308	SA-112	CH-12260	1156603	CH08-12243
6640289	CH-12235	M12000149	CH-12273	VP-4712	CH14-12245	SA-113	CH-12214	1190153	CH08-12243
6642047	ST-13531	VOLVO-BM		VP-7377	CH10-11308	SA-128	CH-12208	1196733	CH08-12243
6644839	CH-12386	11033779-7	ST-13531	VS-630	CH-12260	SA-130	CH-13156	157959-AS	CH08-12243
6644840	ST-13530	11033781-3	ST-13527	VS-6300	CH-12260	SA-131	CH-12207	159089-A	CH08-11288
6644988	ST-13531	11033783-9	ST-13529	VY-5281	CH14-12245	SA-133	CH-12210	160170	CH-12262
6644988-5	ST-13531	11033996-7	CH-16294	WAGNER MINING		SA-134	CH-13150	160170-AS	CH-12262
6644990	CH-12242	11033997-5	SC-16301	328181	CH08-12243	SA-146	CH-12209	162814-AS	CH08-12243
6644990-1	CH-12242	40123606	SC-12274	328185	CH08-12243	SA-15	PF-14090	166068-A	SC10-12395
6645119	CH12-11389	VORTEX		346396	CH14-12245	SA-15	PFM-14095	167067-A	CH10-11308
6645119-6	CH12-11389	VF-160R	CH-11020	346397	SC14-12254	SA-188	CH-12262	167068-A	SC10-12395
6645833	ST-13531	VORTEX HOUSING		346398	CH14-12245	SA-194	CH-12262	20-3004805	CH05-11106
6897064	CH-12225	AN-150-H	CH-11020	346399	SC14-12254	SA-209	CH-11348	20-3004926	CH05-11106
7008166	CH10-11308	WABCO		347686	CH08-12243	SA-229	CH-12275	20-7000615	SC12-11391
7009363	CH08-11288	4035541	CH-12266	360956	CH12-11389	SA-229-A	CH-12275	20-7002172	CH10-11308
7009375	SC10-11317	475599	CH-12262	WAKO		SA-243	CH-12260	20-7300768	CH05-11106
7009410	ST08-11316	728339	CH-12262	LA-288	CH12-12251	SA-263	CH12-11389	2951-H2-4	CH-12262
7362224	CH-12385	728340	CH-12262	LA-367S	CH10-12224	SA-270	SC14-12254	30-2012251	CH12-11389
7362224-3	CH-12385	CK-8849-1	CH-12262	LA-368	CH10-11308	SA-278	CH08-12221	30-2012324	SC12-11391
7475191	SC12-11391	VH-3179	CH-12260	LA-368S	CH10-11308	SA-283	CH14-12245	30-3070342	CH10-11308
7475191-8	SC12-11391	VJ-0560	CH12-11389	LA-773	CH-12215	SA-294	CH08-12243	30-3070352	CH10-11308
79199899	CH-12260	VJ-0561	SC12-11391	WALDON		SA-330	PF-15677	3107368-H2	CH12-11389
79200549	CH-12266	VJ-1881	CH14-12245	042770	CH05-11106	SA-334	SC12-11391	31-2755007	CH09-12244
79205191	CH-12232	VJ-1882	CH12-11389	042796	CH05-11106	SA-368	CH-12268	31-2755017	ST09-12265
79230041	CH-12260	VJ-1884	SC14-12254	055574	CH08-12243	SA-374	CH05-12222	31-2755067	CH10-11308
79253654	SC-12274	VJ-1885	SC12-11391	WARNER & SWASEY		SA-380	CH14-12245	31-2755077	SC10-11317
79253662	CH-12273	VJ-2325	SC-12274	251429	CH12-12251	SA-387	CH-12177	31-2755087	CH10-11308
79258257	CH12-12251	VJ-3024	CH-12260	650156	CH08-12243	SA-418	CH10-11308	31-2990561	CH08-12228
79359626	CH-12242	VJ-5139	CH-12266	WAUKESHA		SA-420	CH-14104	3314-H2	CH12-12251
79384772	CH14-12245	VJ-5175	CH21-17070	0199206	CH05-11106	SA-422	CH08-11288	3341-H2	CH12-12251

Cross Reference by Manufacturer



MFRS. NO.	OUR NO.	MFRS. NO.	OUR NO.	MFRS. NO.	OUR NO.	MFRS. NO.	OUR NO.	MFRS. NO.	OUR NO.
35A-8197	CH05-11106	42321	CH08-11288	46313	CH-12397	46852	CH-12289	DT-8048	CH-13157
35A-8260	CH05-11106	42334	CH-12214	46327	CH-12272	46868	CH-11020	DT-9045	CH-12210
35P-1601	CH05-11106	42335	CH-13156	46328	CH-12247	47047	CH10-12224	DT-9046	CH-13150
40A-134	CH05-11106	42336	CH-13141	46330	CH-12285	47048	SC-12252	DT-9334	CH-12214
505001	CH-12262	42342	CH-12272	46351	CH-12213	47052	CH16-12253	DT-9335	CH-13156
640114	CH08-11288	42378	CH-12207	46352	CH-12403	542653	CH06-12258	DT-9378	CH-12207
664578	CH05-11106	42489	CH05-11467	46360	CH05-11106	546683	CH08-11935	WOODGATE	
6DD-0330	CH-12262	42503	CH08-12221	46375	ST08-11110	751754	CH08-11935	WGA100	CH-12214
703112	CH08-12243	42505	CH-12209	46378	CH-12605	A-10	CH-12839	WGA1028S	ST-16938
789554	CH-12262	42508	CH-12282	46407	ST-14715	A-108	PF-15680	WGA1029	CH-12093
882681	CH-12262	42518	CH06-14733	46408	CH-12485	A-11	CH-12206	WGA1030K	CH10-12390
888686	CH-12262	42522	CH09-12244	46414	CH-12248	A-116	CH-12235	WGA1030K	CH10-14455
896688	CH12-12251	42540	CH-12275	46430	CH-12231	A-122	CH12-12251	WGA1032	PF-15686
896688-H2	CH12-12251	42550	CH-12209	46466	CH08-12228	A-123	CH-12262	WGA1042	CH08-11942
CM-94	CH05-11106	42595	PF-15677	46467	ST08-12229	A-124	CH-12653	WGA1049K	CH-12345
P-2881	CH-12262	42608	CH-12235	46487	CH08-12228	A-130	CH-12260	WGA105	CH-12249
X-27780	PF-15677	42609	ST-13529	46496	CH-12716	A-133	CH-12266	WGA1050S	ST06-12048
Y-531281	CH12-12251	42618	CH-12268	46498	CH-12491	A-139	CH-12397	WGA1054K	CH-13824
WIPAC		42630	CH-12177	46502	CH-14722	A-144	CH-12249	WGA1057	CH-15300
AP113	PF-15680	42631	CH06-11056	46504	CH-14334	A-146	SC14-12254	WGA1060	CH-12825
AP367	PF-15684	42632	ST-12226	46510	CH-12225	A-148	CH-12212	WGA107	CH-12283
AP903	CH05-11106	42645	CH04-11675	46515	CH-12386	A-149	CH08-11288	WGA1070S	CH-12225
WISCONSIN		42653	CH06-12258	46517	ST-13410	A-150	CH-12231	WGA1072	CH-15565
EP-78	CH05-11106	42656	CH14-13356	46522	ST08-11316	A-152	CH-12385	WGA1075K	CH06-11880
LO-176	CH05-11106	42657	SC14-13357	46525	ST-13531	A-154	CH-12660	WGA1077S	ST05-14402
WIX		42679	ST06-11315	46526	CH06-11941	A-156	CH-12246	WGA1079	CH07-14074
15295	CH-12273	42710	CH-12839	46532	ST-13530	A-157	CH-12209	WGA108	CH-12260
211A	CH-12839	42764	CH-12262	46534	CH-12867	A-159	SC12-11391	WGA1080	CH08-14410
42042	PF-14090	42769	ST-14343	46537	CH08-12228	A-160	CH-12386	WGA1083S	CH-13520
42042	PFM-14095	42811	CH-12206	46538	ST08-12229	A-161	CH-12242	WGA1087	CH-12716
42045	CH-12210	42868	CH08-11288	46541	CH-12242	A-162	CH-12246	WGA108E	CH-12260
42046	CH-13150	42878	CH-12249	46546	CH-12232	A-166	CH-12213	WGA1091S	ST06-12048
42047	CH-12208	42890	CH-12262	46547	CH-12283	A-168	CH-12264	WGA1093	CH-13763
42048	CH-13157	42918	CH-14104	46554	CH-12385	A-32	CH-11348	WGA1094	CH-12790
42119	CH12-11389	42919	CH10-11308	46560	ST09-12265	A-55	CH-12177	WGA11	CH-12262
42123	CH05-12222	42920	SC10-11317	46561	CH-12286	A-58	CH-12213	WGA1109	CH06-16050
42133	PF-15684	42921	SC10-12395	46562	ST08-12229	A-65	CH-12660	WGA111	CH-12242
42142	CH08-11003	42924	SC12-11391	46569	ST08-14413	A-66	CH12-11389	WGA111S	ST-13527
42208	CH14-12245	42927	CH-12269	46580	PF-14090	A-76	CH-12177	WGA112	CH-12216
42209	SC14-12254	42928	SC-12270	46580	PFM-14095	A-85	CH14-12245	WGA113	CH-12385
42225	CH-12273	42966	CH-12268	46594	CH-12234	AK-120	CH05-11106	WGA113S	ST-13531
42226	SC-12274	46120	PF-15683	46606	CH06-11295	DT-0890	CH-12262	WGA114	CH-12386
42237	CH12-12251	46133	PF-15684	46613	CH-13270	DT-1237	CH12-12251	WGA114S	ST-13530
42238	CH21-17070	46188	CH-12206	46625	CH08-11942	DT-1275	CH05-11106	WGA1179	CH-15304
42239	SC21-17075	46210	CH-12847	46642	CH-12276	DT-17064	CH-12262	WGA122	CH-12208
42258	CH18-17230	46263	ST05-14980	46643	SC10-11317	DT-2090	CH-12260	WGA125	CH-12397
42259	SC18-17232	46270	CH04-11675	46652	CH07-14074	DT-42	PF-14090	WGA128	CH-12231
42276	CH05-11106	46274	CH-12215	46672	ST07-14270	DT-42	PFM-14095	WGA128S	ST-16487
42290	CH-12260	46294	CH-12091	46741	CH-12278	DT-8047	CH-12208	WGA129K	CH10-11308

Cross Reference by Manufacturer















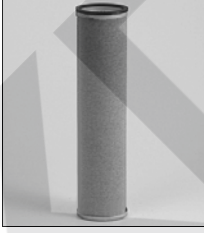
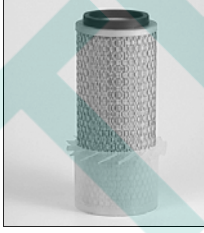

MFRS. NO.	OUR NO.	MFRS. NO.	OUR NO.	MFRS. NO.	OUR NO.	MFRS. NO.	OUR NO.	MFRS. NO.	OUR NO.
WGA129KE	CH10-11308	WGA307E	CH-12269	WGA478K	CH05-11467	CLE-390	CH09-12244	6953105	SC12-11391
WGA129S	SC10-11317	WGA307S	SC-12270	WGA478S	ST-13410	ELM-43	CH-12262	6953106	SC14-12254
WGA12KE	CH06-11038	WGA309K	CH06-11295	WGA486	CH-13185	ELM-44	CH05-11106	6953107	CH14-12245
WGA12S	ST-14343	WGA309KE	CH06-11295	WGA494K	CH-12688	ELM-54	CH10-11308	8403756	CH12-12251
WGA130	CH-12268	WGA309S	ST06-11315	WGA54E	CH16-12253	ELM-56	SC10-11317	8407839	CH10-12224
WGA131	CH-12826	WGA30E	CH14-12245	WGA599	CH-14104	ELM-74	ST08-11316	901515400	CH05-11106
WGA133	CH-12980	WGA30S	SC14-12254	WGA605S	CH-12605	ELM-78	CH09-12244	902225300	CH05-11106
WGA135	PF-15680	WGA312	CH-12212	WGA670	CH-11020	ELM-79	ST09-12265	YANMAR	
WGA136	CH-12213	WGA318	CH-12210	WGA835	ST08-11110	ELM-85	CH04-11675	114650-12591	CH-16888
WGA13KE	CH10-12224	WGA319	CH-12207	WGA87	CH-12264	XSV		121120-12001	CH-14393
WGA142	CH-12206	WGA325	CH-12278	WGA878	PF-15684	OPA3192	PF-15683	121120-12901	CH05-11106
WGA143	CH-11211	WGA330	CH-12285	WGA90	CH-12246	OPA3465	PF-15684	12122-012901	CH05-11106
WGA144	CH-12289	WGA331	CH-12225	WGA91	CH-12236	YALE & TOWNE		121256-12510	CH05-11106
WGA148	CH-12215	WGA331S	ST-16876	WGA921	CH-12953	0105025	CH08-12243	121420-12511	CH05-11106
WGA14K	CH12-12251	WGA334	CH-12238	WGA927	CH-12798	0403756	CH12-12251	121520-12510	CH04-11675
WGA152	CH-12839	WGA338K	CH08-12221	WGA927S	SC10-12395	0653785	CH05-11106	121922-12510	CH08-11288
WGA155	CH-12209	WGA338KE	CH08-12221	WGA928	CH-13074	103059	CH08-12243	124066-12510	CH04-11675
WGA15K	CH05-11106	WGA339KE	CH09-12244	WGA96	CH-12235	1297646	CH05-11106	126652-12620	CH12-11389
WGA15KE	CH05-11106	WGA340KE	CH08-12228	WGA964K	CH-13811	1500127-00	CH05-11106	126654-12620	SC14-12254
WGA160S	ST-16488	WGA340S	ST08-12229	WGA96S	ST-13529	1500229-00	CH-12209	126654-12630	CH14-12245
WGA161K	CH06-12258	WGA343	CH-13157	WGA97	CH-12248	1500231-00	CH05-11106	171022-12530	CH04-11675
WGA168	CH-12781	WGA344	CH-13150	WGA986	CH-14107	1500716-00	CH05-11106	2330387307	CH05-11106
WGA16KE	CH08-11003	WGA345	CH-13156	WGA987	CH-14104	2022514	CH12-12251	416505-50810	CH-14237
WGA16S	ST08-11110	WGA355	CH-12091	WGA989	CH-13090	2047874	CH08-12243	521520-12510	CH04-11675
WGA171K	CH05-12222	WGA372K	CH-12275	WGA991	CH-14334	2078387	CH10-11308	ZETOR	
WGA178	CH-12752	WGA376	CH-12271	WGA993	CH-12857	2990511	CH-12262	10011906	CH-12385
WGA179	CH-12232	WGA378K	CH04-11675	WGA995	CH-12498	2991489	CH12-12251	10011907	ST-13531
WGA18	CH12-11389	WGA382K	CH06-11056	WGA998	CH-13050	2991764	CH12-11389	7901-1296	ST06-12048
WGA183	CH-12247	WGA382S	ST-12226	WGS236	CH-13141	2992216	CH14-12245	ZETTELMAYER	
WGA189	CH08-11288	WGA395	CH-13141	WOODS & COPELAND		440042467	CH10-11308	0 220 31600	ST-16488
WGA18E	CH12-11389	WGA400	CH14-13356	450613	CH-12266	440042468	SC10-11317	2061350	CH-12231
WGA18S	SC12-11391	WGA400S	SC14-13357	WORLDPARTS		440051973	CH05-11106	20613504	CH-12231
WGA194	CH-12867	WGA406	CH21-17070	W27-587	PF-15684	440052940	CH-12397	2078240	CH-12386
WGA205	CH-12177	WGA406S	SC21-17075	W27-636	PF-15683	440056440	CH08-11288	20782403	CH-12386
WGA206	CH-12234	WGA412K	CH10-11308	W27-676	PF-15683	440056441	ST08-11316	2078241	CH-12980
WGA207E	CH-12266	WGA434	PF-15677	WORTHINGTON		5040251	CH08-12243	20782411	CH-12980
WGA21	CH-12653	WGA439S	CH-12302	11453900	CH-16294	5069734-01	CH08-12243	2121270	CH-12232
WGA22K	CH08-11288	WGA440	CH-11211	522082536	CH-12712	5095818-01	CH-12209	21212708	CH-12232
WGA22S	ST08-11316	WGA441	CH-12289	522082537	CH-12713	5125568-00	CH-12262	2137030	CH-12397
WGA26	CH-12250	WGA442	CH-12283	522082538	CH-13948	5158658-00	CH05-11106	2240880	CH-12242
WGA26	CH-16874	WGA443	CH-12282	522082539	CH-13947	5159998-00	CH-12209	22408800	CH-12242
WGA29	CH-12660	WGA453K	CH06-11941	522082544	CH05-14827	5300504	CH05-11467	2240890	ST-13527
WGA30	CH14-12245	WGA454	CH-12809	WORTHINGTON PUMP		6537850	CH05-11106	22624805	ST-13530
WGA301	CH-12286	WGA-462K	CH-13270	522082536	CH-12712	6950541	CH-12262		
WGA301S	ST09-12265	WGA466S	CH-12485	522082537	CH-12713	6951549	CH-12260		
WGA303	CH-12276	WGA467K	CH08-11935	522082538	CH-13948	6952789	CH10-11308		
WGA304E	CH-12273	WGA470S	ST-14787	522082539	CH-13947	6953030	CH16-12253		
WGA304S	SC-12274	WGA477	CH18-17230	522082544	CH05-14827	6953031	SC-12252		
WGA307	CH-12269	WGA477S	SC18-17232	CLE-371	CH05-11106	6953104	CH12-11389		

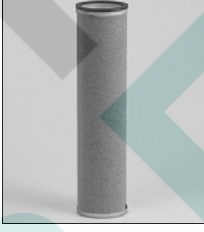
PRODUCT GUIDE

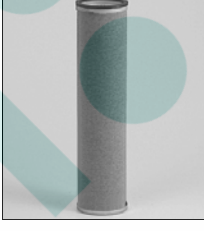
L'altezza non include la guarnizione/ Height not include gasket
 O.D. = diam. est. I.D. = diam. int.; Upper = Superiore ; Lower = Inferiore
 * = Cartuccia in rete metallica / Metallic net element
 ◇ = Cartuccia con termini di consegna a richiesta / Element with lead time to agree





















<p>CH-10677</p>  <p>Carraro (Carraro/Renault) 45401</p> <p>Overall Height: 237 (9,33) Upper O.D.: 164 (6,46) Upper I.D.: 86 (3,39) Lower I.D.: 8,5 (0,33)</p>	<p>CH-11063</p>  <p>Overall Height: 120 (4,72) Upper O.D.: 69 (2,72) Upper I.D.: 26 (1,02)</p>	<p>CH-11210</p>  <p>Fini 17025</p> <p>Overall Height: 55 (2,17) Upper O.D.: 140 (5,51) Upper I.D.: 94 (3,70)</p>
<p>CH-10689</p>  <p>Franco Perlini</p> <p>Overall Height: 223 (8,78) Upper O.D.: 183 (7,20) Upper I.D.: 106 (4,17) Lower I.D.: 9,5 (0,37)</p>	<p>CH05-11106</p>  <p>Donaldson SMP18-1050 (For Inner Air Use ST05-11108)</p> <p>Overall Height: 253 (9,96) Upper O.D.: 130 (5,12) Lower O.D.: 104 (4,09) Upper I.D.: 63 (2,48) Lower I.D.: 18 (0,71)</p>	<p>CH-11211</p>  <p>Volvo 1660375</p> <p>Overall Height: 568 (22,36) Upper O.D.: 265 (10,43) Upper I.D.: 153 (6,02) Lower I.D.: 17 (0,67)</p>
<p>CH08-11003</p>  <p>Donaldson P11-8160; XLP18-2054</p> <p>Overall Height: 304 (11,97) Upper O.D.: 197 (7,76) Lower O.D.: 155 (6,10) Upper I.D.: 88 (3,46) Lower I.D.: 18 (0,71)</p>	<p>ST05-11108</p>  <p>Sofiltra 1245-01; Fai - Fki 848100083 (For Outer Air Use CH05-11106)</p> <p>Overall Height: 242 (9,53) Upper O.D.: 62 (2,44) Upper I.D.: 52 (2,05) Lower I.D.: 8,5 (0,33)</p>	<p>CH-11219</p>  <p>Gnutti 040230321</p> <p>Overall Height: 190 (7,48) Upper O.D.: 104 (4,09) Lower O.D.: 130 (5,12) Upper I.D.: 63 (2,48) Lower I.D.: 19 (0,75)</p>
<p>CH-11020</p>  <p>Donaldson 8PP-42361-00 Painting Plants</p> <p>Overall Height: 662 (26,06) Upper O.D.: 324 (12,76) Upper I.D.: 214 (8,43) Lower I.D.: 13 (0,51)</p>	<p>ST06-11109</p>  <p>Case E41535;Sofiltra 1246-01; Fai - Fki 48101105 (For Outer Air Use CH06-11038)</p> <p>Overall Height: 262 (10,31) Upper O.D.: 66 (2,60) Upper I.D.: 56 (2,20) Lower I.D.: 8,5 (0,33)</p>	<p>ST10-11239</p>  <p>Sofiltra 1250-01; (For Outer Air Use CH10-11117)</p> <p>Overall Height: 330 (12,99) Upper O.D.: 120 (4,72) Lower O.D.: 85 (3,35) Upper I.D.: 79 (3,11) Lower I.D.: 10,5 (0,41)</p>
<p>CH06-11038</p>  <p>Donaldson P11-9775; XLP18-2052</p> <p>Overall Height: 280 (11,02) Upper O.D.: 162 (6,38) Lower O.D.: 134 (5,28) Upper I.D.: 68 (2,68) Lower I.D.: 19 (0,75)</p>	<p>ST08-11110</p>  <p>Sofiltra 1248-01; Fai - Fki 48101105 (For Outer Air Use CH08-11003)</p> <p>Overall Height: 287 (11,30) Upper O.D.: 85 (3,35) Upper I.D.: 75 (2,95) Lower I.D.: 8,5 (0,33)</p>	<p>SC06-11246</p>  <p>Cesab 0991323; Carraro (For Outer Air Use CH06-11255)</p> <p>Overall Height: 262 (10,31) Upper O.D.: 90 (3,54) Upper I.D.: 60 (2,36) Lower I.D.: 8,5 (0,33)</p>
<p>CH06-11056</p>  <p>IHC 924778-C2; Same2.4249.170.1; Donaldson E50-1042; (For Inner Air Use ST-12226 or SC06-11252)</p> <p>Overall Height: 304 (11,97) Upper O.D.: 160 (6,30) Lower O.D.: 134 (5,28) Upper I.D.: 92,5 (3,64) Lower I.D.: 18 (0,71)</p>	<p>CH10-11117</p>  <p>Sofiltra 1248-01; Fai - Fki 48101105 (For Inner Air Use ST10-11239)</p> <p>Overall Height: 344 (13,54) Upper O.D.: 255 (10,04) Lower O.D.: 201 (7,91) Upper I.D.: 90 (3,54) Lower I.D.: 19 (0,75)</p>	<p>SC06-11252</p>  <p>Massey-Ferguson 1698375-M1; (For Outer Air Use CH06-11056)</p> <p>Overall Height: 290 (11,42) Upper O.D.: 90 (3,54) Upper I.D.: 60 (2,36) Lower I.D.: 8,5 (0,33)</p>

PRODUCT GUIDE

L'altezza non include la guarnizione/ Height not include gasket
 O.D. = diam. est. I.D. = diam. int.; Upper = Superiore ; Lower = Inferiore
 * = Cartuccia in rete metallica / Metallic net element
 ◇ = Cartuccia con termini di consegna a richiesta / Element with lead time to agree

















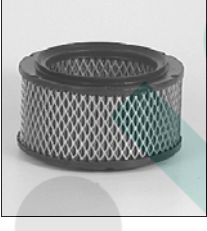

<p>SC08-11253</p> <p>Carraro 45452 (For Outer Air Use CH08-11254)</p>  <p>Overall Height: 290 (11,42)</p> <p>Upper O.D.: 90 (3,54) Lower O.D.: 60 (2,36)</p> <p>Upper I.D.: 60 (2,36) Lower I.D.: 8,5 (0,33)</p>	<p>CH10-11308</p> <p>Cummins 196677; Allis-Chalmers 654409; (For Inner Air Use SC10-11317)</p>  <p>Overall Height: 408 (16,06)</p> <p>Upper O.D.: 255 (10,04) Lower O.D.: 201 (7,91)</p> <p>Upper I.D.: 135 (5,31) Lower I.D.: 19 (0,75)</p>	<p>CH-11360</p>  <p>Overall Height: 95 (3,74)</p> <p>Upper O.D.: 183 (7,20)</p> <p>Upper I.D.: M6 Lower I.D.: 107 (4,21)</p>
<p>CH08-11254</p> <p>Carraro 45409</p>  <p>Overall Height: 304 (11,97)</p> <p>Upper O.D.: 197 (7,76) Lower O.D.: 155 (6,10)</p> <p>Upper I.D.: 92,5 (3,64) Lower I.D.: 18 (0,71)</p>	<p>ST06-11315</p> <p>Massey-Ferguson 1037735-M91; (For Outer Air Use CH06-11295)</p>  <p>Overall Height: 352 (13,86)</p> <p>Upper O.D.: 91 (3,58) Lower O.D.: 85 (3,35)</p> <p>Upper I.D.: 74 (2,91) Lower I.D.: 17 (0,67)</p>	<p>CH-11371 ◇</p> <p>Piovan 6151220; (Replaced By CH-13579)</p>  <p>Overall Height: 205 (8,07)</p> <p>Upper O.D.: 164 (6,46)</p> <p>Upper I.D.: 86 (3,39) Lower I.D.: 8,5 (0,33)</p>
<p>CH06-11255</p> <p>Fiat H. 151849501; Carraro 45450; New Holland 151849501 (For Inner Air Use SC06-11269)</p>  <p>Overall Height: 280 (11,02)</p> <p>Upper O.D.: 162 (6,38) Lower O.D.: 134 (5,28)</p> <p>Upper I.D.: 92,5 (3,64) Lower I.D.: 19 (0,75)</p>	<p>ST08-11316</p> <p>Massey-Ferguson 1093683-M91; (For Outer Air Use CH08-11288)</p>  <p>Overall Height: 355 (13,98)</p> <p>Upper O.D.: 106 (4,17) Lower O.D.: 85 (3,35)</p> <p>Upper I.D.: 74 (2,91) Lower I.D.: 17 (0,67)</p>	<p>CH12-11388</p> <p>Sofiftra 1242-05 (For Inner Air Use ST10-11390)</p>  <p>Overall Height: 345 (13,58)</p> <p>Upper O.D.: 294 (11,57) Lower O.D.: 234 (9,21)</p> <p>Upper I.D.: 124 (4,88) Lower I.D.: 16,5 (0,65)</p>
<p>SC06-11269</p> <p>Fiat H. 151849502; Carraro 45449; New Holland 151849502 (For Outer Air Use CH06-11255)</p>  <p>Overall Height: 262 (10,31)</p> <p>Upper O.D.: 90 (3,54)</p> <p>Upper I.D.: 60 (2,36) Lower I.D.: 8,5 (0,33)</p>	<p>SC10-11317</p> <p>Donaldson P11-9375; (For Outer Air Use CH10-11308 Or CH-11276)</p>  <p>Overall Height: 397 (15,63)</p> <p>Upper O.D.: 145 (5,71) Lower O.D.: 117 (4,61)</p> <p>Upper I.D.: 88 (3,46) Lower I.D.: 17 (0,67)</p>	<p>CH12-11389</p> <p>Fiat-Allis 73050258, 70660360; (For Inner Air Use SC12-11391)</p>  <p>Overall Height: 330 (12,99)</p> <p>Upper O.D.: 234 (9,21)</p> <p>Upper I.D.: 124 (4,88) Lower I.D.: 16,5 (0,65)</p>
<p>CH08-11288</p> <p>Donaldson XLP18-2059 (For Inner Air Use ST08-11316)</p>  <p>Overall Height: 383 (15,08)</p> <p>Upper O.D.: 199 (7,83) Lower O.D.: 155 (6,10)</p> <p>Upper I.D.: 88 (3,46) Lower I.D.: 19 (0,75)</p>	<p>CH12-11343</p> <p>Donaldson P77-1527</p>  <p>Overall Height: 330 (12,99)</p> <p>Upper O.D.: 234 (9,21) Lower O.D.: 275 (10,83)</p> <p>Upper I.D.: 124 (4,88) Lower I.D.: 14 (0,55)</p>	<p>ST12-11390</p> <p>Sofiftra 1252-01 (For Outer Air Use CH12-11388)</p>  <p>Overall Height: 331 (13,03)</p> <p>Upper O.D.: 140 (5,51) Lower O.D.: 110 (4,33)</p> <p>Upper I.D.: 70 (2,76) Lower I.D.: 19,2 (0,76)</p>
<p>CH06-11295</p> <p>Massey-Ferguson 1428739-M91; (For Inner Air Use ST06-11315)</p>  <p>Overall Height: 383 (15,08)</p> <p>Upper O.D.: 162 (6,38) Lower O.D.: 134 (5,28)</p> <p>Upper I.D.: 92,5 (3,64) Lower I.D.: 19 (0,75)</p>	<p>CH-11348</p> <p>Fiat 4055745;</p>  <p>Overall Height: 68 (2,68)</p> <p>Upper O.D.: 140 (5,51) Upper I.D.: 94 (3,70)</p>	<p>SC12-11391</p> <p>Fiat-Allis 70662609; John Deere AR46004; (For Outer Air Use CH12-11389)</p>  <p>Overall Height: 330 (12,99)</p> <p>Upper O.D.: 145 (5,71) Lower O.D.: 117 (4,61)</p> <p>Upper I.D.: 88 (3,46) Lower I.D.: 17 (0,67)</p>

PRODUCT GUIDE

L'altezza non include la guarnizione/ Height not include gasket
 O.D. = diam. est. I.D. = diam. int.; Upper = Superiore ; Lower = Inferiore
 * = Cartuccia in rete metallica / Metallic net element
 ◇ = Cartuccia con termini di consegna a richiesta / Element with lead time to agree



<p>CH-11463</p>  <p>Overall Height: 71 (2,80) Upper O.D.: 140 (5,51) Upper I.D.: 94 (3,70)</p>	<p>CH-11603</p>  <p>Overall Height: 100 (3,94) Upper O.D.: 120 (4,72) Upper I.D.: M6 Lower I.D.: 70 (2,76)</p>	<p>ST05-11655 Antonio Carraro</p>  <p>Overall Height: 340 (13,39) Upper O.D.: 66 (2,60) Lower O.D.: 62 (2,44) Upper I.D.: 48 (1,89) Lower I.D.: 8,5 (0,33)</p>
<p>CH05-11467 Donaldson P12-0281, (For Inner Air Use ST-13410)</p>  <p>Overall Height: 355 (13,98) Upper O.D.: 131 (5,16) Lower O.D.: 104 (4,09) Upper I.D.: 63 (2,48) Lower I.D.: 18 (0,71)</p>	<p>ST05-11618 Fai - Fki 848101116 (For Outer Air Use CH05-11555)</p>  <p>Overall Height: 134 (5,28) Upper O.D.: 62 (2,44) Upper I.D.: 52 (2,05) Lower I.D.: 8,5 (0,33)</p>	<p>CH04-11675 Allis-Chalmers 7024760</p>  <p>Overall Height: 175 (6,89) Upper O.D.: 109,5 (4,31) Lower O.D.: 83 (3,27) Upper I.D.: 46 (1,81) Lower I.D.: 10 (0,39)</p>
<p>CH-11496 Piovan 6151210; (Replaced By 13573)</p>  <p>Overall Height: 340 (13,39) Upper O.D.: 164 (6,46) Upper I.D.: 86 (3,39) Lower I.D.: 8,5 (0,33)</p>	<p>CH-11621</p>  <p>Overall Height: 340 (13,39) Upper O.D.: 170 (6,69) Upper I.D.: 91,5 (3,60) Lower I.D.: 8 (0,31)</p>	<p>CH-11702 RCM; Gutbroad 09218016 (Polyester vertion 11702-02 Gutbroad 09213719)</p>  <p>Overall Height: 360 (14,17) Upper O.D.: 190 (7,48) Upper I.D.: 116 (4,57)</p>
<p>CH-11513 ◇ Special</p>  <p>Overall Height: 215 (8,46) Upper O.D.: 140 (5,51) Upper I.D.: 94 (3,70)</p>	<p>CH-11622</p>  <p>Overall Height: 95 (3,74) Upper O.D.: 183 (7,20) Upper I.D.: 106 (4,17) Lower I.D.: 9,5 (0,37)</p>	<p>CH-11712 Franco Perini</p>  <p>Overall Height: 217 (8,54) Upper O.D.: 234 (9,21) Upper I.D.: 124 (4,88) Lower I.D.: 15 (0,59)</p>
<p>CH05-11555 Fai - Fki 848101113; Donaldson E50-0667 (For Inner Air Use ST05-11618)</p>  <p>Overall Height: 145 (5,71) Upper O.D.: 131 (5,16) Lower O.D.: 104 (4,09) Upper I.D.: 63 (2,48) Lower I.D.: 18 (0,71)</p>	<p>CH-11623</p>  <p>Overall Height: 202 (7,95) Upper O.D.: 170 (6,69) Upper I.D.: 91,5 (3,60) Lower I.D.: 8 (0,31)</p>	<p>CH-11716</p>  <p>Overall Height: 100 (3,94) Upper O.D.: 120 (4,72) Upper I.D.: 65 (2,56) Lower I.D.: 6,5 (0,26)</p>
<p>CH-11590 Special</p>  <p>Overall Height: 304 (11,97) Upper O.D.: 197 (7,76) Lower O.D.: 155 (6,10) Upper I.D.: 88 (3,46) Lower I.D.: 19 (0,75)</p>	<p>CH-11649 ◇ For Compressors</p>  <p>Overall Height: 52 (2,05) Upper O.D.: 89 (3,50) Upper I.D.: 64 (2,52)</p>	<p>CH08-11730 8" Very Short</p>  <p>Overall Height: 150 (5,91) Upper O.D.: 197 (7,76) Lower O.D.: 155 (6,10) Upper I.D.: 88 (3,46) Lower I.D.: 19 (0,75)</p>

PRODUCT GUIDE

L'altezza non include la guarnizione/ Height not include gasket
 O.D. = diam. est. I.D. = diam. int.; Upper = Superiore ; Lower = Inferiore
 * = Cartuccia in rete metallica / Metallic net element
 ◇ = Cartuccia con termini di consegna a richiesta / Element with lead time to agree











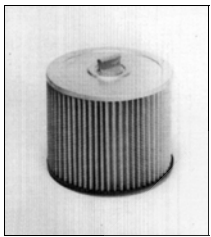



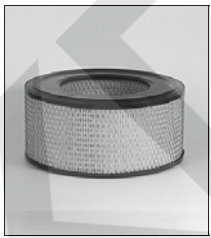

<p>CH-11731</p>  <p>Overall Height: 200 (7,87) Upper O.D.: 183 (7,20) Upper I.D.: M6 Lower I.D.: 120 (4,72)</p>	<p>CH-11758 *</p>  <p>Overall Height: 94 (3,70) Upper O.D.: 120 (4,72) Upper I.D.: 80 (3,15) Lower I.D.: 6,5 (0,26)</p>	<p>CH08-11837 Daihatsu 17801-87601</p>  <p>Overall Height: 150 (5,91) Upper O.D.: 155 (6,10) Upper I.D.: 88 (3,46) Lower I.D.: 19 (0,75)</p>
<p>CH-11732 *</p>  <p>Overall Height: 402 (15,83) Upper O.D.: 234 (9,21) Upper I.D.: 133 (5,24) Lower I.D.: 16,5 (0,65)</p>	<p>CH-11761 *</p>  <p>Overall Height: 56 (2,20) Upper O.D.: 134 (5,28) Upper I.D.: 92,5 (3,64)</p>	<p>CH06-11880 Massey Ferguson 3310358M1 (For Inner Air Use ST06-12048)</p>  <p>Overall Height: 289 (11,38) Upper O.D.: 162 (6,38) Lower O.D.: 138 (5,43) Upper I.D.: 7/16 UNF-20 Lower I.D.: 72 (2,83)</p>
<p>CH-11738 ◇ (Replaced By CH-13577)</p>  <p>Overall Height: 400 (15,75) Upper O.D.: 234 (9,21) Upper I.D.: 124 (4,88) Lower I.D.: 16,5 (0,65)</p>	<p>CH-11764</p>  <p>Overall Height: 788 (31,02) Upper O.D.: 392 (15,43) Upper I.D.: 302 (11,89) Lower I.D.: 14 (0,55)</p>	<p>CH-11929</p>  <p>Overall Height: 145 (5,71) Upper O.D.: 120 (4,72) Upper I.D.: 70 (2,76) Lower I.D.: 6,5 (0,26)</p>
<p>CH-11749</p>  <p>Overall Height: 284 (11,18) Upper O.D.: 120 (4,72) Upper I.D.: 70 (2,76) Lower I.D.: 6,5 (0,26)</p>	<p>CH-11789 Mercedes-Benz 30943904; Mann C15127/1</p>  <p>Overall Height: 218 (8,58) Upper O.D.: 150 (5,91) Upper I.D.: 72 (2,83) Lower I.D.: 11 (0,43)</p>	<p>CH08-11935 Poclain TI950555 (For Inner Air Use ST08-11316)</p>  <p>Overall Height: 382 (15,02) Upper O.D.: 214 (8,43) Lower O.D.: 195 (7,68) Upper I.D.: 7/16 UNF-20 Lower I.D.: 88 (3,46)</p>
<p>CH-11752 *</p>  <p>Overall Height: 202 (7,95) Upper O.D.: 164 (6,46) Upper I.D.: 86 (3,39) Lower I.D.: 9 (0,35)</p>	<p>CH-11808 Motoscope</p>  <p>Overall Height: 360 (14,17) Upper O.D.: 190 (7,48) Upper I.D.: 130 (5,12) Lower I.D.: 11 (0,43)</p>	<p>CH-11940 Impianti di verniciatura / Painting plants</p>  <p>Overall Height: 600 (23,62) Upper O.D.: 324 (12,76) Upper I.D.: 214 (8,43) Lower I.D.: 13 (0,51)</p>
<p>CH-11755 *</p>  <p>Overall Height: 332 (13,07) Upper O.D.: 164 (6,46) Upper I.D.: 86 (3,39) Lower I.D.: 9 (0,35)</p>	<p>CH-11811 ◇ Motoscope</p>  <p>Overall Height: 360 (14,17) Upper O.D.: 190 (7,48) Upper I.D.: 116 (4,57) Lower I.D.: 118 (4,65)</p>	<p>CH06-11941 J.C.B 32206002</p>  <p>Overall Height: 344 (13,54) Upper O.D.: 170 (6,69) Lower O.D.: 137 (5,39) Upper I.D.: M10 x 1,5 Lower I.D.: 72 (2,83)</p>

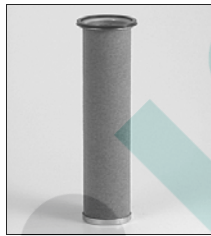
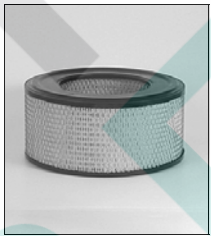
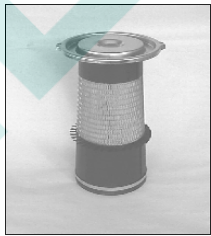
PRODUCT GUIDE

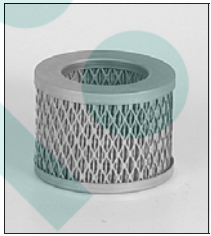
L'altezza non include la guarnizione/ Height not include gasket
 O.D. = diam. est. I.D. = diam. int.; Upper = Superiore ; Lower = Inferiore
 * = Cartuccia in rete metallica / Metallic net element
 ◇ = Cartuccia con termini di consegna a richiesta / Element with lead time to agree





















CH08-11942  John Deere DDX-18911 Overall Height: 378 (14,88) Upper O.D.: 213 (8,39) Lower O.D.: 197 (7,76) Upper I.D.: 7/16 UNF-20 Lower I.D.: 87 (3,43)	CH-12105 ◇  Special Overall Height: 136 (5,35) Upper O.D.: 176 (6,93) Lower I.D.: 144 (5,67)	CH05-12202  Iseki 1480-104-2070-0 Overall Height: 190 (7,48) Upper O.D.: 130 (5,12) Lower O.D.: 104 (4,09) Upper I.D.: 63 (2,48) Lower I.D.: 19 (0,75)
CH-11958  Parise Overall Height: 79 (3,11) Upper O.D.: 140 (5,51) Upper I.D.: 94 (3,70)	ST-12106  Inner Air of CH08-11998 Overall Height: 186 (7,32) Upper O.D.: 106 (4,17) Lower O.D.: 85 (3,35) Upper I.D.: 74 (2,91) Lower I.D.: 10,2 (0,40)	CH-12203  Fiat 8822160, 8322160, 4975549, 4971958 Overall Height: 406 (15,98) Upper O.D.: 236 (9,29) Upper I.D.: 124 (4,88) Lower I.D.: 12 (0,47)
CH08-11998  For Inner Air Use ST-12106 Overall Height: 225 (8,86) Upper O.D.: 197 (7,76) Lower O.D.: 155 (6,10) Upper I.D.: 88 (3,46) Lower I.D.: 19 (0,75)	CH-12135  Alfa Romeo 701009/E; Goldoni 27516 Overall Height: 64 (2,52) Upper O.D.: 210 (8,27) Upper I.D.: 165 (6,50)	CH-12204 ◇  Fiat 4972550 Overall Height: 397 (15,61) Upper O.D.: 125 (4,92) Upper I.D.: 86 (3,39) Lower I.D.: 9 (0,35)
ST06-12048  Massey Ferguson 3310355M1; Donaldson P77-0181 (For Outer Air Use CH06-11880) Overall Height: 251 (9,88) Upper O.D.: 92,5 (3,64) Lower O.D.: 70 (2,76) Upper I.D.: 62 (2,44) Lower I.D.: 17 (0,67)	CH-12150  Ruggnerini; Renault 4 Overall Height: 66 (2,60) Upper O.D.: 168 (6,61) Upper I.D.: 108 (4,25)	CH-12205  Same 2.4249.250.1 Overall Height: 316 (12,44) Upper O.D.: 162 (6,38) Lower O.D.: 149 (5,87) Lower I.D.: 80,5 (3,17)
CH-12091  Deutz 2311565, 2339813; Mann C17134; (For Inner Air use ST-14758) Overall Height: 200 (7,87) Upper O.D.: 164 (6,46) Upper I.D.: 86 (3,39)	CH-12177  Rolls Royce UE9813 Overall Height: 96 (3,78) Upper O.D.: 210 (8,27) Upper I.D.: 149,4 (5,88)	CH-12206 ◇  Petter JF35/6; Atlas Copco 1619-1269 Overall Height: 123 (4,84) Upper O.D.: 138 (5,43) Upper I.D.: 81 (3,19)
CH-12093  Volvo 1661667 Overall Height: 656 (25,83) Upper O.D.: 335 (13,19) Lower O.D.: 280 (11,02) Lower I.D.: 182 (7,17)	CH-12181  Komatsu 600-181-7360; Mitsubishi 91461-11400 Overall Height: 240 (9,45) Upper O.D.: 83 (3,27) Upper I.D.: 54 (2,13) Lower I.D.: 16,5 (0,65)	CH-12207 ◇  Caterpillar 4M-9378; (For Inner Air U9378Caterpillar 4M-8047; Donaldson P18- 1103; (For Inner Air Use CH-13157) Overall Height: 254 (10,00) Upper O.D.: 213 (8,39) Upper I.D.: 103 (4,06)

PRODUCT GUIDE

L'altezza non include la guarnizione/ Height not include gasket
 O.D. = diam. est. I.D. = diam. int.; Upper = Superiore ; Lower = Inferiore
 * = Cartuccia in rete metallica / Metallic net element
 ◇ = Cartuccia con termini di consegna a richiesta / Element with lead time to agree













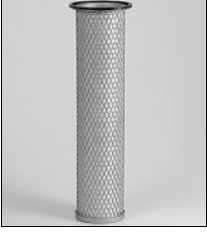



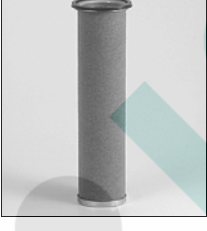

<p>CH-12208</p>  <p>Caterpillar 4M-8047; (For Inner Air Use CH-13157)</p> <p>Overall Height: 305 (11,99) Upper O.D.: 234 (9,21) Upper I.D.: 123 (4,84)</p>	<p>CH-12214</p>  <p>Caterpillar 4M-9334; (For Inner Air Use CH-13156 Or CH-13141)</p> <p>Overall Height: 330 (12,99) Upper O.D.: 281,7 (11,09) Upper I.D.: 170,3 (6,70)</p>	<p>CH-12220 ◇</p>  <p>Same 2.4249.090.1</p> <p>Overall Height: 200 (7,87) Upper O.D.: 168 (6,61) Upper I.D.: 100 (3,94)</p>
<p>CH-12209 ◇</p>  <p>Fiat-Allis 7237395;</p> <p>Overall Height: 263 (10,35) Upper O.D.: 114 (4,49) Upper I.D.: 56 (2,20)</p>	<p>CH-12215 ◇</p>  <p>Fiat Allis 8322121</p> <p>Overall Height: 163 (6,42) Upper O.D.: 136 (5,35) Upper I.D.: 102 (4,02)</p>	<p>CH08-12221</p>  <p>John Deere AR39798; Same 2.4249.110.1</p> <p>Overall Height: 254 (10,00) Upper O.D.: 197 (7,76) Lower O.D.: 155 (6,10) Upper I.D.: 88 (3,46) Lower I.D.: 19 (0,75)</p>
<p>CH-12210</p>  <p>Caterpillar 7M-9045; (For Inner Air Use CH-13150)</p> <p>Overall Height: 406 (15,98) Upper O.D.: 281,7 (11,09) Upper I.D.: 170,5 (6,71)</p>	<p>CH-12216 ◇</p>  <p>Fiat Allis 8322122</p> <p>Overall Height: 195 (7,68) Upper O.D.: 222 (8,74) Upper I.D.: 154 (6,06)</p>	<p>CH05-12222</p>  <p>Same 2.4249.050.1 ; Donaldson P10-8736 (For Inner Air Use ST05-14980)</p> <p>Overall Height: 228 (8,98) Upper O.D.: 132 (5,20) Lower O.D.: 104 (4,09) Upper I.D.: 63 (2,48) Lower I.D.: 19 (0,75)</p>
<p>CH-12211 ◇</p>  <p>Goldoni</p> <p>Overall Height: 200 (7,87) Upper O.D.: 88 (3,46) Upper I.D.: 50 (1,97)</p>	<p>CH-12217 ◇</p>  <p>Fiat 8322211</p> <p>Overall Height: 316 (12,44) Upper O.D.: 162 (6,38) Upper I.D.: 103 (4,06) Lower I.D.: 9 (0,35)</p>	<p>ST-12223 ◇</p>  <p>Same 2.4249.120.1</p> <p>Overall Height: 230 (9,06) Upper O.D.: 94 (3,70) Lower O.D.: 75 (2,95) Upper I.D.: 85 (3,35) Lower I.D.: 17 (0,67)</p>
<p>CH-12212 ◇</p>  <p>Atlas-Copco 16191613</p> <p>Overall Height: 265 (10,43) Upper O.D.: 160 (6,30) Upper I.D.: 99 (3,90)</p>	<p>CH-12218 ◇</p>  <p>Fiat 8322212</p> <p>Overall Height: 288 (11,34) Upper O.D.: 100 (3,94) Upper I.D.: 76 (2,99) Lower I.D.: 9 (0,35)</p>	<p>CH10-12224 ◇</p>  <p>Cummins 158876; Donaldson XLP18-2045</p> <p>Overall Height: 256 (10,08) Upper O.D.: 251 (9,88) Lower O.D.: 202 (7,95) Upper I.D.: 91 (3,58) Lower I.D.: 13,5 (0,53)</p>
<p>CH-12213 ◇</p>  <p>Volvo 347436</p> <p>Overall Height: 254 (10,00) Upper O.D.: 215 (8,46) Upper I.D.: 151 (5,94) Lower I.D.: 9,5 (0,37)</p>	<p>CH-12219 ◇</p>  <p>Komatsu 6112-83-7620</p> <p>Overall Height: 316 (12,44) Upper O.D.: 163,5 (6,44) Lower O.D.: 190 (7,48) Upper I.D.: 103 (4,06)</p>	<p>CH-12225</p>  <p>Deutz 2339823; Mann C17250</p> <p>Overall Height: 321 (12,64) Upper O.D.: 164 (6,46) Upper I.D.: 86 (3,39)</p>

PRODUCT GUIDE





















L'altezza non include la guarnizione/ Height not include gasket
 O.D. = diam. est. I.D. = diam. int.; Upper = Superiore ; Lower = Inferiore
 * = Cartuccia in rete metallica / Metallic net element
 ◇ = Cartuccia con termini di consegna a richiesta / Element with lead time to agree

<p>ST-12226</p>  <p>Case International 537335R1; (For Outer Air Use CH06-11056)</p> <p>Overall Height: 280 (11,02)</p> <p>Upper O.D.: 92,5 (3,64) Lower O.D.: 75 (2,95)</p> <p>Upper I.D.: 62 (2,44) Lower I.D.: 17 (0,67)</p>	<p>CH-12232 ◇</p>  <p>Mann C20325; Deutz 2241034</p> <p>Overall Height: 365 (14,37)</p> <p>Upper O.D.: 198 (7,80) Lower O.D.: 247 (9,72)</p> <p>Upper I.D.: 103 (4,06) Lower I.D.: 8,5 (0,33)</p>	<p>CH-12239</p>  <p>Mann C24355</p> <p>Overall Height: 217 (8,54)</p> <p>Upper O.D.: 242 (9,53)</p> <p>Upper I.D.: 132 (5,20)</p>
<p>ST-12227 ◇</p>  <p>Case International 627935- C1;</p> <p>Overall Height: 303 (11,93)</p> <p>Upper O.D.: 162 (6,38) Lower O.D.: 133 (5,24)</p> <p>Upper I.D.: 92 (3,62) Lower I.D.: 19 (0,75)</p>	<p>CH-12233 ◇</p>  <p>Volvo 460406</p> <p>Overall Height: 85 (3,35)</p> <p>Upper O.D.: 170 (6,69)</p> <p>Upper I.D.: 116 (4,57)</p>	<p>CH-12240 ◇</p>  <p>Massey-Ferguson 1435408-M92</p> <p>Overall Height: 354 (13,94)</p> <p>Upper O.D.: 113,5 (4,47) Lower O.D.: 128 (5,04)</p> <p>Upper I.D.: 57 (2,24)</p>
<p>CH08-12228</p>  <p>Donaldson P12-4164; (For Inner Air Use ST08-12229)</p> <p>Overall Height: 328 (12,91)</p> <p>Upper O.D.: 199,5 (7,85) Lower O.D.: 155 (6,10)</p> <p>Upper I.D.: 88 (3,46) Lower I.D.: 17 (0,67)</p>	<p>CH-12234</p>  <p>M.A.N. 81083040024; Mann C23500</p> <p>Overall Height: 369 (14,53)</p> <p>Upper O.D.: 227 (8,94)</p> <p>Upper I.D.: 117 (4,61)</p>	<p>CH-12241</p>  <p>Massey-Ferguson 1806088-M91;</p> <p>Overall Height: 268 (10,55)</p> <p>Upper O.D.: 113,5 (4,47) Lower O.D.: 128 (5,04)</p> <p>Upper I.D.: 57 (2,24)</p>
<p>ST08-12229</p>  <p>Donaldson P12-7787; (For Outer Air Use CH08- 12228)</p> <p>Overall Height: 305 (12,01)</p> <p>Upper O.D.: 105 (4,13) Lower O.D.: 85 (3,35)</p> <p>Upper I.D.: 74 (2,91) Lower I.D.: 17 (0,67)</p>	<p>CH-12235</p>  <p>Scania 219517; DAF 607179; (For Inner Air Use CH-13529)</p> <p>Overall Height: 484 (19,06)</p> <p>Upper O.D.: 242 (9,53)</p> <p>Upper I.D.: 132 (5,20) Lower I.D.: 11 (0,43)</p>	<p>CH-12242</p>  <p>Mercedes-Benz 10944704 (For Inner Air Use ST- 13527)</p> <p>Overall Height: 369 (14,53)</p> <p>Upper O.D.: 227 (8,94)</p> <p>Upper I.D.: 117 (4,61) Lower I.D.: 10,5 (0,41)</p>
<p>CH-12230</p>  <p>Mann C13114/4; Donaldson P14-0131</p> <p>Overall Height: 284 (11,18)</p> <p>Upper O.D.: 126 (4,96)</p> <p>Upper I.D.: 65 (2,56) Lower I.D.: 8,5 (0,33)</p>	<p>CH-12236 ◇</p>  <p>Mercedes Benz 10949404</p> <p>Overall Height: 484 (19,06)</p> <p>Upper O.D.: 210 (8,27) Lower O.D.: 253 (9,96)</p> <p>Upper I.D.: 103 (4,06) Lower I.D.: 10 (0,39)</p>	<p>CH08-12243</p>  <p>Clark 888936; Donaldson P11-8675;</p> <p>Overall Height: 306 (12,05)</p> <p>Upper O.D.: 197 (7,76) Lower O.D.: 155 (6,10)</p> <p>Upper I.D.: 88 (3,46)</p>
<p>CH-12231</p>  <p>Mann C151653</p> <p>Overall Height: 325 (12,80)</p> <p>Upper O.D.: 150 (5,91)</p> <p>Upper I.D.: 71 (2,80) Lower I.D.: 9 (0,35)</p>	<p>CH-12238</p>  <p>M.A.N. 81083040039; Mann C24700/1</p> <p>Overall Height: 484 (19,06)</p> <p>Upper O.D.: 242 (9,53)</p> <p>Upper I.D.: 132 (5,20)</p>	<p>CH09-12244</p>  <p>Mann C18436; Donaldson P18-1063; P18-2063; (For Inner Air Use ST09-12265)</p> <p>Overall Height: 406 (15,98)</p> <p>Upper O.D.: 224 (8,82) Lower O.D.: 174 (6,85)</p> <p>Upper I.D.: 107 (4,21) Lower I.D.: 17 (0,67)</p>

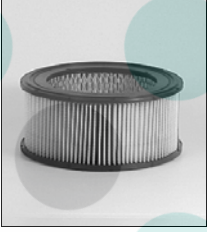
PRODUCT GUIDE

L'altezza non include la guarnizione/ Height not include gasket
 O.D. = diam. est. I.D. = diam. int.; Upper = Superiore ; Lower = Inferiore
 * = Cartuccia in rete metallica / Metallic net element
 ◇ = Cartuccia con termini di consegna a richiesta / Element with lead time to agree



<p>CH14-12245</p>  <p>Donaldson XLP18-2046; (For Inner Air Use SC-12254)</p> <p>Overall Height: 408 (16,06) Upper O.D.: 282 (11,10) Upper I.D.: 171 (6,73) Lower I.D.: 17 (0,67)</p>	<p>CH12-12251</p>  <p>Cummins 158877; Atlas-Copco 16191879</p> <p>Overall Height: 254 (10,00) Upper O.D.: 296 (11,65) Lower O.D.: 234,5 (9,23) Upper I.D.: 122,5 (4,82) Lower I.D.: 17 (0,67)</p>	<p>CH06-12258 ◇</p>  <p>JCB 32/203702;</p> <p>Overall Height: 305 (12,00) Upper O.D.: 163 (6,42) Lower O.D.: 133,5 (5,26) Upper I.D.: 70,5 (2,78) Lower I.D.: 19 (0,75)</p>
<p>CH-12246 ◇</p>  <p>Mercedes Benz 10949304; Mann C28715</p> <p>Overall Height: 244 (9,61) Upper O.D.: 276 (10,87) Lower O.D.: 333 (13,11) Upper I.D.: 133 (5,24) Lower I.D.: 11 (0,43)</p>	<p>SC-12252</p>  <p>Donaldson P11-9372; (For Outer Air Use CH-12253)</p> <p>Overall Height: 450 (17,72) Upper O.D.: 217 (8,54) Lower O.D.: 185 (7,28) Upper I.D.: 157 (6,18) Lower I.D.: 17 (0,67)</p>	<p>CH-12260 ◇</p>  <p>Donaldson P11-7808; P11-9238; XLP18-2036</p> <p>Overall Height: 407 (16,00) Upper O.D.: 352 (13,86) Upper I.D.: 240,5 (9,47) Lower I.D.: 17 (0,67)</p>
<p>CH-12247 ◇</p>  <p>Mercedes Benz 10948304; Mann C33922</p> <p>Overall Height: 244 (9,61) Upper O.D.: 327 (12,87) Lower O.D.: 383 (15,08) Upper I.D.: 167 (6,57) Lower I.D.: 11 (0,43)</p>	<p>CH16-12253</p>  <p>Overall Height: 456 (17,95) Upper O.D.: 308 (12,13) Upper I.D.: 195 (7,68) Lower I.D.: 17 (0,67)</p>	<p>CH-12262 ◇</p>  <p>Cummins 150749; 299354; Donaldson P18-1033</p> <p>Overall Height: 229 (9,00) Upper O.D.: 264,4 (10,41) Upper I.D.: 153 (6,02) Lower I.D.: 17 (0,67)</p>
<p>CH-12248</p>  <p>Mann C234402;</p> <p>Overall Height: 285 (11,22) Upper O.D.: 227 (8,94) Upper I.D.: 117 (4,61) Lower I.D.: 10,5 (0,41)</p>	<p>SC14-12254</p>  <p>John Deere U44956; (For Outer Air Use CH-12245)</p> <p>Overall Height: 406 (15,98) Upper O.D.: 195 (7,68) Lower O.D.: 162,5 (6,40) Upper I.D.: 134 (5,28) Lower I.D.: 17 (0,67)</p>	<p>CH-12263 ◇</p>  <p>Universal Filter 27.971.00</p> <p>Overall Height: 379 (14,92) Upper O.D.: 169 (6,65) Lower O.D.: 190 (7,48) Upper I.D.: 95 (3,74) Lower I.D.: 11 (0,43)</p>
<p>CH-12249 ◇</p>  <p>Atlas-Copco 10300832</p> <p>Overall Height: 110 (4,33) Upper O.D.: 301,5 (11,87) Upper I.D.: 190,5 (7,50)</p>	<p>CH-12255 ◇</p>  <p>Massey Ferguson 1698679M1</p> <p>Overall Height: 312 (12,26) Upper O.D.: 132 (5,20) Upper I.D.: 76 (2,99) Filettato</p>	<p>CH-12264 ◇</p>  <p>Scania 261185</p> <p>Overall Height: 460 (18,11) Upper O.D.: 301,9 (11,89) Lower O.D.: 376 (14,80) Upper I.D.: 167 (6,57) Lower I.D.: 11 (0,43)</p>
<p>CH-12250 ◇</p>  <p>Volvo 475230</p> <p>Overall Height: 208 (8,19) Upper O.D.: 333,7 (13,14) Upper I.D.: 204 (8,03)</p>	<p>CH-12257 ◇</p>  <p>John Deere AR-51923</p> <p>Overall Height: 280 (11,02) Upper O.D.: 116 (4,57) Upper I.D.: 88 (3,46) Lower I.D.: 17 (0,67)</p>	<p>ST09-12265</p>  <p>Allis-Chalmers 70267953 ; Donaldson P11-9778 ; (For Outer Air Use CH09-12244 Or CH-12286)</p> <p>Overall Height: 381 (15,00) Upper O.D.: 123 (4,84) Lower O.D.: 104 (4,09) Upper I.D.: 93 (3,66) Lower I.D.: 17,5 (0,69)</p>

















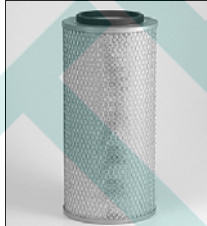

PRODUCT GUIDE



L'altezza non include la guarnizione/ Height not include gasket
 O.D. = diam. est. I.D. = diam. int.; Upper = Superiore ; Lower = Inferiore

* = Cartuccia in rete metallica / Metallic net element

◇ = Cartuccia con termini di consegna a richiesta / Element with lead time to agree

<p>CH-12266 ◇ Donaldson P11-7441; Massey-Ferguson 1097001-M91; Coopers AZA509</p>  <p>Overall Height: 457 (18,00) Upper O.D.: 352 (13,86) Upper I.D.: 240 (9,45) Lower I.D.: 23 (0,91)</p>	<p>CH-12273 Euclid 9035429; Donaldson P18-1041; (For Inner Air Use CH-12274)</p>  <p>Overall Height: 407 (16,00) Upper O.D.: 307 (12,09) Upper I.D.: 196 (7,72) Lower I.D.: 23 (0,91)</p>	<p>CH-12279 Renault 7701027437; (For Outer Air Use CH-12500)</p>  <p>Overall Height: 336 (13,23) Upper O.D.: 132 (5,20) Upper I.D.: 103 (4,06) Lower I.D.: 8,5 (0,33)</p>
<p>CH-12268 ◇ Donaldson Hsg 3830577S; Donaldson P18-1007</p>  <p>Overall Height: 555 (21,85) Upper O.D.: 264 (10,39) Upper I.D.: 153 (6,02)</p>	<p>SC-12274 ◇ Donaldson P11-9370 ; IHC 702753-C1 ; (For Outer Air Use CH-12273)</p>  <p>Overall Height: 381 (15,00) Upper O.D.: 194 (7,64) Upper I.D.: 153,5 (6,04) Lower I.D.: 22 (0,87)</p>	<p>CH-12282 ◇ Donaldson P11-9297; Renault 3564135</p>  <p>Overall Height: 508 (20,00) Upper O.D.: 324 (12,76) Upper I.D.: 211 (8,31)</p>
<p>CH-12269 Donaldson XLP18-1044; P10-9200; P11-7433</p>  <p>Overall Height: 355 (13,98) Upper O.D.: 264 (10,39) Upper I.D.: 153 (6,02) Lower I.D.: 23 (0,91)</p>	<p>CH-12275 ◇ John Deere AT-33363, AR-39799</p>  <p>Overall Height: 253 (9,96) Upper O.D.: 224 (8,82) Lower O.D.: 174 (6,85) Upper I.D.: 107 (4,21) Lower I.D.: 17 (0,67)</p>	<p>CH-12283 Volvo 1660619; (For Inner Air Use CH-12302)</p>  <p>Overall Height: 356 (14,00) Upper O.D.: 310 (12,20) Upper I.D.: 200 (7,87) Lower I.D.: 17 (0,67)</p>
<p>SC-12270 ◇ Donaldson P11-9371 ; Ingersoll-Rand 56778459 ; (For Outer Air Use CH-12269)</p>  <p>Overall Height: 303 (11,93) Upper O.D.: 151 (5,94) Upper I.D.: 122 (4,80) Lower I.D.: 22 (0,87)</p>	<p>CH-12276 Poclain V0450543; Massey Ferguson 3074305-M1</p>  <p>Overall Height: 404 (15,91) Upper O.D.: 234 (9,21) Upper I.D.: 122 (4,80) Lower I.D.: 17 (0,67)</p>	<p>CH-12284 Donaldson P11-1065</p>  <p>Overall Height: 355 (13,98) Upper O.D.: 280 (11,02) Upper I.D.: 172 (6,77) Lower I.D.: 17 (0,67)</p>
<p>CH-12271 ◇ Donaldson P15-8671; Caterpillar 4N-313 (For Outer Air Use CH-12271)</p>  <p>Overall Height: 307 (12,07) Upper O.D.: 174 (6,85) Upper I.D.: 88 (3,46) Lower I.D.: 17,5 (0,69)</p>	<p>CH-12277 ◇ Iveco 1901780</p>  <p>Overall Height: 404 (15,91) Upper O.D.: 265 (10,43) Upper I.D.: 163 (6,42)</p>	<p>CH-12285 Fendt F278201090020</p>  <p>Overall Height: 226 (8,90) Upper O.D.: 165 (6,50) Upper I.D.: 86,5 (3,41)</p>
<p>CH-12272 ◇ Donaldson P15-8671; Caterpillar 4N-313 (For Outer Air Use CH-12271)</p>  <p>Overall Height: 256 (10,08) Upper O.D.: 86 (3,39) Upper I.D.: 56 (2,20) Lower I.D.: 17 (0,67)</p>	<p>CH-12278 M.A.N. 81083040044 (For Inner Air Use CH-13528)</p>  <p>Overall Height: 460 (18,11) Upper O.D.: 302 (11,89) Upper I.D.: 191 (7,52) Lower I.D.: 11 (0,43)</p>	<p>CH-12286 ◇ Leibherr 7401179</p>  <p>Overall Height: 406 (15,98) Upper O.D.: 194 (7,64) Upper I.D.: 109 (4,29) Lower I.D.: 17 (0,67)</p>

PRODUCT GUIDE



L'altezza non include la guarnizione/ Height not include gasket
 O.D. = diam. est. I.D. = diam. int.; Upper = Superiore ; Lower = Inferiore
 * = Cartuccia in rete metallica / Metallic net element
 ◇ = Cartuccia con termini di consegna a richiesta / Element with lead time to agree

<p>CH-12287 Mann C13135</p>  <p>Overall Height: 225 (8,86) Upper O.D.: 126 (4,96) Upper I.D.: 65 (2,56)</p>	<p>CH-12345 Benfra 40199 ;Donaldson P77-2531</p>  <p>Overall Height: 404 (15,91) Upper O.D.: 317,5 (12,50) Lower O.D.: 264 (10,39) Upper I.D.: 7/16 UNF-20 Lower I.D.: 153 (6,02)</p>	<p>CH-12397 Mann & Hummel C11763</p>  <p>Overall Height: 217 (8,54) Upper O.D.: 109 (4,29) Upper I.D.: 52 (2,05) Lower I.D.: 8,5 (0,33)</p>
<p>CH-12288 ◇ Fiat 61583385</p>  <p>Overall Height: 290 (11,42) Upper O.D.: 226 (8,90) Upper I.D.: 117 (4,61) Lower I.D.: 11 (0,43)</p>	<p>CH-12385 Mann C20325/2 ; Scania 218989 (For Inner Air Use ST-13531)</p>  <p>Overall Height: 362 (14,25) Upper O.D.: 198 (7,80) Upper I.D.: 104 (4,09) Lower I.D.: 8,5 (0,33)</p>	<p>CH-12403 Caterpillar 8N-6309</p>  <p>Overall Height: 250 (9,84) Upper O.D.: 485 (19,09) Upper I.D.: 335 (13,19)</p>
<p>CH-12289 ◇ Volvo 475975</p>  <p>Overall Height: 604 (23,78) Upper O.D.: 200 (7,87) Upper I.D.: 115 (4,53) Lower I.D.: 11 (0,43)</p>	<p>CH-12386 Mann C17225/3; Deutz 2165044; Atlas Copco 1619.1269; (For Inner Air Use ST-13530)</p>  <p>Overall Height: 340 (13,39) Upper O.D.: 164 (6,46) Upper I.D.: 86 (3,39) Lower I.D.: 9 (0,35)</p>	<p>CH-12405</p>  <p>Overall Height: 788 (31,02) Upper O.D.: 324 (12,76) Upper I.D.: 214 (8,43) Lower I.D.: 13 (0,51)</p>
<p>CH-12290 Same 2.4249.340.1: Donaldson P77-0619 (For Inner Air Use ST-14113)</p>  <p>Overall Height: 315 (12,40) Upper O.D.: 162 (6,38) Lower O.D.: 149 (5,87) Upper I.D.: 7/16 UNF-20 Lower I.D.: 80,5 (3,17)</p>	<p>CH-12387 Scania 395773; Mann C30703; DAF 693099;</p>  <p>Overall Height: 365 (14,37) Upper O.D.: 302 (11,89) Upper I.D.: 190,7 (7,51) Lower I.D.: 10,5 (0,41)</p>	<p>ST08-12459 Special</p>  <p>Overall Height: 188 (7,40) Upper O.D.: 85 (3,35) Upper I.D.: 72 (2,83) Lower I.D.: 10,2 (0,40)</p>
<p>CH-12291 Piovani 9517050</p>  <p>Overall Height: 95 (3,74) Upper O.D.: 120 (4,72) Upper I.D.: 70 (2,76) Lower I.D.: 9 (0,35)</p>	<p>CH10-12390 Fiatagri 71415282; Donaldson XLP77-2555</p>  <p>Overall Height: 406 (15,98) Upper O.D.: 279 (10,98) Lower O.D.: 201 (7,91) Upper I.D.: 7/16 UNF-20 Lower I.D.: 135 (5,31)</p>	<p>CH-12463 Parise Compressori</p>  <p>Overall Height: 92 (3,62) Upper O.D.: 210 (8,27) Upper I.D.: 165 (6,50)</p>
<p>CH-12302 Volvo 1544298; (For Outer Air Use CH-12283 On Volvo Application)</p>  <p>Overall Height: 314 (12,36) Upper O.D.: 197 (7,76) Upper I.D.: 176 (6,93) Lower I.D.: 10,5 (0,41)</p>	<p>SC10-12395 John Deere T46317</p>  <p>Overall Height: 380 (14,96) Upper O.D.: 117 (4,61) Upper I.D.: 88 (3,46) Lower I.D.: 17 (0,67)</p>	<p>CH-12474</p>  <p>Overall Height: 95 (3,74) Upper O.D.: 140 (5,51) Upper I.D.: 94 (3,70)</p>

















PRODUCT GUIDE

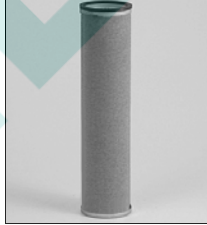

L'altezza non include la guarnizione/ Height not include gasket
 O.D. = diam. est. I.D. = diam. int.; Upper = Superiore ; Lower = Inferiore

* = Cartuccia in rete metallica / Metallic net element

◇ = Cartuccia con termini di consegna a richiesta / Element with lead time to agree

<p>CH-12485</p>  <p>Massey-Ferguson 1678295-M1; (For Outer Air Use CH-12491 Or CH- 12498 Depending on Application)</p> <p>Overall Height: 290 (11,42)</p> <p>Upper O.D.: 74 (2,91)</p> <p>Upper I.D.: 48 (1,89)</p> <p>Lower I.D.: 8,5 (0,33)</p>	<p>ST08-12576</p>  <p>Special</p> <p>Overall Height: 287 (11,30)</p> <p>Upper O.D.: 105 (4,13)</p> <p>Lower O.D.: 85 (3,35)</p> <p>Upper I.D.: 74 (2,91)</p> <p>Lower I.D.: 17 (0,67)</p>	<p>CH-12660</p>  <p>Volvo 347437; Donaldson P18-1034</p> <p>Overall Height: 269 (10,57)</p> <p>Upper O.D.: 268 (10,55)</p> <p>Upper I.D.: 195 (7,68)</p>
<p>CH-12491</p>  <p>Massey-Ferguson 1678294-M1; (For Inner Air Use CH-12485)</p> <p>Overall Height: 312 (12,28)</p> <p>Upper O.D.: 132 (5,20)</p> <p>Lower O.D.: 146 (5,75)</p> <p>Upper I.D.: 76 (2,99)</p> <p>Lower I.D.: 10 (0,39)</p>	<p>CH-12598</p>  <p>Piovan 9513540</p> <p>Overall Height: 95 (3,74)</p> <p>Upper O.D.: 183 (7,20)</p> <p>Upper I.D.: 106 (4,17)</p> <p>M6</p>	<p>CH-12667 ◇ Special</p>  <p>Overall Height: 250 (9,84)</p> <p>Upper O.D.: 485 (19,09)</p> <p>Upper I.D.: 335 (13,19)</p>
<p>CH-12498</p>  <p>Massey-Ferguson 1678308-M91; (For Inner Air Use CH-12485)</p> <p>Overall Height: 312 (12,28)</p> <p>Upper O.D.: 132 (5,20)</p> <p>Lower O.D.: 135 (5,31)</p> <p>Upper I.D.: 76 (2,99)</p> <p>Lower I.D.: 10 (0,39)</p>	<p>CH-12599 ◇ (Replaced By CH-13579)</p>  <p>Overall Height: 202 (7,95)</p> <p>Upper O.D.: 164 (6,46)</p> <p>Upper I.D.: 86 (3,39)</p> <p>Lower I.D.: 8,5 (0,33)</p>	<p>CH-12688</p>  <p>Woodgate WGA 494K</p> <p>Overall Height: 280 (11,02)</p> <p>Upper O.D.: 163 (6,42)</p> <p>Lower O.D.: 134 (5,28)</p> <p>Upper I.D.: 84 (3,31)</p> <p>Lower I.D.: 16,5 (0,65)</p>
<p>CH-12500</p>  <p>Renault 7701027436; (For Inner Air Use CH-12279)</p> <p>Overall Height: 359 (14,13)</p> <p>Upper O.D.: 211 (8,31)</p> <p>Lower O.D.: 230 (9,06)</p> <p>Upper I.D.: 135 (5,31)</p> <p>Lower I.D.: 10 (0,39)</p>	<p>CH-12604</p>  <p>Komatsu 600-181-2500; (For Inner Air Use CH- 12605)</p> <p>Overall Height: 320 (12,60)</p> <p>Upper O.D.: 248 (9,76)</p> <p>Upper I.D.: 143,5 (5,65)</p> <p>M10 x 1,5</p>	<p>ST-12689</p>  <p>Woodgate WGA 494S</p> <p>Overall Height: 260 (10,24)</p> <p>Upper O.D.: 82 (3,23)</p> <p>Upper I.D.: 64 (2,52)</p> <p>Lower I.D.: 12 (0,47)</p>
<p>CH-12507</p>  <p>Hitachi 4129907</p> <p>Overall Height: 380 (14,96)</p> <p>Upper O.D.: 186 (7,32)</p> <p>Lower O.D.: 247 (9,72)</p> <p>Upper I.D.: 119,5 (4,70)</p> <p>Lower I.D.: 16,9 (0,67)</p>	<p>CH-12605</p>  <p>Komatsu 600-181- 2461;(For Outer Air Use CH-12604)</p> <p>Overall Height: 268 (10,55)</p> <p>Upper O.D.: 140 (5,51)</p> <p>Upper I.D.: 107,5 (4,23)</p> <p>Lower I.D.: 16 (0,63)</p>	<p>CH-12694</p>  <p>Iseki 1544-104-2020-0</p> <p>Overall Height: 177 (6,97)</p> <p>Upper O.D.: 127 (5,00)</p> <p>Lower O.D.: 83 (3,27)</p> <p>Upper I.D.: 6 (0,24)</p> <p>Lower I.D.: 46 (1,81)</p>
<p>CH-12532</p>  <p>Fini 17026</p> <p>Overall Height: 92 (3,62)</p> <p>Upper O.D.: 215 (8,46)</p> <p>Upper I.D.: 146 (5,75)</p>	<p>CH-12653</p>  <p>JCB 98800031</p> <p>Overall Height: 285 (11,22)</p> <p>Upper O.D.: 121 (4,76)</p> <p>Upper I.D.: 54 (2,13)</p> <p>Lower I.D.: 9,5 (0,37)</p>	<p>CH-12712</p>  <p>Worthington 522082536</p> <p>Overall Height: 119 (4,69)</p> <p>Upper O.D.: 49 (1,93)</p> <p>Lower O.D.: 148 (5,83)</p> <p>Upper I.D.: 47,8 (1,88)</p>

PRODUCT GUIDE

L'altezza non include la guarnizione/ Height not include gasket
 O.D. = diam. est. I.D. = diam. int.; Upper = Superiore ; Lower = Inferiore
 * = Cartuccia in rete metallica / Metallic net element
 ◇ = Cartuccia con termini di consegna a richiesta / Element with lead time to agree





















<p>CH-12713</p>  <p>Worthington 522082537</p> <p>Overall Height: 146 (5,75) Upper O.D.: 80 (3,15) Lower O.D.: 204 (8,03) Upper I.D.: 78,8 (3,10)</p>	<p>CH-12781</p>  <p>Air Maze CD1221B05826</p> <p>Overall Height: 456 (17,95) Upper O.D.: 254 (10,00) Upper I.D.: 170 (6,69) Lower I.D.: 11 (0,43)</p>	<p>CH-12818 *</p>  <p>Overall Height: 94 (3,70) Upper O.D.: 183 (7,20) Upper I.D.: 106 (4,17) Lower I.D.: 9,5 (0,37)</p>
<p>CH-12716</p>  <p>Komatsu Dresser 3EB0125830; Kubota 15741-11080 (For Inner Air Use ST-16872)</p> <p>Overall Height: 253 (9,96) Upper O.D.: 146 (5,75) Lower O.D.: 104 (4,09) Upper I.D.: 7 (0,28) Lower I.D.: 64,5 (2,54)</p>	<p>CH-12790</p>  <p>Donaldson P77-2530</p> <p>Overall Height: 406 (15,98) Upper O.D.: 234 (9,21) Lower O.D.: 279 (10,98) Upper I.D.: 124 (4,88) Lower I.D.: 7/16 UNF-20</p>	<p>CH-12825</p>  <p>Iveco 1905983</p> <p>Overall Height: 286 (11,26) Upper O.D.: 243 (9,57) Upper I.D.: 132 (5,20) Lower I.D.: 11 (0,43)</p>
<p>CH-12739</p>  <p>Hitachi 4294845; Donaldson P81-5267</p> <p>Overall Height: 178 (7,01) Upper O.D.: 128 (5,04) Lower O.D.: 109 (4,29) Upper I.D.: 10,5 (0,41) Lower I.D.: 43 (1,69)</p>	<p>CH-12794</p>  <p>Massey Ferguson 3389793M2; Ford 452529</p> <p>Overall Height: 406 (15,98) Upper O.D.: 265 (10,43) Lower O.D.: 317,5 (12,50) Upper I.D.: 153 (6,02) Lower I.D.: 7/16 UNF-20</p>	<p>CH-12826</p>  <p>Volvo 347138; Mann C21295</p> <p>Overall Height: 275 (10,83) Upper O.D.: 213 (8,39) Lower O.D.: 235 (9,25) Upper I.D.: 105 (4,13) Lower I.D.: 9 (0,35)</p>
<p>CH-12752</p>  <p>Leyland ACU2889</p> <p>Overall Height: 279 (10,98) Upper O.D.: 234 (9,21) Upper I.D.: 124 (4,88) Lower I.D.: 16,5 (0,65)</p>	<p>CH-12798</p>  <p>Liebherr 7405233; Poclain M2150534;</p> <p>Overall Height: 406 (15,98) Upper O.D.: 276,5 (10,89) Lower O.D.: 254 (10,00) Upper I.D.: 7/16 UNF-20 Lower I.D.: 123 (4,84)</p>	<p>CH-12839</p>  <p>Ingersoll-Rand 92058885; Petter ZPF356</p> <p>Overall Height: 67 (2,64) Upper O.D.: 132,5 (5,22) Upper I.D.: 78 (3,07)</p>
<p>CH-12770</p>  <p>Donaldson P77-5687 ; Komatsu 3EA-01-18130</p> <p>Overall Height: 254 (10,00) Upper O.D.: 150 (5,91) Lower O.D.: 129 (5,08) Upper I.D.: 17 (0,67) Lower I.D.: 63 (2,48)</p>	<p>CH-12809</p>  <p>Mercedes Benz 20947004</p> <p>Overall Height: 292 (11,50) Upper O.D.: 150 (5,91) Upper I.D.: 71 (2,80) Lower I.D.: 10,5 (0,41)</p>	<p>CH-12843</p>  <p>Ingersoll-Rand 39708466</p> <p>Overall Height: 121 (4,76) Upper O.D.: 277 (10,91) Upper I.D.: 157 (6,18)</p>
<p>CH-12775</p>  <p>Kubota 1735111080 new</p> <p>Overall Height: 280 (11,02) Upper O.D.: 180 (7,09) Lower O.D.: 134 (5,28) Upper I.D.: 13,6 (0,54) Lower I.D.: 72 (2,83)</p>	<p>CH-12817</p>  <p>Special</p> <p>Overall Height: 197 (7,76) Upper O.D.: 150 (5,91) Upper I.D.: 71 (2,80) Lower I.D.: 12,5 (0,49)</p>	<p>CH-12847</p>  <p>Ingersoll-Rand 39125547; GMC 8994542</p> <p>Overall Height: 74 (2,91) Upper O.D.: 199 (7,83) Upper I.D.: 105 (4,13)</p>

PRODUCT GUIDE

L'altezza non include la guarnizione/ Height not include gasket
 O.D. = diam. est. I.D. = diam. int.; Upper = Superiore ; Lower = Inferiore
 * = Cartuccia in rete metallica / Metallic net element
 ◇ = Cartuccia con termini di consegna a richiesta / Element with lead time to agree















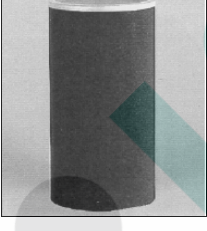

<p>CH-12857 Coopers AZA251T</p>  <p>Overall Height: 359 (14,13) Upper O.D.: 164 (6,46) Lower O.D.: 192 (7,56) Upper I.D.: 98 (3,86) Lower I.D.: 16 (0,63)</p>	<p>CH-12980 Mercedes Benz 10949604; Mann C17225</p>  <p>Overall Height: 340 (13,39) Upper O.D.: 164 (6,46) Lower O.D.: 200,5 (7,89) Upper I.D.: 86 (3,39) Lower I.D.: 9 (0,35)</p>	<p>CH-13115 Mann C 1313; Ingersoll-Rand 92888718</p>  <p>Overall Height: 120 (4,72) Upper O.D.: 112 (4,41) Lower O.D.: 66,5 (2,62) Upper I.D.: 50 (1,97)</p>
<p>CH-12867 Ford D6NN9R500B</p>  <p>Overall Height: 342 (13,46) Upper O.D.: 72 (2,83) Upper I.D.: 60,5 (2,38) Lower I.D.: 11,8 (0,46)</p>	<p>CH-12985 Pneumofore 040428</p>  <p>Overall Height: 163 (6,42) Upper O.D.: 93 (3,66) Upper I.D.: 44 (1,73) Lower I.D.: 8,5 (0,33)</p>	<p>CH-13116 Mann C 1368; Ingersoll-Rand 92889534</p>  <p>Overall Height: 151 (5,94) Upper O.D.: 130 (5,12) Lower O.D.: 88,5 (3,48) Upper I.D.: 76 (2,99)</p>
<p>CH-12870 Farymann 5410612; Knecht AG-300</p>  <p>Overall Height: 164 (6,46) Upper O.D.: 126 (4,96) Upper I.D.: 65 (2,56) Lower I.D.: 9 (0,35)</p>	<p>CH-13050 Leyland ACU3994, ERF 943042</p>  <p>Overall Height: 473 (18,62) Upper O.D.: 244 (9,61) Lower O.D.: 220 (8,66) Upper I.D.: M10 x 1,5 Lower I.D.: 131 (5,16)</p>	<p>CH-13141 Caterpillar 9S-9972; (For Outer Air Use CH-12214)</p>  <p>Overall Height: 333 (13,11) Upper O.D.: 230 (9,06) Lower O.D.: 160 (6,30) Upper I.D.: 117 (4,61)</p>
<p>CH-12884 Painting Plants</p>  <p>Overall Height: 600 (23,62) Upper O.D.: 324 (12,76) Upper I.D.: 214 (8,43) Lower I.D.: 214 (8,43)</p>	<p>CH-13074 O. & K. 101158; Same 242292001; John Deere RE35523; Donaldson P77-2552</p>  <p>Overall Height: 290 (11,42) Upper O.D.: 180 (7,09) Lower O.D.: 140 (5,51) Upper I.D.: 7/16 UNF-20 Lower I.D.: 72 (2,83)</p>	<p>CH-13150 Caterpillar 2S-1287 (For Outer Air Use CH-12210)</p>  <p>Overall Height: 446 (17,56) Upper O.D.: 230 (9,06) Lower O.D.: 160 (6,30) Upper I.D.: 117 (4,61)</p>
<p>CH-12888 Pneumofore 040907</p>  <p>Overall Height: 160 (6,30) Upper O.D.: 104 (4,09) Upper I.D.: 63 (2,48) Lower I.D.: 8,5 (0,33)</p>	<p>CH-13075 Fiat Agri 1930536; Donaldson P77-2565</p>  <p>Overall Height: 342 (13,46) Upper O.D.: 180 (7,09) Lower O.D.: 138 (5,43) Upper I.D.: 7/16 UNF-20 Lower I.D.: 72 (2,83)</p>	<p>CH-13156 Caterpillar 2S-1286, 4M-9335, 4M-9339; (For Outer Air Use CH-12214)</p>  <p>Overall Height: 371 (14,61) Upper O.D.: 230 (9,06) Lower O.D.: 160 (6,30) Upper I.D.: 117 (4,61)</p>
<p>CH-12953 Mann C1112; Crosland 9009</p>  <p>Overall Height: 70 (2,76) Upper O.D.: 98 (3,86) Upper I.D.: 60 (2,36)</p>	<p>CH-13090 Awd 91112964; Coopers AZA409</p>  <p>Overall Height: 354 (13,92) Upper O.D.: 196,3 (7,73) Lower O.D.: 229,3 (9,03) Upper I.D.: 128,5 (5,06) Lower I.D.: 16,5 (0,65)</p>	<p>CH-13157 Caterpillar 2S-1285, 4M-8048; (For Outer Air Use CH-12208)</p>  <p>Overall Height: 344 (13,54) Upper O.D.: 185 (7,28) Lower O.D.: 121 (4,76) Upper I.D.: 92 (3,62)</p>

PRODUCT GUIDE

L'altezza non include la guarnizione/ Height not include gasket
 O.D. = diam. est. I.D. = diam. int.; Upper = Superiore ; Lower = Inferiore
 * = Cartuccia in rete metallica / Metallic net element
 ◇ = Cartuccia con termini di consegna a richiesta / Element with lead time to agree

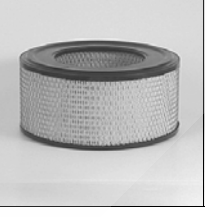









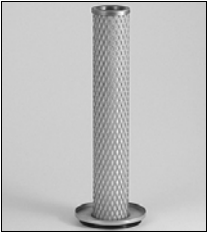





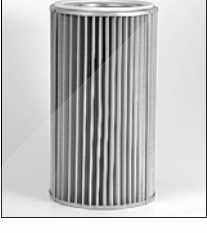

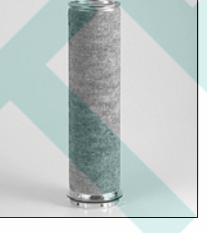

<p>CH-13173</p>  <p>Overall Height: 340 (13,39) Upper O.D.: 324 (12,76) Upper I.D.: 214 (8,43) Lower I.D.: 13 (0,51)</p>	<p>CH-13294 Iseki 1550-104-202-00</p>  <p>Overall Height: 236 (9,29) Upper O.D.: 127 (5,00) Lower O.D.: 83 (3,27) Upper I.D.: 6 (0,24) Lower I.D.: 46 (1,81)</p>	<p>CH14-13356 Donaldson P11-8211; IHC 627975-C1</p>  <p>Overall Height: 508 (20,00) Upper O.D.: 282 (11,10) Upper I.D.: 171 (6,73) Lower I.D.: 17 (0,67)</p>
<p>CH-13177</p>  <p>Overall Height: 180 (7,09) Upper O.D.: 90 (3,54) Upper I.D.: 60 (2,36) Lower I.D.: 8,5 (0,33)</p>	<p>CH-13296 Iseki 1444-101-3700-0</p>  <p>Overall Height: 236 (9,29) Upper O.D.: 109,5 (4,31) Lower O.D.: 85 (3,35) Upper I.D.: 46 (1,81) Lower I.D.: 11 (0,43)</p>	<p>SC14-13357 Donaldson P11-8216; IHC 627976-C1; (For Outer Air Use CH-13356)</p>  <p>Overall Height: 508 (20,00) Upper O.D.: 195 (7,68) Lower O.D.: 162,5 (6,40) Upper I.D.: 134 (5,28) Lower I.D.: 17 (0,67)</p>
<p>CH-13185 JCB 32903001</p>  <p>Overall Height: 250 (9,84) Upper O.D.: 150 (5,91) Lower O.D.: 174 (6,85) Upper I.D.: 71 (2,80) M10 x 1,5</p>	<p>CH-13297 Iseki 1427-101-0140-0</p>  <p>Overall Height: 161 (6,34) Upper O.D.: 90,5 (3,56) Upper I.D.: 41,5 (1,63) Lower I.D.: 7 (0,28)</p>	<p>CH-13366 ◇ Officine Forlivesi</p>  <p>Overall Height: 100 (3,94) Upper O.D.: 183 (7,20) Upper I.D.: 107 (4,21) Lower I.D.: 9,5 (0,37)</p>
<p>CH-13190 Permatic FA 1456</p>  <p>Overall Height: 375 (14,76) Upper O.D.: 188 (7,40) Upper I.D.: 14 (0,55) Lower I.D.: 160 (6,30)</p>	<p>CH-13300 Special</p>  <p>Overall Height: 189 (7,44) Upper O.D.: 155 (6,10) Upper I.D.: 88 (3,46) Lower I.D.: 18 (0,71)</p>	<p>CH-13371 ◇ C.A.V. K 2-91</p>  <p>Overall Height: 334 (13,15) Upper O.D.: 324 (12,76) Upper I.D.: 214 (8,43) Lower I.D.: 13 (0,51)</p>
<p>CH-13205 Ingersoll-Rand 92867357</p>  <p>Overall Height: 382 (15,04) Upper O.D.: 164 (6,46) Lower O.D.: 192 (7,56) Upper I.D.: 98 (3,86) M10 x 1,5</p>	<p>CH-13310 Special</p>  <p>Overall Height: 165 (6,50) Upper O.D.: 85 (3,35) Upper I.D.: 56 (2,20) Lower I.D.: 17 (0,67)</p>	<p>CH-13400 SC polyester</p>  <p>Overall Height: 600 (23,62) Upper O.D.: 324 (12,76) Upper I.D.: 214 (8,43) Lower I.D.: 13 (0,51)</p>
<p>CH-13270 JCB 32903601</p>  <p>Overall Height: 382 (15,02) Upper O.D.: 214 (8,43) Lower O.D.: 198 (7,80) Upper I.D.: M10 x 1,5 Lower I.D.: 88 (3,46)</p>	<p>CH-13349 Lugli 2754235</p>  <p>Overall Height: 235 (9,25) Upper O.D.: 166 (6,54) Upper I.D.: 86,5 (3,41)</p>	<p>CH-13404 Lister Petter 38207903</p>  <p>Overall Height: 342 (13,46) Upper O.D.: 174 (6,85) Lower O.D.: 140 (5,51) Upper I.D.: 7/16 UNF-20 Lower I.D.: 72 (2,83)</p>

PRODUCT GUIDE





















L'altezza non include la guarnizione/ Height not include gasket
 O.D. = diam. est. I.D. = diam. int.; Upper = Superiore ; Lower = Inferiore
 * = Cartuccia in rete metallica / Metallic net element
 ◇ = Cartuccia con termini di consegna a richiesta / Element with lead time to agree

<p>ST-13410</p>  <p>Donaldson P12-0307; Wix 4567; (For Outer Air Use CH05-11467)</p> <p>Overall Height: 330 (12,99)</p> <p>Upper O.D.: 60,7 (2,39) Lower O.D.: 115,5 (4,55)</p> <p>Upper I.D.: 17 (0,67) Lower I.D.: 48,5 (1,91)</p>	<p>CH-13473</p>  <p>Donaldson P77-2597; Komatsu 2050173570</p> <p>Overall Height: 440 (17,32)</p> <p>Upper O.D.: 279 (10,98) Lower O.D.: 201 (7,91)</p> <p>Upper I.D.: 7/16 UNF-20 Lower I.D.: 135 (5,31)</p>	<p>CH-13510</p>  <p>Massey-Ferguson 1698675M2; (For Inner Air Use CH-13520)</p> <p>Overall Height: 230 (9,04)</p> <p>Upper O.D.: 108 (4,25) Lower O.D.: 115 (4,53)</p> <p>Upper I.D.: 67 (2,64) Lower I.D.: 9,5 (0,37)</p>
<p>CH-13423 *</p>  <p>Overall Height: 202 (7,95)</p> <p>Upper O.D.: 163 (6,42)</p> <p>Upper I.D.: 98 (3,86) Lower I.D.: 8,5 (0,33)</p>	<p>CH-13477</p>  <p>Fiat Agri 1930174</p> <p>Overall Height: 330 (12,99)</p> <p>Upper O.D.: 276,5 (10,89) Lower O.D.: 234 (9,21)</p> <p>Upper I.D.: 7/16 UNF-20 Lower I.D.: 123 (4,84)</p>	<p>CH-13520</p>  <p>Massey-Ferguson 1698676M1; (For Outer Air Use CH-13510)</p> <p>Overall Height: 209 (8,23)</p> <p>Upper O.D.: 66 (2,60)</p> <p>Upper I.D.: 41 (1,61) Lower I.D.: 8,5 (0,33)</p>
<p>CH-13424 *</p>  <p>Overall Height: 335 (13,19)</p> <p>Upper O.D.: 163 (6,42)</p> <p>Upper I.D.: 98 (3,86) Lower I.D.: 8,5 (0,33)</p>	<p>CH-13489</p>  <p>Fini 017027000</p> <p>Overall Height: 78 (3,07)</p> <p>Upper O.D.: 207 (8,15) Upper I.D.: 153 (6,02)</p>	<p>ST-13527</p>  <p>Volvo 4785746; Mann CF1200; (For Outer Air Use CH-12242)</p> <p>Overall Height: 379 (14,92)</p> <p>Upper O.D.: 114 (4,49) Lower O.D.: 121 (4,76)</p> <p>Upper I.D.: 17 (0,67) Lower I.D.: 105 (4,13)</p>
<p>CH-13459 ◇ C.A.V. FC 405</p>  <p>Overall Height: 400 (15,75)</p> <p>Upper O.D.: 324 (12,76)</p> <p>Upper I.D.: 214 (8,43) Lower I.D.: 13 (0,51)</p>	<p>CH-13495 *</p>  <p>Overall Height: 497 (19,57)</p> <p>Upper O.D.: 282 (11,10)</p> <p>Upper I.D.: 171 (6,73) Lower I.D.: 17 (0,67)</p>	<p>ST-13528</p>  <p>Mann CF1600; Ingersoll-Rand 92035955; (For Outer Air Use CH-12278)</p> <p>Overall Height: 470 (18,50)</p> <p>Upper O.D.: 155 (6,10) Lower O.D.: 162 (6,38)</p> <p>Upper I.D.: 17 (0,67) Lower I.D.: 145 (5,71)</p>
<p>CH-13460 ◇ C.A.V. K 5-38</p>  <p>Overall Height: 500 (19,69)</p> <p>Upper O.D.: 324 (12,76)</p> <p>Upper I.D.: 214 (8,43) Lower I.D.: 13 (0,51)</p>	<p>CH-13500</p>  <p>Bottarini 220918</p> <p>Overall Height: 48 (1,89)</p> <p>Upper O.D.: 242 (9,53) Upper I.D.: 194 (7,64)</p>	<p>ST-13529</p>  <p>Mann CF1300; Volvo 4785749; (For Outer Air Use CH-12235)</p> <p>Overall Height: 479 (18,86)</p> <p>Upper O.D.: 130 (5,12) Lower O.D.: 140 (5,51)</p> <p>Upper I.D.: 17 (0,67) Lower I.D.: 125 (4,92)</p>
<p>CH-13467</p>  <p>S.B. Machinery 20580020</p> <p>Overall Height: 92 (3,62)</p> <p>Upper O.D.: 215 (8,46) Upper I.D.: 146 (5,75)</p>	<p>CH-13506</p>  <p>Officine Fortivesi</p> <p>Overall Height: 197 (7,76)</p> <p>Upper O.D.: 121 (4,76)</p> <p>Upper I.D.: 75 (2,95) Lower I.D.: 9,5 (0,37)</p>	<p>ST-13530</p>  <p>Mann CF800; Bomag 5821015; Volvo 4765611 (For Outer Air Use CH-12386)</p> <p>Overall Height: 345 (13,58)</p> <p>Upper O.D.: 82 (3,23) Lower O.D.: 90 (3,54)</p> <p>Upper I.D.: 17 (0,67) Lower I.D.: 72 (2,83)</p>

PRODUCT GUIDE





L'altezza non include la guarnizione/ Height not include gasket
 O.D. = diam. est. I.D. = diam. int.; Upper = Superiore ; Lower = Inferiore
 * = Cartuccia in rete metallica / Metallic net element
 ◇ = Cartuccia con termini di consegna a richiesta / Element with lead time to agree

<p>ST-13531</p>  <p>Bomag 5821014; Mann CF1000; (For Outer Air Use CH-12385)</p> <p>Overall Height: 370 (14,57)</p> <p>Upper O.D.: 99 (3,90) Lower O.D.: 108 (4,25)</p> <p>Upper I.D.: 17 (0,67) Lower I.D.: 89 (3,50)</p>	<p>CH-13577</p>  <p>Overall Height: 400 (15,75)</p> <p>Upper O.D.: 234 (9,21)</p> <p>Upper I.D.: 133 (5,24) Lower I.D.: 16,5 (0,65)</p>	<p>SC12-13636</p>  <p>Iveco Aifo 08019343 ; (For Outer Air Use CH12-13632)</p> <p>Overall Height: 450 (17,72)</p> <p>Upper O.D.: 148 (5,83) Lower O.D.: 117 (4,61)</p> <p>Upper I.D.: 88 (3,46) Lower I.D.: 17 (0,67)</p>
<p>CH-13561</p>  <p>Special</p> <p>Overall Height: 340 (13,39)</p> <p>Upper O.D.: 165 (6,50) Lower O.D.: 201 (7,91)</p> <p>Upper I.D.: 118 (4,65) Lower I.D.: 8,5 (0,33)</p>	<p>CH-13579</p>  <p>Overall Height: 205 (8,07)</p> <p>Upper O.D.: 164 (6,46)</p> <p>Upper I.D.: 86 (3,39) Lower I.D.: 9 (0,35)</p>	<p>CH-13644</p>  <p>Nissan 165461G000; Mann C13131</p> <p>Overall Height: 224 (8,82)</p> <p>Upper O.D.: 126 (4,96)</p> <p>Upper I.D.: 126 (4,96) Lower I.D.: 65 (2,56)</p>
<p>CH-13562</p>  <p>Piovan</p> <p>Overall Height: 200 (7,87)</p> <p>Upper O.D.: 183 (7,20)</p> <p>Upper I.D.: 120 (4,72) Lower I.D.: 9,5 (0,37)</p>	<p>CH-13591</p>  <p>Painting Plants</p> <p>Overall Height: 600 (23,62)</p> <p>Upper O.D.: 324 (12,76)</p> <p>Upper I.D.: 214 (8,43) Lower I.D.: 214 (8,43)</p>	<p>CH-13692</p>  <p>Special</p> <p>Overall Height: 460 (18,11)</p> <p>Upper O.D.: 282 (11,10)</p> <p>Upper I.D.: 198 (7,80) Lower I.D.: 17 (0,67)</p>
<p>CH-13569 ◇</p>  <p>Overall Height: 400 (15,75)</p> <p>Upper O.D.: 234 (9,21)</p> <p>Upper I.D.: 133 (5,24) Lower I.D.: 16,5 (0,65)</p>	<p>CH-13597</p>  <p>Iseki Old Version</p> <p>Overall Height: 189 (7,44)</p> <p>Upper O.D.: 150 (5,91) Lower O.D.: 140 (5,51)</p> <p>Upper I.D.: 7 (0,28) Lower I.D.: 63 (2,48)</p>	<p>CH-13763</p>  <p>Mann C331476; Iveco 1905710</p> <p>Overall Height: 458 (18,03)</p> <p>Upper O.D.: 327 (12,87)</p> <p>Upper I.D.: 216 (8,50) Lower I.D.: 16 (0,63)</p>
<p>CH-13573</p>  <p>Overall Height: 340 (13,39)</p> <p>Upper O.D.: 164 (6,46)</p> <p>Upper I.D.: 86 (3,39) Lower I.D.: 9 (0,35)</p>	<p>CH-13623</p>  <p>Iseki Old Version of CH-12716</p> <p>Overall Height: 255 (10,04)</p> <p>Upper O.D.: 150 (5,91) Lower O.D.: 104 (4,09)</p> <p>Upper I.D.: 7 (0,28) Lower I.D.: 63 (2,48)</p>	<p>CH-13771</p>  <p>Overall Height: 838 (32,99)</p> <p>Upper O.D.: 327 (12,87)</p> <p>Upper I.D.: 255 (10,04) Lower I.D.: 16 (0,63)</p>
<p>CH-13575 ◇ Special</p>  <p>Overall Height: 271 (10,67)</p> <p>Upper O.D.: 180 (7,09) Lower O.D.: 133 (5,24)</p> <p>Upper I.D.: 13,5 (0,53) Lower I.D.: 72 (2,83)</p>	<p>CH12-13632</p>  <p>Iveco Aifo 08019342 ; (For Inner Air Use SC12-13636)</p> <p>Overall Height: 456 (17,95)</p> <p>Upper O.D.: 292 (11,50) Lower O.D.: 234 (9,21)</p> <p>Upper I.D.: 124 (4,88) Lower I.D.: 16,5 (0,65)</p>	<p>CH-13797 *</p>  <p>Overall Height: 497 (19,57)</p> <p>Upper O.D.: 282 (11,10)</p> <p>Upper I.D.: 198 (7,80) Lower I.D.: 17 (0,67)</p>

PRODUCT GUIDE

L'altezza non include la guarnizione/ Height not include gasket
 O.D. = diam. est. I.D. = diam. int.; Upper = Superiore ; Lower = Inferiore
 * = Cartuccia in rete metallica / Metallic net element
 ◇ = Cartuccia con termini di consegna a richiesta / Element with lead time to agree















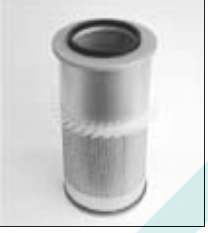

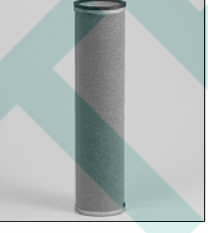
<p>CH-13811 Manitou 177130</p>  <p>Overall Height: 296 (11,65) Upper O.D.: 196 (7,72) Lower O.D.: 15 (0,59) Upper I.D.: 92,5 (3,64) Lower I.D.: 18 (0,71)</p>	<p>CH-13889 RVI 50 00 814 957</p>  <p>Overall Height: 336 (13,23) Upper O.D.: 188 (7,40) Upper I.D.: 160 (6,30) Lower I.D.: 14,5 (0,57)</p>	<p>CH-13982 Centralized hoovers</p>  <p>Overall Height: 145 (5,71) Upper O.D.: 120 (4,72) Upper I.D.: 70 (2,76) Lower I.D.: 6,5 (0,26)</p>
<p>CH-13818 Manitou 185578</p>  <p>Overall Height: 374 (14,72) Upper O.D.: 196 (7,72) Lower O.D.: 155 (6,10) Upper I.D.: 92,5 (3,64) Lower I.D.: 18 (0,71)</p>	<p>CH-13905</p>  <p>Overall Height: 508 (20,00) Upper O.D.: 282 (11,10) Upper I.D.: 171 (6,73) Lower I.D.: 17 (0,67)</p>	<p>CH-14006 Iveco Aifo 8021823 (Marine Filter)</p>  <p>Overall Height: 74 (2,91) Upper O.D.: 207 (8,15) Upper I.D.: 153 (6,02)</p>
<p>CH-13824 Manitou 177129</p>  <p>Overall Height: 273 (10,75) Upper O.D.: 162 (6,38) Lower O.D.: 134 (5,28) Upper I.D.: 70 (2,76) Lower I.D.: 18 (0,71)</p>	<p>CH-13933 (Replaced By CH-14536)</p>  <p>Overall Height: 200 (7,87) Upper O.D.: 234 (9,21) Upper I.D.: 133 (5,24) Lower I.D.: 16,5 (0,65)</p>	<p>CH-14012 ◇ Centralized hoovers</p>  <p>Overall Height: 335 (13,19) Upper O.D.: 183 (7,20) Upper I.D.: 120 (4,72) Lower I.D.: 9,5 (0,37)</p>
<p>CH-13835 Mann 4510054134; Ingersoll-Rand 93191542</p>  <p>Overall Height: 165 (6,50) Upper O.D.: 160 (6,30) Lower O.D.: 91 (3,58) Upper I.D.: 77 (3,03)</p>	<p>CH-13939 RVI 50 00 814 950; Permatic FA1462</p>  <p>Overall Height: 324 (12,76) Upper O.D.: 178 (7,01) Upper I.D.: 155 (6,10)</p>	<p>CH-14015 Gnutti 15.01.311.30</p>  <p>Overall Height: 228 (8,98) Upper O.D.: 104 (4,09) Lower O.D.: 130 (5,12) Upper I.D.: 63 (2,48) Lower I.D.: 19 (0,75)</p>
<p>CH-13848 Special</p>  <p>Overall Height: 383 (15,08) Upper O.D.: 197 (7,76) Lower O.D.: 155 (6,10) Upper I.D.: 88 (3,46) Lower I.D.: 19 (0,75)</p>	<p>CH-13947 Worthington Turbodyne 52.208.2539</p>  <p>Overall Height: 156 (6,14) Upper O.D.: 140 (5,51) Lower O.D.: 280 (11,02) Upper I.D.: 138 (5,43)</p>	<p>CH-14022 ◇ Centralized hoovers</p>  <p>Overall Height: 250 (9,84) Upper O.D.: 138 (5,43) Upper I.D.: 76 (2,99) Lower I.D.: 11 (0,43)</p>
<p>CH-13880 Iveco Aifo 8020729</p>  <p>Overall Height: 600 (23,62) Upper O.D.: 485 (19,09) Upper I.D.: 335 (13,19)</p>	<p>CH-13948 Worthington Turbodyne 52.208.2538</p>  <p>Overall Height: 316 (12,44) Upper O.D.: 180 (7,09) Lower O.D.: 280 (11,02) Upper I.D.: 178 (7,01)</p>	<p>CH-14037 ◇ Special</p>  <p>Overall Height: 52 (2,05) Upper O.D.: 89 (3,50) Upper I.D.: 47 (1,85)</p>

PRODUCT GUIDE

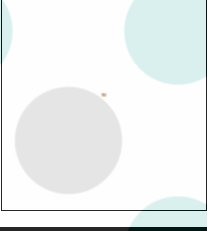

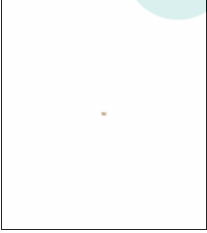















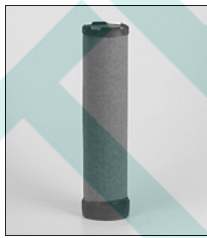

L'altezza non include la guarnizione/ Height not include gasket
 O.D. = diam. est. I.D. = diam. int.; Upper = Superiore ; Lower = Inferiore
 * = Cartuccia in rete metallica / Metallic net element
 ◇ = Cartuccia con termini di consegna a richiesta / Element with lead time to agree

<p>CH-14047 Iseki 1572-103-250-00</p>  <p>Overall Height: 254 (10,00) Upper O.D.: 150 (5,91) Lower O.D.: 104 (4,09) Upper I.D.: 14 (0,55) Lower I.D.: 63 (2,48)</p>	<p>CH-14104 John Deere AR46976</p>  <p>Overall Height: 356 (14,02) Upper O.D.: 173 (6,81) Upper I.D.: 88 (3,46) Lower I.D.: 17 (0,67)</p>	<p>CH-14152 Tecnocar A-665 ; Fiat 600 ; Fiat 600 D Multipla</p>  <p>Overall Height: 210 (8,27) Upper O.D.: 110 (4,33) Upper I.D.: 63 (2,48)</p>
<p>CH-14058 Industrial aspiration</p>  <p>Overall Height: 788 (31,02) Upper O.D.: 324 (12,76) Upper I.D.: 214 (8,43) Lower I.D.: 13 (0,51)</p>	<p>CH-14107 Daf 393561; Mann C24508</p>  <p>Overall Height: 366 (14,41) Upper O.D.: 242 (9,53) Upper I.D.: 132 (5,20) Lower I.D.: 11 (0,43)</p>	<p>CH-14154 Fiat-Hitachi 1930604 ; Donaldson P77-2587</p>  <p>Overall Height: 406 (15,98) Upper O.D.: 295 (11,61) Lower O.D.: 245,5 (9,67) Upper I.D.: 154 (6,06) Lower I.D.: 16 (0,63)</p>
<p>CH-14063 S.B. Machinery 20580300</p>  <p>Overall Height: 198 (7,80) Upper O.D.: 67 (2,64) Lower O.D.: 111 (4,37) Upper I.D.: 50 (1,97)</p>	<p>CH-14111 Iveco Aifo 8023027</p>  <p>Overall Height: 171 (6,73) Upper O.D.: 160 (6,30) Lower O.D.: 74,5 (2,93) Upper I.D.: 60,5 (2,38)</p>	<p>ST06-14160 As ST06-11109 but with bore of 17 mm.</p>  <p>Overall Height: 262 (10,31) Upper O.D.: 66 (2,60) Upper I.D.: 56 (2,20) Lower I.D.: 17 (0,67)</p>
<p>CH07-14074 Donaldson P77-2579; Atlas 2991546 ; (For Inner Air Use ST07-14270)</p>  <p>Overall Height: 329 (12,95) Upper O.D.: 142 (5,59) Lower I.D.: 82 (3,23)</p>	<p>ST-14113 Donaldson P77-0398; Same 2.4249.340.2 (For Outer Air Use CH-12290)</p>  <p>Overall Height: 283 (11,14) Upper O.D.: 50 (1,97) Lower O.D.: 92,5 (3,64) Upper I.D.: 17 (0,67) Lower I.D.: 62 (2,44)</p>	<p>ST-14183 Manitou 177179</p>  <p>Overall Height: 285 (11,22) Upper O.D.: 95,5 (3,76) Lower O.D.: 85,5 (3,37) Upper I.D.: 74,5 (2,93) Lower I.D.: 9 (0,35)</p>
<p>PF-14090 Caterpillar 4N-15</p>  <p>Overall Height: 133 (5,24) Upper O.D.: 380 (14,96) Upper I.D.: 382 (15,04)</p>	<p>ST-14120 ◇ Same 2.4249.250.2;</p>  <p>Overall Height: 332 (13,07) Upper O.D.: 46 (1,81) Lower O.D.: 93 (3,66) Lower I.D.: 65 (2,56)</p>	<p>CH-14211 Mitsubishi MD 620563</p>  <p>Overall Height: 189 (7,44) Upper O.D.: 196 (7,72) Lower O.D.: 155 (6,10) Upper I.D.: 88 (3,46) Lower I.D.: 18 (0,71)</p>
<p>PFM-14095 Caterpillar 4N-15 (Panel Marine-Type)</p>  <p>Overall Height: 133 (5,24) Upper O.D.: 380 (14,96) Upper I.D.: 382 (15,04)</p>	<p>CH-14133 Painting plants</p>  <p>Overall Height: 986 (38,82) Upper O.D.: 324 (12,76) Upper I.D.: 214 (8,43) Lower I.D.: 13 (0,51)</p>	<p>CH-14214</p>  <p>Overall Height: 220 (8,66) Upper O.D.: 120 (4,72) Upper I.D.: 70 (2,76) Lower I.D.: 6,5 (0,26)</p>

PRODUCT GUIDE

L'altezza non include la guarnizione/ Height not include gasket
 O.D. = diam. est. I.D. = diam. int.; Upper = Superiore ; Lower = Inferiore
 * = Cartuccia in rete metallica / Metallic net element
 ◇ = Cartuccia con termini di consegna a richiesta / Element with lead time to agree



<p>CH-14237</p>  <p>Massey-Ferguson 3385733M1</p> <p>Overall Height: 331 (13,03) Upper O.D.: 234 (9,21) Lower O.D.: 279 (10,98) Upper I.D.: 7/16 UNF-20 Lower I.D.: 124 (4,88)</p>	<p>CH-14334</p>  <p>Massey Ferguson 1644333M1</p> <p>Overall Height: 310 (12,20) Upper O.D.: 211 (8,31) Lower O.D.: 230 (9,06) Upper I.D.: 135 (5,31) Lower I.D.: 10 (0,39)</p>	<p>CH-14388</p>  <p>Fiat 1310636080</p> <p>Overall Height: 285 (11,22) Upper O.D.: 166 (6,54) Upper I.D.: 75 (2,95)</p>
<p>CH-14245</p>  <p>Overall Height: 60 (2,36) Upper O.D.: 120 (4,72) Upper I.D.: 70 (2,76)</p>	<p>CH-14340</p>  <p>Massey Ferguson 1644334M1</p> <p>Overall Height: 283 (11,14) Upper O.D.: 132 (5,20) Upper I.D.: 103 (4,06) Lower I.D.: 8,5 (0,33)</p>	<p>CH-14393</p>  <p>Special</p> <p>Overall Height: 253 (9,96) Upper O.D.: 130 (5,12) Lower O.D.: 104 (4,09) Upper I.D.: 63 (2,48) Lower I.D.: 18 (0,71)</p>
<p>CH-14257</p>  <p>Power System</p> <p>Overall Height: 217 (8,54) Upper O.D.: 234 (9,21) Upper I.D.: 133 (5,24) Lower I.D.: 15 (0,59)</p>	<p>ST-14343</p>  <p>Massey Ferguson 1043327-M91; Donaldson P12-3160</p> <p>Overall Height: 254 (10,00) Upper O.D.: 79 (3,11) Lower O.D.: 64,5 (2,54) Upper I.D.: 56 (2,20) Lower I.D.: 17 (0,67)</p>	<p>ST05-14402</p>  <p>New Holland 1930592; Donaldson P77-5298 ; (For Outer Air Use CH05-14409)</p> <p>Overall Height: 286 (11,26) Upper O.D.: 56 (2,20) Lower O.D.: 59 (2,32) Lower I.D.: 41 (1,61)</p>
<p>CH-14259</p>  <p>Power System</p> <p>Overall Height: 376 (14,80) Upper O.D.: 302 (11,89) Upper I.D.: 190,7 (7,51) Lower I.D.: 10,5 (0,41)</p>	<p>CH-14380</p>  <p>Fiat Agri 1930349</p> <p>Overall Height: 332 (13,07) Upper O.D.: 272 (10,71) Lower O.D.: 254,5 (10,02) Upper I.D.: 7/16 UNF-20 Lower I.D.: 123,5 (4,86)</p>	<p>CH05-14409</p>  <p>Donaldson P77-2578; Fiat Agri 1930591 ; (For Inner Air Use ST05-14402)</p> <p>Overall Height: 296 (11,65) Upper O.D.: 105 (4,13) Lower I.D.: 61 (2,40)</p>
<p>ST07-14270</p>  <p>Donaldson P77-5300; New Holland 1930588 ; (For Outer Air Use CH07-14074)</p> <p>Overall Height: 315 (12,40) Upper O.D.: 78 (3,07) Lower O.D.: 85 (3,35) Lower I.D.: 63 (2,48)</p>	<p>CH-14386</p>  <p>Fiat 1930787; Donaldson P77-1556</p> <p>Overall Height: 407 (16,02) Upper O.D.: 214 (8,43) Lower O.D.: 198 (7,80) Upper I.D.: 7/16 UNF-20 Lower I.D.: 88 (3,46)</p>	<p>CH08-14410</p>  <p>Donaldson P77-2580 ; John Deere RT6005011111 ; (For Inner Air Use ST08-14413)</p> <p>Overall Height: 342 (13,46) Upper O.D.: 162 (6,38) Lower I.D.: 90 (3,54)</p>
<p>CH-14312 * Special</p>  <p>Overall Height: 408 (16,06) Upper O.D.: 282 (11,10) Upper I.D.: 171 (6,73) Lower I.D.: 17 (0,67)</p>	<p>CH-14387</p>  <p>Iveco 1908233</p> <p>Overall Height: 342 (13,46) Upper O.D.: 154 (6,06) Lower I.D.: 80 (3,15)</p>	<p>CH04-14412</p>  <p>Donaldson P82-2686 ; (For Inner Air Use ST04-15170)</p> <p>Overall Height: 184 (7,24) Upper O.D.: 89 (3,50) Lower I.D.: 46 (1,81)</p>





PRODUCT GUIDE



L'altezza non include la guarnizione/ Height not include gasket
 O.D. = diam. est. I.D. = diam. int.; Upper = Superiore ; Lower = Inferiore
 * = Cartuccia in rete metallica / Metallic net element
 ◇ = Cartuccia con termini di consegna a richiesta / Element with lead time to agree

<p>ST08-14413</p> <p>New Holland 1930590; Donaldson P77-5302 ; (For Outer Air Use CH08-14410)</p>  <p>Overall Height: 338 (13,31) Upper O.D.: 88 (3,46) Lower O.D.: 92 (3,62) Lower I.D.: 73 (2,87)</p>	<p>CH08-14703</p> <p>Manitou 563416</p>  <p>Overall Height: 345 (13,58) Upper O.D.: 162 (6,38) Lower I.D.: 90 (3,54)</p>	<p>CH-14738 * Special</p>  <p>Overall Height: 96 (3,78) Upper O.D.: 164 (6,46) Upper I.D.: 86 (3,39) Lower I.D.: 9 (0,35)</p>
<p>CH-14425</p>  <p>Overall Height: 96 (3,78) Upper O.D.: 164 (6,46) Upper I.D.: 86 (3,39) Lower I.D.: 9 (0,35)</p>	<p>ST08-14708</p> <p>Manitou 563415</p>  <p>Overall Height: 331 (13,03) Upper O.D.: 88 (3,46) Lower O.D.: 92 (3,62) Lower I.D.: 73 (2,87)</p>	<p>CH-14746 ◇ Alup 172.07794</p>  <p>Overall Height: 111 (4,37) Upper O.D.: 54 (2,13) Lower O.D.: 120 (4,72) Upper I.D.: 40 (1,57)</p>
<p>CH10-14455</p> <p>Fiat Agri 71415282 (with black cover)</p>  <p>Overall Height: 406 (15,98) Upper O.D.: 279 (10,98) Lower O.D.: 201 (7,91) Upper I.D.: 7/16 UNF-20 Lower I.D.: 135 (5,31)</p>	<p>ST-14715</p> <p>Ford 4700K (For Outer Air use CH-14722)</p>  <p>Overall Height: 288 (11,34) Upper O.D.: 112 (4,41) Lower O.D.: 92 (3,62) Upper I.D.: 76,5 (3,01) Lower I.D.: 11 (0,43)</p>	<p>ST-14758</p> <p>Inner air of CH08-12091</p>  <p>Overall Height: 188 (7,40) Upper O.D.: 85 (3,35) Upper I.D.: 74 (2,91) Lower I.D.: 10,2 (0,40)</p>
<p>SC-14468</p> <p>Special</p>  <p>Overall Height: 263 (10,35) Upper O.D.: 116 (4,57) Upper I.D.: 88 (3,46) Lower I.D.: 17 (0,67)</p>	<p>CH-14722</p> <p>Ford 4700K (For Inner Air use ST-14715)</p>  <p>Overall Height: 324 (12,76) Upper O.D.: 189 (7,44) Lower O.D.: 196 (7,72) Upper I.D.: 96 (3,78) M10 x 1,5</p>	<p>ST-14787</p> <p>Fleetguard AF25529</p>  <p>Overall Height: 175 (6,89) Upper O.D.: 92,5 (3,64) Lower O.D.: 70 (2,76) Upper I.D.: 62 (2,44) Lower I.D.: 17 (0,67)</p>
<p>CH-14533</p> <p>New Holland 1930138</p>  <p>Overall Height: 330 (12,99) Upper O.D.: 213 (8,39) Lower O.D.: 197 (7,76) Upper I.D.: 7/16 UNF-20 Lower I.D.: 87 (3,43)</p>	<p>CH06-14733</p> <p>Donaldson SMP18-1062</p>  <p>Overall Height: 383 (15,08) Upper O.D.: 162 (6,38) Lower O.D.: 134 (5,28) Upper I.D.: 83,5 (3,29) Lower I.D.: 19 (0,75)</p>	<p>CH05-14827</p> <p>Worthington Turbodyne 52.208.2544</p>  <p>Overall Height: 253 (9,96) Upper O.D.: 104 (4,09) Upper I.D.: 63 (2,48) Lower I.D.: 18 (0,71)</p>
<p>CH-14536</p>  <p>Overall Height: 200 (7,87) Upper O.D.: 234 (9,21) Upper I.D.: 133 (5,24) Lower I.D.: 16,5 (0,65)</p>	<p>CH-14735</p> <p>Centralized Hoover</p>  <p>Overall Height: 200 (7,87) Upper O.D.: 183 (7,20) Upper I.D.: 120 (4,72) Lower I.D.: 9,5 (0,37)</p>	<p>ST08-14829</p> <p>Donaldson P77-5457 ; Donaldson P12-4165 ; Fiat - Allis 71406283</p>  <p>Overall Height: 303 (11,93) Upper O.D.: 106 (4,17) Lower O.D.: 85 (3,35) Upper I.D.: 74 (2,91) Lower I.D.: 17 (0,67)</p>

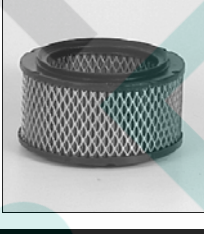
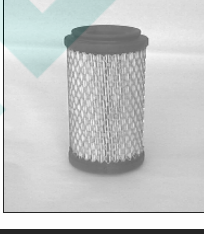
L'altezza non include la guarnizione/ Height not include gasket
 O.D. = diam. est. I.D. = diam. int.; Upper = Superiore ; Lower = Inferiore
 * = Cartuccia in rete metallica / Metallic net element
 ◇ = Cartuccia con termini di consegna a richiesta / Element with lead time to agree

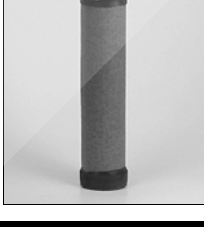
<p>CH08-14830</p> <p>Poclain T1950555 (with black cover) (For Inner Air Use ST08-11316)</p>  <p>Overall Height: 382 (15,02) Upper O.D.: 214 (8,43) Lower O.D.: 198 (7,80) Upper I.D.: 7/16 UNF-20 Lower I.D.: 88 (3,46)</p>	<p>CH-14902</p> <p>Scania 1335678; Donaldson P77-8336</p>  <p>Overall Height: 526 (20,71) Upper O.D.: 303 (11,93) Lower I.D.: 168,5 (6,63)</p>	<p>CH-15005</p> <p>Volvo 858488</p>  <p>Overall Height: 101 (3,98) Upper O.D.: 203 (7,99) Upper I.D.: 98 (3,86)</p>
<p>CH08-14835</p> <p>Fiat Hitachi 71405431; Donaldson P77-2553</p>  <p>Overall Height: 341 (13,43) Upper O.D.: 214 (8,43) Lower O.D.: 159 (6,26) Upper I.D.: 7/16 UNF-20 Lower I.D.: 88 (3,46)</p>	<p>PF-14910</p> <p>Fleetguard 3919942 GK</p>  <p>Overall Height: 150 (5,91) Upper O.D.: 350 (13,78) Upper I.D.: 450 (17,72)</p>	<p>PF-15015</p> <p>Fleetguard AF 25773 GK</p>  <p>Overall Height: 150 (5,91) Upper O.D.: 450 (17,72) Upper I.D.: 475 (18,70)</p>
<p>CH07-14865</p> <p>Manitou 227959</p>  <p>Overall Height: 322 (12,68) Upper O.D.: 142 (5,59) Lower I.D.: 82 (3,23)</p>	<p>CH-14928 *</p>  <p>Overall Height: 202 (7,95) Upper O.D.: 164 (6,46) Upper I.D.: 86 (3,39) Lower I.D.: 9 (0,35)</p>	<p>CH05-15078</p>  <p>Overall Height: 355 (13,98) Upper O.D.: 104 (4,09) Upper I.D.: 63 (2,48) Lower I.D.: 18 (0,71)</p>
<p>CH-14888</p> <p>Donaldson P77-7409 (For Inner Air Use SC-16290)</p>  <p>Overall Height: 523 (20,59) Upper O.D.: 280 (11,02) Lower I.D.: 146,5 (5,77)</p>	<p>CH-14950</p> <p>Mann C 1633/1</p>  <p>Overall Height: 76 (2,99) Upper O.D.: 160 (6,30) Upper I.D.: 120 (4,72)</p>	<p>CH04-15145</p> <p>Kubota 19458-8748-0</p>  <p>Overall Height: 179 (7,05) Upper O.D.: 89 (3,50) Lower I.D.: 41 (1,61)</p>
<p>CH-14896</p> <p>Scania 1335679; Donaldson P77-8335</p>  <p>Overall Height: 445 (17,52) Upper O.D.: 303 (11,93) Lower I.D.: 168,5 (6,63)</p>	<p>CH-14955</p> <p>(Special paper)</p>  <p>Overall Height: 788 (31,02) Upper O.D.: 324 (12,76) Upper I.D.: 214 (8,43) Lower I.D.: 13 (0,51)</p>	<p>ST04-15170</p> <p>Inner air of CH-14412</p>  <p>Overall Height: 173 (6,81) Upper O.D.: 45 (1,77) Lower I.D.: 35 (1,38)</p>
<p>CH-14900</p> <p>M.A.N. 81083040083; Donaldson P77-7579</p>  <p>Overall Height: 483 (19,02) Upper O.D.: 303 (11,93) Lower I.D.: 168,5 (6,63)</p>	<p>ST05-14980</p> <p>Same 2.4249.0403 ; (For Outer Air Use CH05-12222)</p>  <p>Overall Height: 209 (8,23) Upper O.D.: 60,7 (2,39) Lower O.D.: 115,5 (4,55) Upper I.D.: 17 (0,67) Lower I.D.: 48,5 (1,91)</p>	<p>CH-15180</p>  <p>Overall Height: 508 (20,00) Upper O.D.: 282 (11,10) Upper I.D.: 171 (6,73) Lower I.D.: 17 (0,67)</p>

PRODUCT GUIDE



L'altezza non include la guarnizione/ Height not include gasket
 O.D. = diam. est. I.D. = diam. int.; Upper = Superiore ; Lower = Inferiore
 * = Cartuccia in rete metallica / Metallic net element
 ◇ = Cartuccia con termini di consegna a richiesta / Element with lead time to agree

<p>CH-15196 *</p>  <p>Overall Height: 355 (13,98) Upper O.D.: 104 (4,09) Upper I.D.: 63 (2,48) Lower I.D.: 18 (0,71)</p>	<p>CH-15304 Donaldson P77-5804</p>  <p>Overall Height: 385 (15,16) Upper O.D.: 308 (12,13) Upper I.D.: 195 (7,68) Lower I.D.: 17 (0,67)</p>	<p>CH-15425 ◇ Massey Ferguson</p>  <p>Overall Height: 231 (9,09) Upper O.D.: 120 (4,72) Lower O.D.: 137 (5,39) Upper I.D.: 77 (3,03) Lower I.D.: 10 (0,39)</p>
<p>CH-15247 Mann C15165/3; Deutz 2165038 (without hole)</p>  <p>Overall Height: 325 (12,80) Upper O.D.: 150 (5,91) Upper I.D.: 71 (2,80)</p>	<p>CH-15310 *</p>  <p>Overall Height: 143 (5,63) Upper O.D.: 120 (4,72) Upper I.D.: 80 (3,15) Lower I.D.: 6,5 (0,26)</p>	<p>PF-15441 Volvo 8143691 ; Fleetguard AF 25305</p>  <p>Overall Height: 48 (1,89) Upper O.D.: 210 (8,27) Upper I.D.: 210 (8,27)</p>
<p>ST-15255 Fleetguard AF25702 ; Kubota 6C040.94250</p>  <p>Overall Height: 158 (6,22) Upper O.D.: 51 (2,01) Lower O.D.: 55 (2,17) Upper I.D.: 16,5 (0,65) Lower I.D.: 40 (1,57)</p>	<p>CH10-15371 Donaldson P78-1039 ; (For Inner Air Use ST10-15380)</p>  <p>Overall Height: 418 (16,46) Upper O.D.: 206 (8,11) Lower I.D.: 106,5 (4,19)</p>	<p>PF-15470 Fleetguard AF 25825 ; Deutz-Knecht AG 313</p>  <p>Overall Height: 60 (2,36) Upper O.D.: 497 (19,57) Upper I.D.: 497 (19,57)</p>
<p>CH-15267 Fleetguard AF25703K</p>  <p>Overall Height: 177 (6,97) Upper O.D.: 107 (4,21) Lower O.D.: 83 (3,27) Upper I.D.: 54 (2,13) Lower I.D.: 16,5 (0,65)</p>	<p>ST10-15380 Donaldson P77-7639 ; (For Outer Air Use CH10-15371)</p>  <p>Overall Height: 406 (15,98) Upper O.D.: 102 (4,02) Lower O.D.: 106 (4,17) Lower I.D.: 87 (3,43)</p>	<p>CH-15475 Toyota 177432360071 ; Donaldson P82-7655</p>  <p>Overall Height: 282 (11,10) Upper O.D.: 138 (5,43) Lower I.D.: 81,5 (3,21)</p>
<p>CH-15294 Donaldson P77-2585</p>  <p>Overall Height: 374 (14,72) Upper O.D.: 282 (11,10) Upper I.D.: 171 (6,73) Lower I.D.: 17 (0,67)</p>	<p>ST-15400</p>  <p>Overall Height: 278 (10,94) Upper O.D.: 75 (2,95) Upper I.D.: 62 (2,44) Lower I.D.: 11 (0,43)</p>	<p>CH-15512 Iseki 1560-103-202-50</p>  <p>Overall Height: 254 (10,00) Upper O.D.: 150 (5,91) Lower O.D.: 104 (4,09) Upper I.D.: 7 (0,28) Lower I.D.: 63 (2,48)</p>
<p>CH-15300 Donaldson P77-2521</p>  <p>Overall Height: 456 (17,95) Upper O.D.: 308 (12,13) Upper I.D.: 195 (7,68) Lower I.D.: 17 (0,67)</p>	<p>ST-15411</p>  <p>Overall Height: 203 (7,99) Upper O.D.: 75 (2,95) Upper I.D.: 62 (2,44) Lower I.D.: 11 (0,43)</p>	<p>ST-15557 Manitou 177178</p>  <p>Overall Height: 255 (10,04) Upper O.D.: 77 (3,03) Lower O.D.: 66 (2,60) Upper I.D.: 56 (2,20) Lower I.D.: 8,5 (0,33)</p>





PRODUCT GUIDE



L'altezza non include la guarnizione/ Height not include gasket
 O.D. = diam. est. I.D. = diam. int.; Upper = Superiore ; Lower = Inferiore

* = Cartuccia in rete metallica / Metallic net element

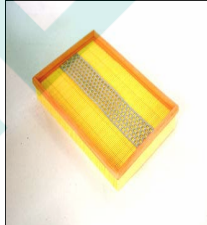
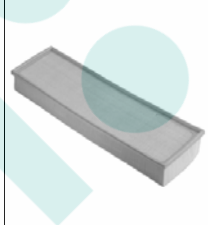
◇ = Cartuccia con termini di consegna a richiesta / Element with lead time to agree

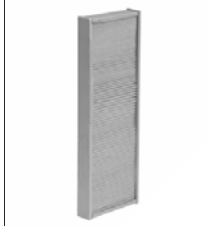
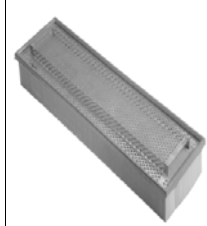
<p>CH-15565</p>  <p>Donaldson P77-2586; (For Inner Air Use SC-15604)</p> <p>Overall Height: 375 (14,76) Upper O.D.: 308 (12,13) Upper I.D.: 195 (7,68) Lower I.D.: 17 (0,67)</p>	<p>PF-15671</p>  <p>Ford EFA184 and YC15-96</p> <p>Overall Height: 57,5 (2,26) Upper O.D.: 278 (10,94) Upper I.D.: 179,5 (7,07)</p>	<p>SC-15681</p>  <p>Donaldson P77-5339 ; (For Outer Air Use CH-15673)</p> <p>Overall Height: 600 (23,62) Upper O.D.: 217 (8,54) Lower O.D.: 185 (7,28) Upper I.D.: 157 (6,18) Lower I.D.: 17 (0,67)</p>
<p>SC-15604</p>  <p>Donaldson P77-5500; (For Outer Air Use CH-15565)</p> <p>Overall Height: 368 (14,49) Upper O.D.: 217 (8,54) Lower O.D.: 185 (7,28) Upper I.D.: 157 (6,18) Lower I.D.: 17 (0,67)</p>	<p>PF-15672 ◇</p>  <p>Lautrette FA2100</p> <p>Overall Height: 51,5 (2,03) Upper O.D.: 317 (12,48) Upper I.D.: 262 (10,31)</p>	<p>PF-15683 ◇</p>  <p>Chrysler 4227087 (Panel Type)</p> <p>Overall Height: 42 (1,65) Upper O.D.: 205 (8,07) Upper I.D.: 133,6 (5,26)</p>
<p>CH-15614</p>  <p>Overall Height: 600 (23,62) Upper O.D.: 327 (12,87) Upper I.D.: 216 (8,50) Lower I.D.: 16 (0,63)</p>	<p>CH-15673</p>  <p>Donaldson P77-2581 ; (For Inner Air Use SC-15681)</p> <p>Overall Height: 610 (24,02) Upper O.D.: 308 (12,13) Upper I.D.: 195 (7,68) Lower I.D.: 17 (0,67)</p>	<p>PF-15684 ◇</p>  <p>Chrysler 4241042 and 4342800 (Panel Type)</p> <p>Overall Height: 41,6 (1,64) Upper O.D.: 273 (10,75) Upper I.D.: 133,3 (5,25)</p>
<p>CH-15633</p>  <p>Overall Height: 77 (3,03) Upper O.D.: 76 (2,99) Lower I.D.: 34 (1,34)</p>	<p>PF-15677</p>  <p>Caterpillar 6L4714 ; Fleetguard AF 4128 (Panel Type)</p> <p>Overall Height: 56 (2,20) Upper O.D.: 609 (23,98) Upper I.D.: 609 (23,98)</p>	<p>PF-15686 ◇</p>  <p>Volvo 4771477 (Panel Type)</p> <p>Overall Height: 44 (1,73) Upper O.D.: 270 (10,63) Upper I.D.: 186 (7,32)</p>
<p>PF-15660 *</p>  <p>Fleetguard FS 19615 ; Liebherr 7412710</p> <p>Overall Height: 21 (0,83) Upper O.D.: 75 (2,95) Upper I.D.: 75 (2,95)</p>	<p>PF-15679 ◇</p>  <p>Hanomag 3095 082 M1</p> <p>Overall Height: 50 (1,97) Upper O.D.: 182 (7,17) Upper I.D.: 182 (7,17)</p>	<p>PF-15688</p>  <p>Fendt F1988101400 ; Fleetguard AF 4663</p> <p>Overall Height: 55 (2,17) Upper O.D.: 602 (23,70) Upper I.D.: 110 (4,33)</p>
<p>PF-15669 ◇</p>  <p>Caterpillar 7X6041 (Panel Type)</p> <p>Overall Height: 62 (2,44) Upper O.D.: 311 (12,24) Upper I.D.: 241 (9,49)</p>	<p>PF-15680</p>  <p>Fleetguard AF 4049</p> <p>Overall Height: 30,5 (1,20) Upper O.D.: 323 (12,72) Upper I.D.: 123,5 (4,86)</p>	<p>PF-15690</p>  <p>Fleetguard AF 4915 ; Mercedes Benz 20949204</p> <p>Overall Height: 60 (2,36) Upper O.D.: 597 (23,50) Upper I.D.: 172 (6,77)</p>

PRODUCT GUIDE













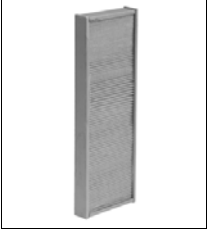

L'altezza non include la guarnizione/ Height not include gasket
 O.D. = diam. est. I.D. = diam. int.; Upper = Superiore ; Lower = Inferiore
 * = Cartuccia in rete metallica / Metallic net element
 ◇ = Cartuccia con termini di consegna a richiesta / Element with lead time to agree

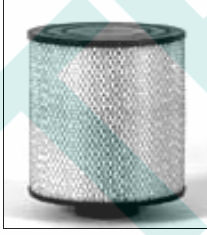
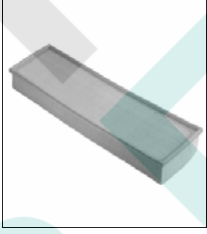
<p>PF-15693</p> <p>Fleetguard AF 4916 ; Mercedes Benz 20949304</p>  <p>Overall Height: 80 (3,15) Upper O.D.: 597 (23,50) Upper I.D.: 172 (6,77)</p>	<p>PF-15706 ◇</p>  <p>Overall Height: 70 (2,76) Upper O.D.: 332 (13,07) Upper I.D.: 266 (10,47)</p>	<p>PF-15856</p> <p>Briggs & Stratton 491588S</p>  <p>Overall Height: 20,6 (0,81) Upper O.D.: 132,6 (5,22) Upper I.D.: 112,7 (4,44)</p>
<p>PF-15695 ◇</p>  <p>Overall Height: 150 (5,91) Upper O.D.: 450 (17,72) Upper I.D.: 450 (17,72)</p>	<p>CH10-15711 (For Inner Air Use ST10-11239)</p>  <p>Overall Height: 344 (13,54) Upper O.D.: 201 (7,91) Upper I.D.: 90 (3,54) Lower I.D.: 19 (0,75)</p>	<p>PF-15857</p> <p>STIHL 42231410300 ; Fleetguard AF 25855</p>  <p>Overall Height: 47 (1,85) Upper O.D.: 88,5 (3,48) Upper I.D.: 135 (5,31)</p>
<p>CH-15696</p> <p>Mann C1417</p>  <p>Overall Height: 46 (1,81) Upper O.D.: 135 (5,31) Upper I.D.: 54 (2,13)</p>	<p>DL-15751</p> <p>Donaldson ECB12-5011 (Marine Application)</p>  <p>Overall Height: 262 (10,31) Upper O.D.: 316 (12,44) Lower I.D.: 127 (5,00)</p>	<p>PF-15858 ◇</p> <p>Antonio Carraro 45305277 (Panel Type)</p>  <p>Photo Not Available</p> <p>Overall Height: 48 (1,89) Upper O.D.: 280 (11,02) Upper I.D.: 120 (4,72)</p>
<p>PF-15699</p> <p>Mercedes Benz 0030947504</p>  <p>Overall Height: 70 (2,76) Upper O.D.: 320 (12,60) Upper I.D.: 278 (10,94)</p>	<p>CH16-15762 * Special</p>  <p>Overall Height: 455 (17,91) Upper O.D.: 307 (12,09) Upper I.D.: 196 (7,72) Lower I.D.: 17 (0,67)</p>	<p>PF-15859 ◇</p> <p>Antonio Carraro 45305278 (Panel Type)</p>  <p>Photo Not Available</p> <p>Overall Height: 50 (1,97) Upper O.D.: 300 (11,81) Upper I.D.: 169 (6,65)</p>
<p>PF-15700</p> <p>Mercedes Benz 0030948304 (Panel Type)</p>  <p>Overall Height: 80 (3,15) Upper O.D.: 320 (12,60) Upper I.D.: 278 (10,94)</p>	<p>CH-15788</p> <p>Mann C1989/1 ;</p>  <p>Overall Height: 135 (5,31) Upper O.D.: 186 (7,32) Upper I.D.: 133,5 (5,26)</p>	<p>PF-15860 ◇</p> <p>Antonio Carraro 45305574 (Panel Type)</p>  <p>Photo Not Available</p> <p>Overall Height: 55 (2,17) Upper O.D.: 400 (15,75) Upper I.D.: 130 (5,12)</p>
<p>PF-15701</p> <p>New Holland 81868102 ; Fleetguard AF 25574 ; Donaldson P78-4574</p>  <p>Overall Height: 50 (1,97) Upper O.D.: 519,5 (20,45) Upper I.D.: 104 (4,09)</p>	<p>PF-15855 ◇</p>  <p>Overall Height: 26 (1,02) Upper O.D.: 63 (2,48) Upper I.D.: 90 (3,54)</p>	<p>PF-15861 ◇</p> <p>Agritalia 047805 (Panel type)</p>  <p>Photo Not Available</p> <p>Overall Height: 55 (2,17) Upper O.D.: 600 (23,62) Upper I.D.: 90 (3,54)</p>

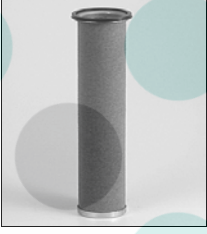
PRODUCT GUIDE



















L'altezza non include la guarnizione/ Height not include gasket
 O.D. = diam. est. I.D. = diam. int.; Upper = Superiore ; Lower = Inferiore
 * = Cartuccia in rete metallica / Metallic net element
 ◇ = Cartuccia con termini di consegna a richiesta / Element with lead time to agree

<p>PF-15862 ◇ Antonio Carraro 48013048 (Panel Type)</p> <p>Photo Not Available</p> <p>Overall Height: 55 (2,17) Upper O.D.: 590 (23,23) Upper I.D.: 100 (3,94)</p>	<p>CH05-15887 Donaldson P82-1575; New Holland 86519866; Caterpillar 31 - 2147 (For inner Air Use ST05-16108)</p>  <p>Overall Height: 273 (10,75) Upper O.D.: 105 (4,13) Lower I.D.: 62 (2,44)</p>	<p>ST06-16054 Donaldson P82-2769 ; (For Outer Air Use CH06-16050)</p>  <p>Overall Height: 299 (11,77) Upper O.D.: 78 (3,07) Lower O.D.: 82 (3,23) Lower I.D.: 63 (2,48)</p>
<p>PF-15863 ◇</p>  <p>Overall Height: 24 (0,94) Upper O.D.: 250 (9,84) Upper I.D.: 301 (11,85)</p>	<p>PF-15888 ◇ Agritalia 047210 (Panel Type)</p> <p>Photo Not Available</p> <p>Overall Height: 50 (1,97) Upper O.D.: 585 (23,03) Upper I.D.: 180 (7,09)</p>	<p>CH-16086 ◇ Piovan ; (Replaced by CH-17712)</p>  <p>Overall Height: 400 (15,75) Upper O.D.: 234 (9,21) Upper I.D.: 138 (5,43) Lower I.D.: 16,5 (0,65)</p>
<p>PF-15864 ◇ Fiat Agri (Panel Type)</p> <p>Photo Not Available</p> <p>Overall Height: 55 (2,17) Upper O.D.: 500 (19,69) Upper I.D.: 140 (5,51)</p>	<p>PF-15890 ◇ Landini 3651-225-m91 (Panel Type)</p>  <p>Overall Height: 69 (2,72) Upper O.D.: 450 (17,72) Lower I.D.: 150 (5,91)</p>	<p>DL-16097</p>  <p>Overall Height: 165 (6,50) Upper O.D.: 160 (6,30) Lower I.D.: 77 (3,03)</p>
<p>PF-15866 ◇ Antonio Carraro 45305768 (Panel Type)</p> <p>Photo Not Available</p> <p>Overall Height: 55 (2,17) Upper O.D.: 400 (15,75) Upper I.D.: 355 (13,98)</p>	<p>PF-15891 Fleetguard AF 25849 ; Massey - Ferguson 3388840-M2</p>  <p>Overall Height: 61 (2,40) Upper O.D.: 880 (34,65) Upper I.D.: 135 (5,31)</p>	<p>ST05-16108 (For Outer Air Use CH05-15887)</p>  <p>Overall Height: 260 (10,24) Upper O.D.: 56 (2,20) Lower O.D.: 59 (2,32) Lower I.D.: 41 (1,61)</p>
<p>ST12-15870 (For Outer Air Use CH12-13632)</p>  <p>Overall Height: 446 (17,56) Upper O.D.: 149 (5,87) Lower O.D.: 117 (4,61) Upper I.D.: 105,5 (4,15) Lower I.D.: 17 (0,67)</p>	<p>CH-15949 Donaldson P77-1531</p>  <p>Overall Height: 406 (15,98) Upper O.D.: 317,5 (12,50) Lower O.D.: 240 (9,45) Upper I.D.: 7/16 UNF-20 Lower I.D.: 153 (6,02)</p>	<p>DL-16141 Donaldson ECB10-5006</p>  <p>Overall Height: 300 (11,81) Upper O.D.: 266 (10,47) Lower I.D.: 101 (3,98)</p>
<p>PF-15877 ◇ Fini</p>  <p>Overall Height: 62 (2,44) Upper O.D.: 597 (23,50) Upper I.D.: 172 (6,77)</p>	<p>CH06-16050 Donaldson P82-2768 ; (For Inner Air Use ST06-16054)</p>  <p>Overall Height: 311 (12,24) Upper O.D.: 128 (5,04) Lower I.D.: 84 (3,31)</p>	<p>PF-16185 Fleetguard AF 26119 ; Mc Cormick 248124A1</p>  <p>Overall Height: 56 (2,20) Upper O.D.: 470 (18,50) Upper I.D.: 116 (4,57)</p>

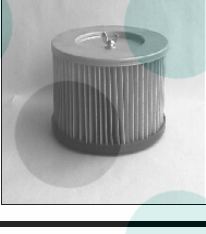
PRODUCT GUIDE



L'altezza non include la guarnizione/ Height not include gasket
 O.D. = diam. est. I.D. = diam. int.; Upper = Superiore ; Lower = Inferiore
 * = Cartuccia in rete metallica / Metallic net element
 ◇ = Cartuccia con termini di consegna a richiesta / Element with lead time to agree

<p>CH-16284 Fleetguard AF 26230</p> <p>Photo Not Available</p> <p>Overall Height: 169 (6,65) Upper O.D.: 83 (3,27) Lower O.D.: 83 (3,27) Upper I.D.: 46 (1,81) Lower I.D.: 46 (1,81)</p>	<p>CH12-16418 (For Inner Air Use ST12-16419)</p>  <p>Overall Height: 494 (19,45) Upper O.D.: 240 (9,45) Lower I.D.: 123 (4,84)</p>	<p>CH-16491 Mann C 16 400 ; (For Inner Air Use ST-16495)</p>  <p>Overall Height: 375 (14,76) Upper O.D.: 159 (6,26) Upper I.D.: 94 (3,70)</p>
<p>SC-16290 Donaldson P77-7414 (For Outer Air Use CH-14888)</p>  <p>Overall Height: 500 (19,69) Upper O.D.: 142,5 (5,61) Lower O.D.: 149,5 (5,89) Lower I.D.: 109 (4,29)</p>	<p>ST12-16419 (For Outer Air Use CH12-16418)</p>  <p>Overall Height: 475 (18,70) Upper O.D.: 119 (4,69) Lower O.D.: 123,5 (4,86) Lower I.D.: 108 (4,25)</p>	<p>CH-16492 Mann C 20 500 ; (For Inner Air Use ST-16496)</p>  <p>Overall Height: 400 (15,75) Upper O.D.: 194 (7,64) Upper I.D.: 114 (4,49)</p>
<p>CH-16294 Donaldson P77-7868 ; Terex 15270188 (For inner Air Use SC-16301)</p>  <p>Overall Height: 522 (20,55) Upper O.D.: 312 (12,28) Lower I.D.: 178 (7,01)</p>	<p>ST-16487 Mann CF 700</p>  <p>Overall Height: 327 (12,85) Upper O.D.: 68 (2,68) Lower O.D.: 80 (3,15) Upper I.D.: 17 (0,67) Lower I.D.: 66 (2,60)</p>	<p>ST-16493 Mann CF 200 ; (For Outer Air Use CH-16489)</p>  <p>Overall Height: 305 (11,99) Upper O.D.: 67 (2,64) Upper I.D.: 52 (2,05) Lower I.D.: 64,5 (2,54)</p>
<p>SC-16301 Donaldson P77-7869 ; Astra 119926 ; Terex 15270189 ; (For Outer Air Use CH-16294)</p>  <p>Overall Height: 508 (20,00) Upper O.D.: 173 (6,81) Lower O.D.: 178 (7,01) Lower I.D.: 146 (5,75)</p>	<p>ST-16488 Mann CF 600</p>  <p>Overall Height: 284 (11,18) Upper O.D.: 61,5 (2,42) Lower O.D.: 69,5 (2,74) Upper I.D.: 17 (0,67) Lower I.D.: 56,5 (2,22)</p>	<p>ST-16494 Mann CF 300 ; (For Outer Air Use CH-16490)</p>  <p>Overall Height: 345 (13,56) Upper O.D.: 77 (3,03) Upper I.D.: 62 (2,44) Lower I.D.: 74,5 (2,93)</p>
<p>CH-16378</p>  <p>Overall Height: 95 (3,74) Upper O.D.: 183 (7,20) Upper I.D.: M6 Lower I.D.: 107 (4,21)</p>	<p>CH-16489 Mann C 14 200 ; (For Inner Air Use ST-16493)</p>  <p>Overall Height: 320 (12,60) Upper O.D.: 125 (4,92) Upper I.D.: 74 (2,91)</p>	<p>ST-16495 Mann CF 400 ; (For Outer Air Use CH-16491)</p>  <p>Overall Height: 360 (14,15) Upper O.D.: 87 (3,43) Upper I.D.: 72 (2,83) Lower I.D.: 84,5 (3,33)</p>
<p>CH-16384</p>  <p>Overall Height: 102 (4,02) Upper O.D.: 101 (3,98) Lower I.D.: 67 (2,64)</p>	<p>CH-16490 Mann C 15 300 ; (For Inner Air Use ST-16494)</p>  <p>Overall Height: 360 (14,17) Upper O.D.: 149 (5,87) Upper I.D.: 84 (3,31)</p>	<p>ST-16496 Mann CF 500 ; (For Outer Air Use CH-16492)</p>  <p>Overall Height: 385 (15,14) Upper O.D.: 107 (4,21) Upper I.D.: 92 (3,62) Lower I.D.: 104,5 (4,11)</p>

PRODUCT GUIDE



L'altezza non include la guarnizione/ Height not include gasket
 O.D. = diam. est. I.D. = diam. int.; Upper = Superiore ; Lower = Inferiore
 * = Cartuccia in rete metallica / Metallic net element
 ◇ = Cartuccia con termini di consegna a richiesta / Element with lead time to agree

CH-16521  Donaldson P77-7871 (For Inner Air Use SC-16522) Overall Height: 582 (22,91) Upper O.D.: 312 (12,28) Lower I.D.: 178 (7,01)	DL-16597  Overall Height: 262 (10,31) Upper O.D.: 316 (12,44) Lower I.D.: 127 (5,00)	PF-16803  Separ 01830 Overall Height: 51 (2,01) Upper O.D.: 142,5 (5,61) Lower I.D.: 142,5 (5,61)
SC-16522  Donaldson P77-7875 (For Outer Air Use CH-16521) Overall Height: 564 (22,20) Upper O.D.: 173 (6,81) Lower O.D.: 178 (7,01) Lower I.D.: 146 (5,75)	CH-16689  Donaldson P77-7279 ; Daf 1295090 ; Ingersoll-Rand 85400737 Overall Height: 523 (20,59) Upper O.D.: 280 (11,02) Lower I.D.: 146,5 (5,77)	PF-16805  Separ 530 Overall Height: 21 (0,83) Upper O.D.: 75 (2,95) Lower I.D.: 75 (2,95)
CH-16523  Donaldson P77-0622 Overall Height: 461 (18,15) Upper O.D.: 312 (12,28) Lower I.D.: 178 (7,01)	CH09-16729  Donaldson P78-0522 Overall Height: 387 (15,22) Upper O.D.: 185 (7,28) Lower I.D.: 106 (4,17)	DL-16859  Donaldson ECB08-5034 (Marine Application) Overall Height: 314 (12,36) Upper O.D.: 217 (8,54) Lower I.D.: 76 (2,99)
CH-16533  Overall Height: 640 (25,20) Upper O.D.: 282 (11,10) Upper I.D.: 171 (6,73) Lower I.D.: 17 (0,67)	ST09-16731  Donaldson P78-0523 Overall Height: 380 (14,96) Upper O.D.: 101 (3,98) Lower O.D.: 107 (4,21) Lower I.D.: 87,5 (3,44)	DL-16862  Donaldson ECB08-5024 (Marine Application) Overall Height: 314 (12,36) Upper O.D.: 217 (8,54) Lower I.D.: 101 (3,98)
DL-16550  Donaldson ECB08-5001 Overall Height: 314 (12,36) Upper O.D.: 217 (8,54) Lower I.D.: 76 (2,99)	PF-16738  Separ 04030 Overall Height: 51 (2,01) Upper O.D.: 179 (7,05) Lower I.D.: 183 (7,20)	DL-16864  Donaldson ECB10-5013 (Marine Application) Overall Height: 300 (11,81) Upper O.D.: 266 (10,47) Lower I.D.: 101 (3,98)
DL-16560  Donaldson ECB08-5011 ; Cummins 3912020 Overall Height: 314 (12,36) Upper O.D.: 217 (8,54) Lower I.D.: 101 (3,98)	PF-16800  Fleetguard FS 19605 ; Separ 01030 Overall Height: 51 (2,01) Upper O.D.: 88 (3,46) Upper I.D.: 89 (3,50)	ST-16872  Kubota 16271-11080 (For Outer Air Use CH-12716) Overall Height: 243 (9,57) Upper O.D.: 62 (2,44) Upper I.D.: 52 (2,05) Lower I.D.: 11 (0,43)

PRODUCT GUIDE



L'altezza non include la guarnizione/ Height not include gasket
 O.D. = diam. est. I.D. = diam. int.; Upper = Superiore ; Lower = Inferiore
 * = Cartuccia in rete metallica / Metallic net element
 ◇ = Cartuccia con termini di consegna a richiesta / Element with lead time to agree

<p>CH-16873 Mann C 24 650</p>  <p>Overall Height: 497 (19,57) Upper O.D.: 242 (9,53) Lower O.D.: 309 (12,17) Upper I.D.: 132 (5,20) Lower I.D.: 10,5 (0,41)</p>	<p>ST-16879 Mann CF 820</p>  <p>Overall Height: 191 (7,52) Upper O.D.: 85 (3,35) Lower O.D.: 82,5 (3,25) Lower I.D.: 8 (0,31)</p>	<p>CH-16928 Donaldson P77-7638 ; Mann C 21 630/1 (For inner Air Use ST10-15380)</p>  <p>Overall Height: 418 (16,46) Upper O.D.: 206 (8,11) Lower I.D.: 106,5 (4,19)</p>
<p>CH-16874 Mann C 34 430</p>  <p>Overall Height: 220 (8,64) Upper O.D.: 334 (13,15) Upper I.D.: 205 (8,07)</p>	<p>ST-16880 Mann CF 711</p>  <p>Overall Height: 200 (7,85) Upper O.D.: 68 (2,68) Lower O.D.: 80 (3,15) Upper I.D.: 9 (0,35) Lower I.D.: 66 (2,60)</p>	<p>ST-16938 Volvo 1080920</p>  <p>Overall Height: 568 (22,36) Upper O.D.: 172 (6,77) Lower O.D.: 148 (5,83) Upper I.D.: 138 (5,43) Lower I.D.: 10 (0,39)</p>
<p>ST-16875 Mann CF 610 (For Outer Air Use CH-16881)</p>  <p>Overall Height: 387 (15,22) Upper O.D.: 117 (4,61) Lower O.D.: 114,5 (4,51) Lower I.D.: 102 (4,02)</p>	<p>CH-16881 Mann C 23 610 (For Inner Air Use ST-16875)</p>  <p>Overall Height: 403 (15,87) Upper O.D.: 220 (8,66) Upper I.D.: 124 (4,88)</p>	<p>CH-16969 Mann C 25 710 ; Massey - Ferguson 3902806M1 (For inner Air Use ST-16970)</p>  <p>Overall Height: 538 (21,18) Upper O.D.: 240 (9,45) Upper I.D.: 144 (5,67)</p>
<p>ST-16876 Mann CF 811</p>  <p>Overall Height: 325 (12,80) Upper O.D.: 90 (3,54) Lower O.D.: 82,5 (3,25) Upper I.D.: 76 (2,99) Lower I.D.: 11 (0,43)</p>	<p>CH-16888 Yanmar 114650-12591</p>  <p>Overall Height: 72,5 (2,85) Dim. 98 x 142 Upper I.D.: 8 (0,31)</p>	<p>ST-16970 Mann CF 710 ; Massey - Ferguson 3902812M1 (For outer Air Use CH-16969)</p>  <p>Overall Height: 522 (20,55) Upper O.D.: 135 (5,31) Lower O.D.: 138 (5,43)</p>
<p>ST-16877 Mann CF 100 (For Outer Air Use CH-16878)</p>  <p>Overall Height: 238 (9,35) Upper O.D.: 57 (2,24) Lower O.D.: 54,5 (2,15) Lower I.D.: 42 (1,65)</p>	<p>PF-16892 Iseki 1729 - 705 - 015 - 1</p>  <p>Overall Height: 55 (2,17) Upper O.D.: 602 (23,70) Upper I.D.: 110 (4,33)</p>	<p>CH-16971 Mann C 30 810 ; Atlas Copco 2914 5018 00 (For inner Air Use ST-16972)</p>  <p>Overall Height: 588 (23,15) Upper O.D.: 296 (11,65) Upper I.D.: 200 (7,87)</p>
<p>CH-16878 Mann C 11 100 (For Inner Air Use ST-16877)</p>  <p>Overall Height: 253 (9,96) Upper O.D.: 115 (4,53) Upper I.D.: 64 (2,52)</p>	<p>CH-16922 Scania 1387548 ; Mann C311495 ; Donaldson P78-1741</p>  <p>Overall Height: 522 (20,55) Upper O.D.: 312 (12,28) Lower I.D.: 178 (7,01)</p>	<p>ST-16972 Mann CF 810 ; Atlas Copco 2914 5018 00 (For outer Air Use CH-16971)</p>  <p>Overall Height: 573 (22,56) Upper O.D.: 193 (7,60) Lower O.D.: 198 (7,80)</p>

PRODUCT GUIDE



L'altezza non include la guarnizione/ Height not include gasket
 O.D. = diam. est. I.D. = diam. int.; Upper = Superiore ; Lower = Inferiore
 * = Cartuccia in rete metallica / Metallic net element
 ◇ = Cartuccia con termini di consegna a richiesta / Element with lead time to agree

<p>CH21-17070</p> <p>Donaldson P18-2040 (For inner Air Use SC21-17075)</p>  <p>Overall Height: 585 (23,03) Upper O.D.: 447 (17,60) Upper I.D.: 22 (0,87) Lower I.D.: 309 (12,17)</p>	<p>DL-17163</p> <p>Donaldson ECB10-0094 (Marine Application)</p>  <p>Overall Height: 261 (10,28) Upper O.D.: 266 (10,47) Lower I.D.: 101 (3,98)</p>	<p>DL-17329</p> <p>Donaldson ECC08-5004</p>  <p>Overall Height: 276 (10,87) Upper O.D.: 216 (8,50) Upper I.D.: 76 (2,99)</p>
<p>SC21-17075</p> <p>Donaldson P11-7781 (For outer Air Use CH21-17070)</p>  <p>Overall Height: 560 (22,05) Upper O.D.: 303 (11,93) Upper I.D.: 261 (10,28) Lower I.D.: 22 (0,87)</p>	<p>CH-17203</p> <p>Cummins AF 26439</p>  <p>Overall Height: 480 (18,90) Upper O.D.: 275,5 (10,85) Upper I.D.: 171 (6,73) Lower I.D.: 17 (0,67)</p>	<p>DL-17330</p> <p>Donaldson ECC06-5003</p>  <p>Overall Height: 161 (6,34) Upper O.D.: 165 (6,50) Upper I.D.: 57 (2,24)</p>
<p>ST-17092</p> <p>CNH 82008597</p> <p>Photo Not Available</p> <p>Overall Height: 272 (10,71) Upper O.D.: 119 (4,69) Lower O.D.: 150 (5,91) Upper I.D.: 11 (0,43) Lower I.D.: 97 (3,82)</p>	<p>CH18-17230</p> <p>Donaldson P18-2042 (For inner Air Use SC18-17232)</p>  <p>Overall Height: 610 (24,02) Upper O.D.: 374 (14,72) Upper I.D.: 263,5 (10,37) Lower I.D.: 22 (0,87)</p>	<p>DL-17331</p> <p>Donaldson ECC08-5002</p>  <p>Overall Height: 199 (7,83) Upper O.D.: 216 (8,50) Upper I.D.: 64 (2,52)</p>
<p>ST-17103</p> <p>CNH 82034441</p> <p>Photo Not Available</p> <p>Overall Height: 354 (13,94) Upper O.D.: 119 (4,69) Lower O.D.: 150 (5,91) Upper I.D.: 11,5 (0,45) Lower I.D.: 97 (3,82)</p>	<p>SC18-17232</p> <p>Donaldson P12-8408 (For outer Air Use CH18-17230)</p>  <p>Overall Height: 559 (22,01) Upper O.D.: 260 (10,24) Upper I.D.: 231 (9,09) Lower I.D.: 22 (0,87)</p>	<p>DL-17332</p> <p>Donaldson ECD06-5008 (Marine Application)</p>  <p>Overall Height: 263 (10,35) Upper O.D.: 165 (6,50) Upper I.D.: 51 (2,01)</p>
<p>DL-17111</p> <p>Donaldson ECB12-0439</p>  <p>Overall Height: 443 (17,44) Upper O.D.: 316 (12,44) Lower I.D.: 200 (7,87)</p>	<p>ST-17260</p>  <p>Overall Height: 240 (9,45) Upper O.D.: 92,5 (3,64) Lower O.D.: 70 (2,76) Upper I.D.: 62 (2,44) Lower I.D.: 8,5 (0,33)</p>	<p>DL-17333</p> <p>Donaldson ECC08-5001</p>  <p>Overall Height: 136 (5,35) Upper O.D.: 216 (8,50) Upper I.D.: 64 (2,52)</p>
<p>DL-17114</p> <p>Donaldson ECB-085056 (Marine Application)</p>  <p>Overall Height: 298 (11,73) Upper O.D.: 196 (7,72) Lower I.D.: 150 (5,91)</p>	<p>CH-17303 *</p>  <p>Overall Height: 530 (20,87) Upper O.D.: 308 (12,13) Upper I.D.: 195 (7,68) Lower I.D.: 17 (0,67)</p>	<p>DL-17335</p> <p>Donaldson ECC10-5004</p>  <p>Overall Height: 300 (11,81) Upper O.D.: 267 (10,51) Upper I.D.: 102 (4,02)</p>

PRODUCT GUIDE





L'altezza non include la guarnizione/ Height not include gasket
 O.D. = diam. est. I.D. = diam. int.; Upper = Superiore ; Lower = Inferiore
 * = Cartuccia in rete metallica / Metallic net element
 ◇ = Cartuccia con termini di consegna a richiesta / Element with lead time to agree



<p>DL-17336 Donaldson ECC12-5004</p>  <p>Overall Height: 312 (12,28) Upper O.D.: 317 (12,48) Upper I.D.: 127 (5,00)</p>	<p>CH-17531</p>  <p>Overall Height: 600 (23,62) Upper O.D.: 324 (12,76) Upper I.D.: 214 (8,43) Lower I.D.: 13 (0,51)</p>	<p>DL-17606 Lombardini ED0037004660-S</p>  <p>Overall Height: 147 (5,79) Upper O.D.: 132 (5,20) Lower I.D.: 76 (2,99)</p>
<p>CH08-17365 Donaldson P82-8889 (For Inner Air Use ST08-17366)</p>  <p>Overall Height: 347 (13,66) Upper O.D.: 164 (6,46) Lower I.D.: 90 (3,54)</p>	<p>CH-17539 Mann C 630</p>  <p>Overall Height: 69 (2,72) Upper O.D.: 60 (2,36) Upper I.D.: 34,5 (1,36)</p>	<p>PF-17644 Cummins AF 27854</p>  <p>Overall Height: 58 (2,28) Upper O.D.: 275 (10,83) Upper I.D.: 142 (5,59)</p>
<p>ST08-17366 Donaldson P82-9333 (For Outer Air Use CH08-17365)</p>  <p>Overall Height: 340 (13,39) Upper O.D.: 88 (3,46) Lower O.D.: 92 (3,62) Lower I.D.: 73 (2,87)</p>	<p>CH-17541 Mann C 1140</p>  <p>Overall Height: 79 (3,11) Upper O.D.: 100 (3,94) Upper I.D.: 67 (2,64)</p>	<p>DL-17710 Donaldson ECC06-5001</p>  <p>Overall Height: 136 (5,35) Upper O.D.: 165 (6,50) Upper I.D.: 51 (2,01)</p>
<p>ST-17470 Mann CF 2100</p>  <p>Overall Height: 610 (24,02) Upper O.D.: 201 (7,91) Lower O.D.: 209 (8,23) Upper I.D.: 17 (0,67) Lower I.D.: 192 (7,56)</p>	<p>CH-17542 Mann C 1250</p>  <p>Overall Height: 135 (5,31) Upper O.D.: 117,5 (4,63) Upper I.D.: 67 (2,64)</p>	<p>CH-17712</p>  <p>Overall Height: 400 (15,75) Upper O.D.: 234 (9,21) Upper I.D.: 138 (5,43) Lower I.D.: 16,5 (0,65)</p>
<p>CH-17490 Donaldson P82-7653</p>  <p>Overall Height: 331 (13,03) Upper O.D.: 138 (5,43) Lower I.D.: 81 (3,19)</p>	<p>CH-17594 Cummins AF 27843</p>  <p>Overall Height: 521 (20,51) Upper O.D.: 194 (7,64) Upper I.D.: 153 (6,02) Lower I.D.: 17,5 (0,69)</p>	<p>CH-17762 Cummins AF 27869</p>  <p>Overall Height: 440 (17,32) Upper O.D.: 163 (6,42) Upper I.D.: 133 (5,24) Lower I.D.: 17 (0,67)</p>
<p>CH-17512 Mann C 1132</p>  <p>Overall Height: 104 (4,09) Upper O.D.: 98 (3,86) Upper I.D.: 60 (2,36)</p>	<p>DL-17604 Lombardini ED0037004670-S</p>  <p>Overall Height: 123 (4,84) Upper O.D.: 112 (4,41) Lower I.D.: 62 (2,44)</p>	<p>DL-17823 Donaldson ECC10-5003</p>  <p>Overall Height: 186 (7,32) Upper O.D.: 267 (10,51) Upper I.D.: 100 (3,94)</p>

PRODUCT GUIDE

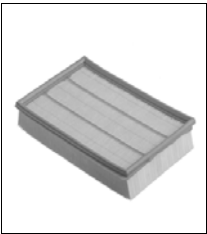

L'altezza non include la guarnizione/ Height not include gasket
 O.D. = diam. est. I.D. = diam. int.; Upper = Superiore ; Lower = Inferiore
 * = Cartuccia in rete metallica / Metallic net element
 ◇ = Cartuccia con termini di consegna a richiesta / Element with lead time to agree

<p>PF-17844</p> 	<p>Cummins AF 27866</p> <p>Overall Height: 37,5 (1,48) Upper O.D.: 500 (19,69) Upper I.D.: 174 (6,85)</p>	<p>PF-18559</p> 	<p>Cummins AF 27963</p> <p>Overall Height: 50 (1,97) Upper O.D.: 380 (14,96) Upper I.D.: 130 (5,12)</p>
--	---	--	---

<p>DL-17852</p> 	<p>Donaldson ECC08-5035</p> <p>Overall Height: 110 (4,33) Upper O.D.: 216 (8,50) Upper I.D.: 76 (2,99)</p>	<p>CH-18672</p> 	<p>Cummins AF 26659 ; Lister Petter 757-27890</p> <p>Overall Height: 270 (10,63) Upper O.D.: 104 (4,09) Upper I.D.: 63 (2,48)</p>
--	--	--	--

CH-18090



Overall Height: 87 (3,43)
 Upper O.D.: 136 (5,35)
 Lower I.D.: 78 (3,07)

PF-18174

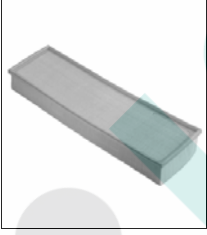

Cummins AF 27960

Overall Height: 63,5 (2,50)
 Upper O.D.: 360 (14,17)
 Upper I.D.: 263 (10,35)

CH-18334





Photo Not Available

Overall Height: 46 (1,81)
 Upper O.D.: 120 (4,72)
 Upper I.D.: 80 (3,15)

CH-18461



Overall Height: 250 (9,84)
 Upper O.D.: 308 (12,13)
 Upper I.D.: 195 (7,68)
 Lower I.D.: 17 (0,67)

Filter Listing by Dimension (Cont.)

L'altezza non include la guarnizione/ Height not include gasket
 O.D. = diam. est. I.D. = diam. int.
 * = Cartuccia in rete metallica / Metallic net element
 ◇ = Cartuccia con termini di consegna a richiesta / Element with lead time to agree



Part.No.	Height mm. inch	O.D. mm. inch	I.D. mm. inch	Part.No.	Height mm. inch	O.D. mm. inch	I.D. mm. inch	Part.No.	Height mm. inch	O.D. mm. inch	I.D. mm. inch	
CH-14133	986 38,82	324 12,76	214 8,43 13 0,51	SC-16522	564 22,20	173 6,81 178 7,01	146 5,75	CH-12238	484 19,06	242 9,53	132 5,20	
CH-13771	838 32,99	327 12,87	255 10,04 16 0,63	SC21-17075	560 22,05	303 11,93	261 10,28 22 0,87	CH-14900	483 19,02	303 11,93	168,5 6,63	
CH-11764	788 31,02	392 15,43	302 11,89 14 0,55	SC18-17232	559 22,01	260 10,24	231 9,09 22 0,87	CH-17203	480 18,90	275,5 10,85	171 6,73 17 0,67	
CH-12405	788 31,02	324 12,76	214 8,43 13 0,51	CH-12268	555 21,85	264 10,39	153 6,02	ST-13529	479 18,86	130 5,12 140 5,51	17 0,67 125 4,92	
CH-14058	788 31,02	324 12,76	214 8,43 13 0,51	◇	CH-16969	538 21,18	240 9,45	144 5,67	ST12-16419	475 18,70	119 4,69 123,5 4,86	108 4,25
CH-14955	788 31,02	324 12,76	214 8,43 13 0,51	CH-17303	530 20,87	308 12,13	195 7,68 17 0,67	CH-13050	473 18,62	244 9,61 220 8,66	M10 x 1,5 131 5,16	
CH-11020	662 26,06	324 12,76	214 8,43 13 0,51	*	CH-14902	526 20,71	303 11,93	168,5 6,63	ST-13528	470 18,50	155 6,10 162 6,38	17 0,67 145 5,71
CH-12093	656 25,83	335 13,19 280 11,02	182 7,17	CH-14888	523 20,59	280 11,02	146,5 5,77	CH-16523	461 18,15	312 12,28	178 7,01	
CH-16533	640 25,20	282 11,10	171 6,73 17 0,67	CH-16689	523 20,59	280 11,02	146,5 5,77	CH-12264	460 18,11	301,9 11,89 376 14,80	167 6,57 11 0,43	
CH-15673	610 24,02	308 12,13	195 7,68 17 0,67	CH-16294	522 20,55	312 12,28	178 7,01	◇	CH-12278	460 18,11	302 11,89	191 7,52 11 0,43
CH18-17230	610 24,02	374 14,72	263,5 10,37 22 0,87	CH-16922	522 20,55	312 12,28	178 7,01	CH-13692	460 18,11	282 11,10	198 7,80 17 0,67	
ST-17470	610 24,02	201 7,91 209 8,23	17 0,67 192 7,56	ST-16970	522 20,55	135 5,31 138 5,43		CH-13763	458 18,03	327 12,87	216 8,50 16 0,63	
CH-12289	604 23,78	200 7,87	115 4,53 11 0,43	CH-17594	521 20,51	194 7,64	153 6,02 17,5 0,69	CH-12266	457 18,00	352 13,86	240 9,45 23 0,91	
◇				CH-12282	508 20,00	324 12,76	211 8,31	◇	CH12-13632	456 17,95	292 11,50 234 9,21	124 4,88 16,5 0,65
CH-11940	600 23,62	324 12,76	214 8,43 13 0,51	◇	CH-13905	508 20,00	282 11,10	171 6,73 17 0,67	CH-12781	456 17,95	254 10,00	170 6,69 11 0,43
CH-12884	600 23,62	324 12,76	214 8,43 214 8,43	CH-13356	508 20,00	282 11,10	171 6,73 17 0,67	CH-15300	456 17,95	308 12,13	195 7,68 17 0,67	
CH-13400	600 23,62	324 12,76	214 8,43 13 0,51	CH-15180	508 20,00	282 11,10	171 6,73 17 0,67	CH16-12253	456 17,95	308 12,13	195 7,68 17 0,67	
CH-13591	600 23,62	324 12,76	214 8,43 214 8,43	SC14-13357	508 20,00	195 7,68 162,5 6,40	134 5,28 17 0,67	*	CH16-15762	455 17,91	307 12,09	196 7,72 17 0,67
CH-13880	600 23,62	485 19,09	335 13,19	SC-16301	508 20,00	173 6,81 178 7,01	146 5,75	SC12-13636	450 17,72	148 5,83 117 4,61	88 3,46 17 0,67	
CH-15614	600 23,62	327 12,87	216 8,50 16 0,63	CH-13460	500 19,69	324 12,76	214 8,43 13 0,51	◇	SC-12252	450 17,72	217 8,54 185 7,28	157 6,18 17 0,67
CH-17531	600 23,62	324 12,76	214 8,43 13 0,51	◇	SC-16290	500 19,69	142,5 5,61 149,5 5,89	109 4,29	CH-13150	446 17,56	230 9,06 160 6,30	117 4,61
SC-15681	600 23,62	217 8,54 185 7,28	157 6,18 17 0,67	CH-13495	497 19,57	282 11,10	171 6,73 17 0,67	*	ST12-15870	446 17,56	149 5,87 117 4,61	105,5 4,15 17 0,67
CH-16971	588 23,15	296 11,65	200 7,87	*	CH-13797	497 19,57	282 11,10	198 7,80 17 0,67	CH-14896	445 17,52	303 11,93	168,5 6,63
CH21-17070	585 23,03	447 17,60	22 0,87 309 12,17	CH-16873	497 19,57	242 9,53 309 12,17	132 5,20 10,5 0,41	DL-17111	443 17,44	316 12,44	200 7,87	
CH-16521	582 22,91	312 12,28	178 7,01	CH12-16418	494 19,45	240 9,45	123 4,84	CH-13473	440 17,32	279 10,98 201 7,91	7/16 UNF-20 135 5,31	
ST-16972	573 22,56	193 7,60 198 7,80		CH-12235	484 19,06	242 9,53	132 5,20 11 0,43	CH-17762	440 17,32	163 6,42	133 5,24 17 0,67	
CH-11211	568 22,36	265 10,43	153 6,02 17 0,67	CH-12236	484 19,06	210 8,27 253 9,96	103 4,06 10 0,39	◇	CH10-15371	418 16,46	206 8,11	106,5 4,19
ST-16938	568 22,36	172 6,77 148 5,83	138 5,43 10 0,39									

Filter Listing by Dimension (Cont.)

L'altezza non include la guarnizione/ Height not include gasket
 O.D. = diam. est. I.D. = diam. int.
 * = Cartuccia in rete metallica / Metallic net element
 ◇ = Cartuccia con termini di consegna a richiesta / Element with lead time to agree



Part.No.	Height mm. inch	O.D. mm. inch	I.D. mm. inch	Part.No.	Height mm. inch	O.D. mm. inch	I.D. mm. inch	Part.No.	Height mm. inch	O.D. mm. inch	I.D. mm. inch
CH-16928	418 16,46	206 8,11	106,5 4,19	CH-13569	400 15,75	234 9,21	133 5,24 16,5 0,65	CH-14259	376 14,80	302 11,89	190,7 7,51 10,5 0,41
CH10-11308	408 16,06	255 10,04 201 7,91	135 5,31 19 0,75	CH-13577	400 15,75	234 9,21	133 5,24 16,5 0,65	CH-13190	375 14,76	188 7,40	14 0,55 160 6,30
CH14-12245	408 16,06	282 11,10	171 6,73 17 0,67	CH-16086	400 15,75	234 9,21	138 5,43 16,5 0,65	CH-15565	375 14,76	308 12,13	195 7,68 17 0,67
CH-14312	408 16,06	282 11,10	171 6,73 17 0,67	CH-16492	400 15,75	194 7,64	114 4,49	CH-16491	375 14,76	159 6,26	94 3,70
CH-14386	407 16,02	214 8,43 198 7,80	7/16 UNF-20 88 3,46	CH-17712	400 15,75	234 9,21	138 5,43 16,5 0,65	CH-13818	374 14,72	196 7,72 155 6,10	92,5 3,64 18 0,71
CH-12260	407 16,00	352 13,86	240,5 9,47 17 0,67	SC10-11317	397 15,63	145 5,71 117 4,61	88 3,46 17 0,67	CH-15294	374 14,72	282 11,10	171 6,73 17 0,67
CH-12273	407 16,00	307 12,09	196 7,72 23 0,91	CH-12204	397 15,61	125 4,92	86 3,39 9 0,35	CH-13156	371 14,61	230 9,06 160 6,30	117 4,61
CH09-12244	406 15,98	224 8,82 174 6,85	107 4,21 17 0,67	CH09-16729	387 15,22	185 7,28	106 4,17	ST-13531	370 14,57	99 3,90 108 4,25	17 0,67 89 3,50
CH10-12390	406 15,98	279 10,98 201 7,91	7/16 UNF-20 135 5,31	ST-16875	387 15,22	117 4,61 114,5 4,51	102 4,02	CH-12234	369 14,53	227 8,94	117 4,61
CH10-14455	406 15,98	279 10,98 201 7,91	7/16 UNF-20 135 5,31	CH-15304	385 15,16	308 12,13	195 7,68 17 0,67	CH-12242	369 14,53	227 8,94	117 4,61 10,5 0,41
CH-12203	406 15,98	236 9,29	124 4,88 12 0,47	ST-16496	385 15,14	107 4,21	92 3,62 104,5 4,11	SC-15604	368 14,49	217 8,54 185 7,28	157 6,18 17 0,67
CH-12210	406 15,98	281,7 11,09	170,5 6,71	CH06-11295	383 15,08	162 6,38 134 5,28	92,5 3,64 19 0,75	CH-14107	366 14,41	242 9,53	132 5,20 11 0,43
CH-12286	406 15,98	194 7,64	109 4,29 17 0,67	CH06-14733	383 15,08	162 6,38 134 5,28	83,5 3,29 19 0,75	CH-12232	365 14,37	198 7,80 247 9,72	103 4,06 8,5 0,33
CH-12790	406 15,98	234 9,21 279 10,98	124 4,88 7/16 UNF-20	CH08-11288	383 15,08	199 7,83 155 6,10	88 3,46 19 0,75	CH-12387	365 14,37	302 11,89	190,7 7,51 10,5 0,41
CH-12794	406 15,98	265 10,43 317,5 12,50	153 6,02 7/16 UNF-20	CH-13848	383 15,08	197 7,76 155 6,10	88 3,46 19 0,75	CH-12385	362 14,25	198 7,80	104 4,09 8,5 0,33
CH-12798	406 15,98	276,5 10,89 254 10,00	7/16 UNF-20 123 4,84	CH-13205	382 15,04	164 6,46 192 7,56	98 3,86 M10 x 1,5	CH-11702	360 14,17	190 7,48	116 4,57
CH-14154	406 15,98	295 11,61 245,5 9,67	154 6,06 16 0,63	CH08-11935	382 15,02	214 8,43 195 7,68	7/16 UNF-20 88 3,46	CH-11808	360 14,17	190 7,48	130 5,12 11 0,43
CH-15949	406 15,98	317,5 12,50 240 9,45	7/16 UNF-20 153 6,02	CH08-14830	382 15,02	214 8,43 198 7,80	7/16 UNF-20 88 3,46	CH-11811	360 14,17	190 7,48	116 4,57 118 4,65
SC14-12254	406 15,98	195 7,68 162,5 6,40	134 5,28 17 0,67	CH-13270	382 15,02	214 8,43 198 7,80	M10 x 1,5 88 3,46	CH-16490	360 14,17	149 5,87	84 3,31
ST10-15380	406 15,98	102 4,02 106 4,17	87 3,43	SC-12274	381 15,00	194 7,64	153,5 6,04 22 0,87	ST-16495	360 14,15	87 3,43	72 2,83 84,5 3,33
CH-12276	404 15,91	234 9,21	122 4,80 17 0,67	ST09-12265	381 15,00	123 4,84 104 4,09	93 3,66 17,5 0,69	CH-12500	359 14,13	211 8,31 230 9,06	135 5,31 10 0,39
CH-12277	404 15,91	265 10,43	163 6,42	CH-12507	380 14,96	186 7,32 247 9,72	119,5 4,70 16,9 0,67	CH-12857	359 14,13	164 6,46 192 7,56	98 3,86 16 0,63
CH-12345	404 15,91	317,5 12,50 264 10,39	7/16 UNF-20 153 6,02	SC10-12395	380 14,96	117 4,61	88 3,46 17 0,67	CH-14104	356 14,02	173 6,81	88 3,46 17 0,67
CH-16881	403 15,87	220 8,66	124 4,88	ST09-16731	380 14,96	101 3,98 107 4,21	87,5 3,44	CH-12283	356 14,00	310 12,20	200 7,87 17 0,67
CH-11732	402 15,83	234 9,21	133 5,24 16,5 0,65	CH-12263	379 14,92	169 6,65 190 7,48	95 3,74 11 0,43	CH05-11467	355 13,98	131 5,16 104 4,09	63 2,48 18 0,71
CH-11738	400 15,75	234 9,21	124 4,88 16,5 0,65	ST-13527	379 14,92	114 4,49 121 4,76	17 0,67 105 4,13	CH05-15078	355 13,98	104 4,09	63 2,48 18 0,71
CH-13459	400 15,75	324 12,76	214 8,43 13 0,51	CH08-11942	378 14,88	213 8,39 197 7,76	7/16 UNF-20 87 3,43	CH-12269	355 13,98	264 10,39	153 6,02 23 0,91

Filter Listing by Dimension (Cont.)

L'altezza non include la guarnizione/ Height not include gasket
 O.D. = diam. est. I.D. = diam. int.
 * = Cartuccia in rete metallica / Metallic net element
 ◇ = Cartuccia con termini di consegna a richiesta / Element with lead time to agree



Part.No.	Height mm. inch	O.D. mm. inch	I.D. mm. inch	Part.No.	Height mm. inch	O.D. mm. inch	I.D. mm. inch	Part.No.	Height mm. inch	O.D. mm. inch	I.D. mm. inch
CH-12284	355 13,98	280 11,02	172 6,77 17 0,67	CH-13561	340 13,39	165 6,50 201 7,91	118 4,65 8,5 0,33	CH08-12228	328 12,91	199,5 7,85 155 6,10	88 3,46 17 0,67
CH-15196 *	355 13,98	104 4,09	63 2,48 18 0,71	CH-13573	340 13,39	164 6,46	86 3,39 9 0,35	ST-16487	327 12,85	68 2,68 80 3,15	17 0,67 66 2,60
ST08-11316	355 13,98	106 4,17 85 3,35	74 2,91 17 0,67	ST05-11655	340 13,39	66 2,60 62 2,44	48 1,89 8,5 0,33	CH-12231	325 12,80	150 5,91	71 2,80 9 0,35
CH-12240 ◇	354 13,94	113,5 4,47 128 5,04	57 2,24	ST08-17366	340 13,39	88 3,46 92 3,62	73 2,87	CH-15247	325 12,80	150 5,91	71 2,80
ST-17103	354 13,94	119 4,69 150 5,91	11,5 0,45 97 3,82	ST08-14413	338 13,31	88 3,46 92 3,62	73 2,87	ST-16876	325 12,80	90 3,54 82,5 3,25	76 2,99 11 0,43
CH-13090	354 13,92	196,3 7,73 229,3 9,03	128,5 5,06 16,5 0,65	CH-12279	336 13,23	132 5,20	103 4,06 8,5 0,33	CH-13939	324 12,76	178 7,01	155 6,10
ST06-11315	352 13,86	91 3,58 85 3,35	74 2,91 17 0,67	CH-13889	336 13,23	188 7,40	160 6,30 14,5 0,57	CH-14722	324 12,76	189 7,44 196 7,72	96 3,78 M10 x 1,5
CH08-17365	347 13,66	164 6,46	90 3,54	CH-13424 *	335 13,19	163 6,42	98 3,86 8,5 0,33	CH07-14865	322 12,68	142 5,59	82 3,23
CH08-14703	345 13,58	162 6,38	90 3,54	CH-14012 ◇	335 13,19	183 7,20	120 4,72 9,5 0,37	CH-12225	321 12,64	164 6,46	86 3,39
CH12-11388	345 13,58	294 11,57 234 9,21	124 4,88 16,5 0,65	CH-13371 ◇	334 13,15	324 12,76	214 8,43 13 0,51	CH-12604	320 12,60	248 9,76	143,5 5,65 M10 x 1,5
ST-13530	345 13,58	82 3,23 90 3,54	17 0,67 72 2,83	CH-13141	333 13,11	230 9,06 160 6,30	117 4,61	CH-16489	320 12,60	125 4,92	74 2,91
ST-16494	345 13,56	77 3,03	62 2,44 74,5 2,93	CH-11755 *	332 13,07	164 6,46	86 3,39 9 0,35	CH-12205	316 12,44	162 6,38 149 5,87	80,5 3,17
CH06-11941	344 13,54	170 6,69 137 5,39	M10 x 1,5 72 2,83	CH-14380	332 13,07	272 10,71 254,5 10,02	7/16 UNF-20 123,5 4,86	CH-12217 ◇	316 12,44	162 6,38	103 4,06 9 0,35
CH10-11117	344 13,54	255 10,04 201 7,91	90 3,54 19 0,75	ST-14120 ◇	332 13,07	46 1,81 93 3,66	65 2,56	CH-12219 ◇	316 12,44	163,5 6,44 190 7,48	103 4,06
CH10-15711	344 13,54	201 7,91	90 3,54 19 0,75	CH-14237	331 13,03	234 9,21 279 10,98	7/16 UNF-20 124 4,88	CH-13948	316 12,44	180 7,09 280 11,02	178 7,01
CH-13157	344 13,54	185 7,28 121 4,76	92 3,62	CH-17490	331 13,03	138 5,43	81 3,19	CH-12290	315 12,40	162 6,38 149 5,87	7/16 UNF-20 80,5 3,17
CH08-14410	342 13,46	162 6,38	90 3,54	ST08-14708	331 13,03	88 3,46 92 3,62	73 2,87	ST07-14270	315 12,40	78 3,07 85 3,35	63 2,48
CH-12867	342 13,46	72 2,83	60,5 2,38 11,8 0,46	ST12-11390	331 13,03	140 5,51 110 4,33	70 2,76 19,2 0,76	CH-12302	314 12,36	197 7,76	176 6,93 10,5 0,41
CH-13075	342 13,46	180 7,09 138 5,43	7/16 UNF-20 72 2,83	CH12-11343	330 12,99	234 9,21 275 10,83	124 4,88 14 0,55	DL-16550	314 12,36	217 8,54	76 2,99
CH-13404	342 13,46	174 6,85 140 5,51	7/16 UNF-20 72 2,83	CH12-11389	330 12,99	234 9,21	124 4,88 16,5 0,65	DL-16560	314 12,36	217 8,54	101 3,98
CH-14387	342 13,46	154 6,06	80 3,15	CH-12214	330 12,99	281,7 11,09	170,3 6,70	DL-16859	314 12,36	217 8,54	76 2,99
CH08-14835	341 13,43	214 8,43 159 6,26	7/16 UNF-20 88 3,46	CH-13477	330 12,99	276,5 10,89 234 9,21	7/16 UNF-20 123 4,84	DL-16862	314 12,36	217 8,54	101 3,98
CH-11496	340 13,39	164 6,46	86 3,39 8,5 0,33	CH-14533	330 12,99	213 8,39 197 7,76	7/16 UNF-20 87 3,43	CH-12491	312 12,28	132 5,20 146 5,75	76 2,99 10 0,39
CH-11621	340 13,39	170 6,69	91,5 3,60 8 0,31	SC12-11391	330 12,99	145 5,71 117 4,61	88 3,46 17 0,67	CH-12498	312 12,28	132 5,20 135 5,31	76 2,99 10 0,39
CH-12386	340 13,39	164 6,46	86 3,39 9 0,35	ST10-11239	330 12,99	120 4,72 85 3,35	79 3,11 10,5 0,41	DL-17336	312 12,28	317 12,48	127 5,00
CH-12980	340 13,39	164 6,46 200,5 7,89	86 3,39 9 0,35	ST-13410	330 12,99	60,7 2,39 115,5 4,55	17 0,67 48,5 1,91	CH-12255 ◇	312 12,26	132 5,20	76 2,99 Filettato
CH-13173	340 13,39	324 12,76	214 8,43 13 0,51	CH07-14074	329 12,95	142 5,59	82 3,23	CH06-16050	311 12,24	128 5,04	84 3,31

Filter Listing by Dimension (Cont.)

L'altezza non include la guarnizione/ Height not include gasket
 O.D. = diam. est. I.D. = diam. int.
 * = Cartuccia in rete metallica / Metallic net element
 ◇ = Cartuccia con termini di consegna a richiesta / Element with lead time to agree



Part.No.	Height mm. inch	O.D. mm. inch	I.D. mm. inch	Part.No.	Height mm. inch	O.D. mm. inch	I.D. mm. inch	Part.No.	Height mm. inch	O.D. mm. inch	I.D. mm. inch
CH-14334	310 12,20	211 8,31 230 9,06	135 5,31 10 0,39	CH06-11880	289 11,38	162 6,38 138 5,43	7/16 UNF-20 72 2,83	CH05-15887	273 10,75	105 4,13	62 2,44
CH-12271 ◇	307 12,07	174 6,85	88 3,46 17,5 0,69	CH-12218 ◇	288 11,34	100 3,94	76 2,99 9 0,35	CH-13824	273 10,75	162 6,38 134 5,28	70 2,76 18 0,71
CH08-12243	306 12,05	197 7,76 155 6,10	88 3,46	ST-14715	288 11,34	112 4,41 92 3,62	76,5 3,01 11 0,43	ST-17092	272 10,71	119 4,69 150 5,91	11 0,43 97 3,82
ST08-12229	305 12,01	105 4,13 85 3,35	74 2,91 17 0,67	ST08-11110	287 11,30	85 3,35	75 2,95 8,5 0,33	CH-13575 ◇	271 10,67	180 7,09 133 5,24	13,5 0,53 72 2,83
CH06-12258 ◇	305 12,00	163 6,42 133,5 5,26	70,5 2,78 19 0,75	ST08-12576	287 11,30	105 4,13 85 3,35	74 2,91 17 0,67	CH-18672	270 10,63	104 4,09	63 2,48
CH-12208	305 11,99	234 9,21	123 4,84	CH-12825	286 11,26	243 9,57	132 5,20 11 0,43	CH-12660	269 10,57	268 10,55	195 7,68
ST-16493	305 11,99	67 2,64	52 2,05 64,5 2,54	ST05-14402	286 11,26	56 2,20 59 2,32	41 1,61	CH-12241	268 10,55	113,5 4,47 128 5,04	57 2,24
CH06-11056	304 11,97	160 6,30 134 5,28	92,5 3,64 18 0,71	CH-12248	285 11,22	227 8,94	117 4,61 10,5 0,41	CH-12605	268 10,55	140 5,51	107,5 4,23 16 0,63
CH08-11003	304 11,97	197 7,76 155 6,10	88 3,46 18 0,71	CH-12653	285 11,22	121 4,76	54 2,13 9,5 0,37	CH-12212 ◇	265 10,43	160 6,30	99 3,90
CH08-11254	304 11,97	197 7,76 155 6,10	92,5 3,64 18 0,71	CH-14388	285 11,22	166 6,54	75 2,95	CH-12209 ◇	263 10,35	114 4,49	56 2,20
CH-11590	304 11,97	197 7,76 155 6,10	88 3,46 19 0,75	ST-14183	285 11,22	95,5 3,76 85,5 3,37	74,5 2,93 9 0,35	DL-17332	263 10,35	165 6,50	51 2,01
SC-12270 ◇	303 11,93	151 5,94	122 4,80 22 0,87	CH-11749	284 11,18	120 4,72	70 2,76 6,5 0,26	SC-14468	263 10,35	116 4,57	88 3,46 17 0,67
ST08-14829	303 11,93	106 4,17 85 3,35	74 2,91 17 0,67	CH-12230	284 11,18	126 4,96	65 2,56 8,5 0,33	DL-15751	262 10,31	316 12,44	127 5,00
ST-12227 ◇	303 11,93	162 6,38 133 5,24	92 3,62 19 0,75	ST-16488	284 11,18	61,5 2,42 69,5 2,74	17 0,67 56,5 2,22	DL-16597	262 10,31	316 12,44	127 5,00
DL-16141	300 11,81	266 10,47	101 3,98	CH-14340	283 11,14	132 5,20	103 4,06 8,5 0,33	SC06-11246	262 10,31	90 3,54	60 2,36 8,5 0,33
DL-16864	300 11,81	266 10,47	101 3,98	ST-14113	283 11,14	50 1,97 92,5 3,64	17 0,67 62 2,44	SC06-11269	262 10,31	90 3,54	60 2,36 8,5 0,33
DL-17335	300 11,81	267 10,51	102 4,02	CH-15475	282 11,10	138 5,43	81,5 3,21	ST06-11109	262 10,31	66 2,60	56 2,20 8,5 0,33
ST06-16054	299 11,77	78 3,07 82 3,23	63 2,48	CH06-11038	280 11,02	162 6,38 134 5,28	68 2,68 19 0,75	ST06-14160	262 10,31	66 2,60	56 2,20 17 0,67
DL-17114	298 11,73	196 7,72	150 5,91	CH06-11255	280 11,02	162 6,38 134 5,28	92,5 3,64 19 0,75	DL-17163	261 10,28	266 10,47	101 3,98
CH05-14409	296 11,65	105 4,13	61 2,40	CH-12257 ◇	280 11,02	116 4,57	88 3,46 17 0,67	ST05-16108	260 10,24	56 2,20 59 2,32	41 1,61
CH-13811	296 11,65	196 7,72 15 0,59	92,5 3,64 18 0,71	CH-12688	280 11,02	163 6,42 134 5,28	84 3,31 16,5 0,65	ST-12689	260 10,24	82 3,23	64 2,52 12 0,47
CH-12809	292 11,50	150 5,91	71 2,80 10,5 0,41	CH-12775	280 11,02	180 7,09 134 5,28	13,6 0,54 72 2,83	CH10-12224 ◇	256 10,08	251 9,88 202 7,95	91 3,58 13,5 0,53
CH-12288 ◇	290 11,42	226 8,90	117 4,61 11 0,43	ST-12226	280 11,02	92,5 3,64 75 2,95	62 2,44 17 0,67	CH-12272 ◇	256 10,08	86 3,39	56 2,20 17 0,67
CH-12485	290 11,42	74 2,91	48 1,89 8,5 0,33	CH-12752	279 10,98	234 9,21	124 4,88 16,5 0,65	CH-13623	255 10,04	150 5,91 104 4,09	7 0,28 63 2,48
CH-13074	290 11,42	180 7,09 140 5,51	7/16 UNF-20 72 2,83	ST-15400	278 10,94	75 2,95	62 2,44 11 0,43	ST-15557	255 10,04	77 3,03 66 2,60	56 2,20 8,5 0,33
SC06-11252	290 11,42	90 3,54	60 2,36 8,5 0,33	DL-17329	276 10,87	216 8,50	76 2,99	CH08-12221	254 10,00	197 7,76 155 6,10	88 3,46 19 0,75
SC08-11253	290 11,42	90 3,54 60 2,36	60 2,36 8,5 0,33	CH-12826	275 10,83	213 8,39 235 9,25	105 4,13 9 0,35	CH12-12251	254 10,00	296 11,65 234,5 9,23	122,5 4,82 17 0,67

Filter Listing by Dimension (Cont.)

L'altezza non include la guarnizione/ Height not include gasket
 O.D. = diam. est. I.D. = diam. int.
 * = Cartuccia in rete metallica / Metallic net element
 ◇ = Cartuccia con termini di consegna a richiesta / Element with lead time to agree



Part.No.	Height mm. inch	O.D. mm. inch	I.D. mm. inch	Part.No.	Height mm. inch	O.D. mm. inch	I.D. mm. inch	Part.No.	Height mm. inch	O.D. mm. inch	I.D. mm. inch
CH-12207 ◇	254 10,00	213 8,39	103 4,06	CH-13296	236 9,29	109,5 4,31 85 3,35	46 1,81 11 0,43	ST-15411	203 7,99	75 2,95	62 2,44 11 0,43
CH-12213 ◇	254 10,00	215 8,46	151 5,94 9,5 0,37	CH-13349	235 9,25	166 6,54	86,5 3,41	CH-11623	202 7,95	170 6,69	91,5 3,60 8 0,31
CH-12770	254 10,00	150 5,91 129 5,08	17 0,67 63 2,48	CH-15425 ◇	231 9,09	120 4,72 137 5,39	77 3,03 10 0,39	CH-11752 *	202 7,95	164 6,46	86 3,39 9 0,35
CH-14047	254 10,00	150 5,91 104 4,09	14 0,55 63 2,48	ST-12223 ◇	230 9,06	94 3,70 75 2,95	85 3,35 17 0,67	CH-12599 ◇	202 7,95	164 6,46	86 3,39 8,5 0,33
CH-15512	254 10,00	150 5,91 104 4,09	7 0,28 63 2,48	CH-13510	230 9,04	108 4,25 115 4,53	67 2,64 9,5 0,37	CH-13423 *	202 7,95	163 6,42	98 3,86 8,5 0,33
ST-14343	254 10,00	79 3,11 64,5 2,54	56 2,20 17 0,67	CH-12262 ◇	229 9,00	264,4 10,41	153 6,02 17 0,67	CH-14928 *	202 7,95	164 6,46	86 3,39 9 0,35
CH05-11106	253 9,96	130 5,12 104 4,09	63 2,48 18 0,71	CH05-12222	228 8,98	132 5,20 104 4,09	63 2,48 19 0,75	CH-11731	200 7,87	183 7,20	M6 120 4,72
CH05-14827	253 9,96	104 4,09	63 2,48 18 0,71	CH-14015	228 8,98	104 4,09 130 5,12	63 2,48 19 0,75	CH-12091	200 7,87	164 6,46	86 3,39
CH-12275 ◇	253 9,96	224 8,82 174 6,85	107 4,21 17 0,67	CH-12285	226 8,90	165 6,50	86,5 3,41	CH-12211 ◇	200 7,87	88 3,46	50 1,97
CH-12716	253 9,96	146 5,75 104 4,09	7 0,28 64,5 2,54	CH08-11998	225 8,86	197 7,76 155 6,10	88 3,46 19 0,75	CH-12220 ◇	200 7,87	168 6,61	100 3,94
CH-14393	253 9,96	130 5,12 104 4,09	63 2,48 18 0,71	CH-12287	225 8,86	126 4,96	65 2,56	CH-13562	200 7,87	183 7,20	120 4,72 9,5 0,37
CH-16878	253 9,96	115 4,53	64 2,52	CH-13644	224 8,82	126 4,96	126 4,96 65 2,56	CH-13933	200 7,87	234 9,21	133 5,24 16,5 0,65
ST06-12048	251 9,88	92,5 3,64 70 2,76	62 2,44 17 0,67	CH-10689	223 8,78	183 7,20	106 4,17 9,5 0,37	CH-14536	200 7,87	234 9,21	133 5,24 16,5 0,65
CH-12403	250 9,84	485 19,09	335 13,19	CH-14214	220 8,66	120 4,72	70 2,76 6,5 0,26	CH-14735	200 7,87	183 7,20	120 4,72 9,5 0,37
CH-12667 ◇	250 9,84	485 19,09	335 13,19	CH-16874	220 8,64	334 13,15	205 8,07	ST-16880	200 7,85	68 2,68 80 3,15	9 0,35 66 2,60
CH-13185	250 9,84	150 5,91 174 6,85	71 2,80 M10 x 1,5	CH-11789	218 8,58	150 5,91	72 2,83 11 0,43	DL-17331	199 7,83	216 8,50	64 2,52
CH-14022 ◇	250 9,84	138 5,43	76 2,99 11 0,43	CH-11712	217 8,54	234 9,21	124 4,88 15 0,59	CH-14063	198 7,80	67 2,64 111 4,37	50 1,97
CH-18461	250 9,84	308 12,13	195 7,68 17 0,67	CH-12239	217 8,54	242 9,53	132 5,20	CH-12817	197 7,76	150 5,91	71 2,80 12,5 0,49
CH-12246 ◇	244 9,61	276 10,87 333 13,11	133 5,24 11 0,43	CH-12397	217 8,54	109 4,29	52 2,05 8,5 0,33	CH-13506	197 7,76	121 4,76	75 2,95 9,5 0,37
CH-12247 ◇	244 9,61	327 12,87 383 15,08	167 6,57 11 0,43	CH-14257	217 8,54	234 9,21	133 5,24 15 0,59	CH-12216 ◇	195 7,68	222 8,74	154 6,06
ST-16872	243 9,57	62 2,44	52 2,05 11 0,43	CH-11513 ◇	215 8,46	140 5,51	94 3,70	ST-16879	191 7,52	85 3,35 82,5 3,25	8 0,31
ST05-11108	242 9,53	62 2,44	52 2,05 8,5 0,33	CH-14152	210 8,27	110 4,33	63 2,48	CH05-12202	190 7,48	130 5,12 104 4,09	63 2,48 19 0,75
CH-12181	240 9,45	83 3,27	54 2,13 16,5 0,65	CH-13520	209 8,23	66 2,60	41 1,61 8,5 0,33	CH-11219	190 7,48	104 4,09 130 5,12	63 2,48 19 0,75
ST-17260	240 9,45	92,5 3,64 70 2,76	62 2,44 8,5 0,33	ST05-14980	209 8,23	60,7 2,39 115,5 4,55	17 0,67 48,5 1,91	CH-13300	189 7,44	155 6,10	88 3,46 18 0,71
ST-16877	238 9,35	57 2,24 54,5 2,15	42 1,65	CH-12250 ◇	208 8,19	333,7 13,14	204 8,03	CH-13597	189 7,44	150 5,91 140 5,51	7 0,28 63 2,48
CH-10677	237 9,33	164 6,46	86 3,39 8,5 0,33	CH-11371 ◇	205 8,07	164 6,46	86 3,39 8,5 0,33	CH-14211	189 7,44	196 7,72 155 6,10	88 3,46 18 0,71
CH-13294	236 9,29	127 5,00 83 3,27	6 0,24 46 1,81	CH-13579	205 8,07	164 6,46	86 3,39 9 0,35	ST08-12459	188 7,40	85 3,35	72 2,83 10,2 0,40

Filter Listing by Dimension (Cont.)

L'altezza non include la guarnizione/ Height not include gasket
 O.D. = diam. est. I.D. = diam. int.
 * = Cartuccia in rete metallica / Metallic net element
 ◇ = Cartuccia con termini di consegna a richiesta / Element with lead time to agree



Part.No.	Height mm. inch	O.D. mm. inch	I.D. mm. inch	Part.No.	Height mm. inch	O.D. mm. inch	I.D. mm. inch	Part.No.	Height mm. inch	O.D. mm. inch	I.D. mm. inch
ST-14758	188 7,40	85 3,35	74 2,91 10,2 0,40	CH08-11837	150 5,91	155 6,10	88 3,46 19 0,75	CH-17512	104 4,09	98 3,86	60 2,36
DL-17823	186 7,32	267 10,51	100 3,94	PF-14910	150 5,91	350 13,78	450 17,72	CH-16384	102 4,02	101 3,98	67 2,64
ST-12106	186 7,32	106 4,17 85 3,35	74 2,91 10,2 0,40	PF-15015	150 5,91	450 17,72	475 18,70	CH-15005	101 3,98	203 7,99	98 3,86
CH04-14412	184 7,24	89 3,50	46 1,81	PF-15695 ◇	150 5,91	450 17,72	450 17,72	CH-11603	100 3,94	120 4,72	M6 70 2,76
CH-13177	180 7,09	90 3,54	60 2,36 8,5 0,33	DL-17606	147 5,79	132 5,20	76 2,99	CH-11716	100 3,94	120 4,72	65 2,56 6,5 0,26
CH04-15145	179 7,05	89 3,50	41 1,61	CH-12713	146 5,75	80 3,15 204 8,03	78,8 3,10	CH-13366 ◇	100 3,94	183 7,20	107 4,21 9,5 0,37
CH-12739	178 7,01	128 5,04 109 4,29	10,5 0,41 43 1,69	CH05-11555	145 5,71	131 5,16 104 4,09	63 2,48 18 0,71	CH-12177	96 3,78	210 8,27	149,4 5,88
CH-12694	177 6,97	127 5,00 83 3,27	6 0,24 46 1,81	CH-11929	145 5,71	120 4,72	70 2,76 6,5 0,26	CH-14425	96 3,78	164 6,46	86 3,39 9 0,35
CH-15267	177 6,97	107 4,21 83 3,27	54 2,13 16,5 0,65	CH-13982	145 5,71	120 4,72	70 2,76 6,5 0,26	CH-14738 *	96 3,78	164 6,46	86 3,39 9 0,35
CH04-11675	175 6,89	109,5 4,31 83 3,27	46 1,81 10 0,39	CH-15310 *	143 5,63	120 4,72	80 3,15 6,5 0,26	CH-11360	95 3,74	183 7,20	M6 107 4,21
ST-14787	175 6,89	92,5 3,64 70 2,76	62 2,44 17 0,67	CH-12105 ◇	136 5,35	176 6,93	144 5,67	CH-11622	95 3,74	183 7,20	106 4,17 9,5 0,37
ST04-15170	173 6,81	45 1,77	35 1,38	DL-17333	136 5,35	216 8,50	64 2,52	CH-12291	95 3,74	120 4,72	70 2,76 9 0,35
CH-14111	171 6,73	160 6,30 74,5 2,93	60,5 2,38	DL-17710	136 5,35	165 6,50	51 2,01	CH-12474	95 3,74	140 5,51	94 3,70
CH-16284	169 6,65	83 3,27 83 3,27	46 1,81 46 1,81	CH-15788	135 5,31	186 7,32	133,5 5,26	CH-12598	95 3,74	183 7,20	106 4,17 M6
CH-13310	165 6,50	85 3,35	56 2,20 17 0,67	CH-17542	135 5,31	117,5 4,63	67 2,64	CH-16378	95 3,74	183 7,20	M6 107 4,21
CH-13835	165 6,50	160 6,30 91 3,58	77 3,03	ST05-11618	134 5,28	62 2,44	52 2,05 8,5 0,33	CH-11758 *	94 3,70	120 4,72	80 3,15 6,5 0,26
DL-16097	165 6,50	160 6,30	77 3,03	PF-14090	133 5,24	380 14,96	382 15,04	CH-12818 *	94 3,70	183 7,20	106 4,17 9,5 0,37
CH-12870	164 6,46	126 4,96	65 2,56 9 0,35	PFM-14095	133 5,24	380 14,96	382 15,04	CH-12463	92 3,62	210 8,27	165 6,50
CH-12215 ◇	163 6,42	136 5,35	102 4,02	CH-12206 ◇	123 4,84	138 5,43	81 3,19	CH-12532	92 3,62	215 8,46	146 5,75
CH-12985	163 6,42	93 3,66	44 1,73 8,5 0,33	DL-17604	123 4,84	112 4,41	62 2,44	CH-13467	92 3,62	215 8,46	146 5,75
CH-13297	161 6,34	90,5 3,56	41,5 1,63 7 0,28	CH-12843	121 4,76	277 10,91	157 6,18	CH-18090	87 3,43	136 5,35	78 3,07
DL-17330	161 6,34	165 6,50	57 2,24	CH-11063	120 4,72	69 2,72	26 1,02	CH-12233 ◇	85 3,35	170 6,69	116 4,57
CH-12888	160 6,30	104 4,09	63 2,48 8,5 0,33	CH-13115	120 4,72	112 4,41 66,5 2,62	50 1,97	PF-15693	80 3,15	597 23,50	172 6,77
ST-15255	158 6,22	51 2,01 55 2,17	16,5 0,65 40 1,57	CH-12712	119 4,69	49 1,93 148 5,83	47,8 1,88	PF-15700	80 3,15	320 12,60	278 10,94
CH-13947	156 6,14	140 5,51 280 11,02	138 5,43	CH-14746 ◇	111 4,37	54 2,13 120 4,72	40 1,57	CH-11958	79 3,11	140 5,51	94 3,70
CH-13116	151 5,94	130 5,12 88,5 3,48	76 2,99	CH-12249 ◇	110 4,33	301,5 11,87	190,5 7,50	CH-17541	79 3,11	100 3,94	67 2,64
CH08-11730	150 5,91	197 7,76 155 6,10	88 3,46 19 0,75	DL-17852	110 4,33	216 8,50	76 2,99	CH-13489	78 3,07	207 8,15	153 6,02

Filter Listing by Dimension (Cont.)

L'altezza non include la guarnizione/ Height not include gasket
 O.D. = diam. est. I.D. = diam. int.
 * = Cartuccia in rete metallica / Metallic net element
 ◇ = Cartuccia con termini di consegna a richiesta / Element with lead time to agree



Part.No.	Height mm. inch	O.D. mm. inch	I.D. mm. inch	Part.No.	Height mm. inch	O.D. mm. inch	I.D. mm. inch	Part.No.	Height mm. inch	O.D. mm. inch	I.D. mm. inch
CH-15633	77 3,03	76 2,99	34 1,34	PF-16185	56 2,20	470 18,50	116 4,57	PF-15686	44 1,73	270 10,63	186 7,32
CH-14950	76 2,99	160 6,30	120 4,72	CH-11210	55 2,17	140 5,51	94 3,70	◇			
CH-12847	74 2,91	199 7,83	105 4,13	PF-15688	55 2,17	602 23,70	110 4,33	PF-15683	42 1,65	205 8,07	133,6 5,26
CH-14006	74 2,91	207 8,15	153 6,02	PF-15860	55 2,17	400 15,75	130 5,12	◇			
CH-16888	72,5 2,85	Dim. 98 x 142	8 0,31	◇				PF-15684	41,6 1,64	273 10,75	133,3 5,25
CH-11463	71 2,80	140 5,51	94 3,70	PF-15861	55 2,17	600 23,62	90 3,54	◇			
CH-12953	70 2,76	98 3,86	60 2,36	PF-15862	55 2,17	590 23,23	100 3,94	PF-17844	37,5 1,48	500 19,69	174 6,85
PF-15699	70 2,76	320 12,60	278 10,94	◇				PF-15680	30,5 1,20	323 12,72	123,5 4,86
PF-15706	70 2,76	332 13,07	266 10,47	PF-15864	55 2,17	500 19,69	140 5,51	PF-15855	26 1,02	63 2,48	90 3,54
◇				◇				◇			
CH-17539	69 2,72	60 2,36	34,5 1,36	PF-15866	55 2,17	400 15,75	355 13,98	PF-15863	24 0,94	250 9,84	301 11,85
PF-15890	69 2,72	450 17,72	150 5,91	◇				◇			
◇				CH-11649	52 2,05	89 3,50	64 2,52	PF-15660	21 0,83	75 2,95	75 2,95
PF-15890	69 2,72	450 17,72	150 5,91	◇				*			
◇				CH-14037	52 2,05	89 3,50	47 1,85	PF-16805	21 0,83	75 2,95	75 2,95
CH-11348	68 2,68	140 5,51	94 3,70	◇							
CH-12839	67 2,64	132,5 5,22	78 3,07	PF-15672	51,5 2,03	317 12,48	262 10,31	PF-15856	20,6 0,81	132,6 5,22	112,7 4,44
CH-12150	66 2,60	168 6,61	108 4,25	◇							
CH-12135	64 2,52	210 8,27	165 6,50	PF-16738	51 2,01	179 7,05	183 7,20				
PF-18174	63,5 2,50	360 14,17	263 10,35	PF-16800	51 2,01	88 3,46	89 3,50				
PF-15669	62 2,44	311 12,24	241 9,49	PF-16803	51 2,01	142,5 5,61	142,5 5,61				
◇				PF-15679	50 1,97	182 7,17	182 7,17				
PF-15877	62 2,44	597 23,50	172 6,77	◇				PF-15701	50 1,97	519,5 20,45	104 4,09
◇				PF-15859	50 1,97	300 11,81	169 6,65				
PF-15891	61 2,40	880 34,65	135 5,31	◇				PF-15888	50 1,97	585 23,03	180 7,09
CH-14245	60 2,36	120 4,72	70 2,76	PF-18559	50 1,97	380 14,96	130 5,12	◇			
PF-15470	60 2,36	497 19,57	497 19,57	CH-13500	48 1,89	242 9,53	194 7,64				
PF-15690	60 2,36	597 23,50	172 6,77	PF-15441	48 1,89	210 8,27	210 8,27				
PF-17644	58 2,28	275 10,83	142 5,59	PF-15858	48 1,89	280 11,02	120 4,72				
PF-15671	57,5 2,26	278 10,94	179,5 7,07	◇				PF-15857	47 1,85	88,5 3,48	135 5,31
CH-11761	56 2,20	134 5,28	92,5 3,64	CH-15696	46 1,81	135 5,31	54 2,13				
*				CH-18334	46 1,81	120 4,72	80 3,15				
PF-15677	56 2,20	609 23,98	609 23,98	PF-15686	44 1,73	270 10,63	186 7,32				
				◇							

Le informazioni contenute in questo catalogo, sono state inserite con la massima attenzione. La Virgis Filter si riserva il diritto di modificare le specifiche tecniche ed altri dati senza alcun preavviso.

The informations, contained in this catalog, are insert with maximun attention. Virgis Filter reserves the right to make any changes without prior notification. Therefore technical data are subject to modifications.